



AMG1312-T Series

Wireless N ADSL2+ 4-port Gateway with USB

Version 2.00
Edition 1, 8/2013

User's Guide

Default Login Details

LAN IP Address	http://192.168.1.1
User Name	admin
Password	1234

IMPORTANT!

READ CAREFULLY BEFORE USE.

KEEP THIS GUIDE FOR FUTURE REFERENCE.

Note: This guide is a reference for a series of products. Therefore some features or options in this guide may not be available in your product.

Graphics in this book may differ slightly from the product due to differences in operating systems, operating system versions, or if you installed updated firmware/software for your device. Every effort has been made to ensure that the information in this manual is accurate.

Related Documentation

- Quick Start Guide

The Quick Start Guide shows how to connect the AMG1312-T Series and access the Web Configurator. It contains information on setting up your wireless network.

Contents Overview

User's Guide	12
Introduction	14
Introducing the Web Configurator	19
Internet / Wireless Setup Wizard.....	27
Tutorials	34
Technical Reference	61
Connection Status and System Info Screens	63
Broadband	68
Wireless LAN	87
Home Networking	115
Static Route	132
Quality of Service (QoS)	136
Network Address Translation (NAT)	147
Port Binding	157
Dynamic DNS Setup	161
Filters	163
Firewall	168
Parental Control	186
Certificate	189
Logs	194
Traffic Status	196
User Account	199
TR-069 Client	200
System Settings	202
Firmware Upgrade	205
Backup/Restore	207
Remote Management	210
Diagnostic	221
Troubleshooting	224

Table of Contents

Contents Overview	3
Table of Contents	4
Part I: User's Guide	12
Chapter 1	
Introduction.....	14
1.1 Overview	14
1.2 Ways to Manage the AMG1312-T Series	14
1.3 Good Habits for Managing the AMG1312-T Series	14
1.4 Applications for the AMG1312-T Series	15
1.4.1 Internet Access	15
1.4.2 Wireless Access	15
1.5 General Hardware Features	16
1.6 Using the WPS Button	17
1.7 The RESET Button	18
1.7.1 Using the Reset Button	18
1.8 Ways to Manage the AMG1312-T Series	18
Chapter 2	
Introducing the Web Configurator	19
2.1 Overview	19
2.1.1 Accessing the Web Configurator	19
2.2 The Web Configurator Layout	22
2.2.1 Title Bar	23
2.2.2 Main Window	24
2.2.3 Navigation Panel	24
Chapter 3	
Internet / Wireless Setup Wizard	27
3.1 Overview	27
3.2 Internet / Wireless Wizard Setup	27
Chapter 4	
Tutorials.....	34
4.1 Overview	34
4.2 Setting Up Your DSL Connection	34

4.3 IPv6 Address Configuration	36
4.4 Setting Up a Secure Wireless Network	37
4.4.1 Configuring the Wireless Network Settings	37
4.4.2 Using WPS	38
4.4.3 Connecting Wirelessly to your AMG1312-T Series	42
4.5 Configuring the MAC Address Filter for Restricting Wireless Internet Access	44
4.6 Setting Up NAT Forwarding for a Game Server	45
4.6.1 Port Forwarding	46
4.7 Configuring Firewall Rules to Allow a Specified Service	47
4.8 Configuring Static Route for Routing to Another Network	50
4.9 Port Binding Configuration	52
4.9.1 Configuring ATM QoS for Multiple WAN Connections	52
4.9.2 Configuring Port Binding	55
4.10 Configuring QoS to Prioritize Traffic	56
4.11 Access the AMG1312-T Series from the Internet Using DDNS	59
4.11.1 Registering a DDNS Account on www.dyndns.org	59
4.11.2 Configuring DDNS on Your AMG1312-T Series	60
4.11.3 Testing the DDNS Setting	60

Part II: Technical Reference..... 61

Chapter 5

Connection Status and System Info Screens 63

5.1 Overview	63
5.2 The Connection Status Screen	63
5.3 The System Info Screen	64

Chapter 6

Broadband..... 68

6.1 Overview	68
6.1.1 What You Can Do in the WAN Screens	68
6.1.2 What You Need to Know About WAN	68
6.1.3 Before You Begin	69
6.2 The Internet Connection Screen	69
6.2.1 Advanced Setup	73
6.3 The More Connections Screen	75
6.3.1 More Connections Edit	76
6.3.2 Configuring More Connections Advanced Setup	79
6.4 The 3G Backup Screen	80
6.5 WAN Technical Reference	82
6.5.1 Encapsulation	82

6.5.2 Multiplexing	83
6.5.3 VPI and VCI	84
6.5.4 IP Address Assignment	84
6.5.5 Nailed-Up Connection (PPP)	84
6.5.6 NAT	85
6.6 Traffic Shaping	85
6.6.1 ATM Traffic Classes	86

Chapter 7
Wireless LAN.....87

7.1 Overview	87
7.1.1 What You Can Do in the Wireless LAN Screens	87
7.1.2 What You Need to Know About Wireless	88
7.1.3 Before You Start	88
7.2 The General Screen	88
7.2.1 No Security	90
7.2.2 Basic (WEP Encryption)	90
7.2.3 More Secure (WPA(2)-PSK)	91
7.2.4 WPA(2) Authentication	92
7.3 The More/Guest AP Screen	94
7.3.1 More AP Edit	94
7.4 The MAC Authentication Screen	96
7.5 The WPS Screen	97
7.6 The WDS Screen	99
7.7 The WMM Screen	100
7.8 The Scheduling Screen	100
7.9 The Advanced Screen	101
7.10 Wireless LAN Technical Reference	102
7.10.1 Wireless Network Overview	102
7.10.2 Additional Wireless Terms	104
7.10.3 Wireless Security Overview	104
7.10.4 Signal Problems	106
7.10.5 BSS	107
7.10.6 MBSSID	107
7.10.7 Wireless Distribution System (WDS)	108
7.10.8 WiFi Protected Setup (WPS)	108

Chapter 8
Home Networking..... 115

8.1 Overview	115
8.1.1 What You Can Do in the LAN Screens	115
8.1.2 What You Need To Know	116
8.1.3 Before You Begin	117

8.2 The LAN Setup Screen	117
8.3 The Static DHCP Screen	119
8.4 The IP Alias Screen	120
8.4.1 Configuring the LAN IP Alias Screen	121
8.5 The UPnP Screen	121
8.6 The IPv6 LAN Setup Screen	122
8.7 The File Sharing Screen	125
8.7.1 The User Edit Screen	126
8.8 Home Networking Technical Reference	128
8.8.1 LANs, WANs and the AMG1312-T Series	128
8.8.2 DHCP Setup	128
8.8.3 DNS Server Addresses	128
8.8.4 LAN TCP/IP	129
8.8.5 RIP Setup	130
8.8.6 Multicast	130
Chapter 9	
Static Route	132
9.1 Overview	132
9.1.1 What You Can Do in the Static Route Screens	133
9.2 The Static Route Screen	133
9.2.1 Static Route Add/Edit	133
9.3 IPv6 Static Route	134
9.3.1 IPv6 Static Route Edit	135
Chapter 10	
Quality of Service (QoS).....	136
10.1 Overview	136
10.1.1 What You Can Do in the QoS Screens	136
10.1.2 What You Need to Know About QoS	137
10.2 The Quality of Service General Screen	137
10.3 The Queue Screen	138
10.3.1 Adding a QoS Queue	139
10.4 The Class Setup Screen	140
10.4.1 Class Setup Add/Edit	140
10.5 The QoS Game List Screen	144
10.6 QoS Technical Reference	145
10.6.1 IEEE 802.1p	145
10.6.2 IP Precedence	145
10.6.3 Automatic Priority Queue Assignment	146
Chapter 11	
Network Address Translation (NAT).....	147

11.1 Overview	147
11.1.1 What You Can Do in the NAT Screens	147
11.1.2 What You Need To Know About NAT	147
11.2 The NAT General Screen	148
11.3 The Port Forwarding Screen	149
11.3.1 Configuring the Port Forwarding Screen	149
11.3.2 Port Forwarding Rule Add/Edit	150
11.4 The DMZ Screen	152
11.5 The ALG Screen	152
11.6 NAT Technical Reference	153
11.6.1 NAT Definitions	153
11.6.2 What NAT Does	154
11.6.3 How NAT Works	154
11.6.4 NAT Application	154
11.6.5 NAT Mapping Types	155
Chapter 12	
Port Binding	157
12.1 Overview	157
12.1.1 What You Can Do in the Port Binding Screens	158
12.2 The Port Binding General Screen	158
12.3 The Port Binding Screen	158
12.3.1 Port Binding Summary Screen	159
Chapter 13	
Dynamic DNS Setup	161
13.1 Overview	161
13.1.1 What You Can Do in the DDNS Screen	161
13.1.2 What You Need To Know About DDNS	161
13.2 The Dynamic DNS Screen	161
Chapter 14	
Filters	163
14.1 Overview	163
14.1.1 What You Can Do in the Filter Screens	163
14.1.2 What You Need to Know About Filtering	163
14.2 The IP/MAC Filter Screen	163
14.3 IPv6/MAC Filter	166
Chapter 15	
Firewall	168
15.1 Overview	168
15.1.1 What You Can Do in the Firewall Screens	168

15.1.2 What You Need to Know About Firewall	169
15.2 The Firewall General Screen	170
15.3 The Default Action Screen	171
15.4 The Rules Screen	173
15.4.1 The Rules Add Screen	174
15.4.2 Customized Services	176
15.4.3 Customized Service Add/Edit	177
15.5 The DoS Screen	179
15.5.1 The DoS Advanced Screen	179
15.5.2 Configuring Firewall Thresholds	180
15.6 Firewall Technical Reference	181
15.6.1 Firewall Rules Overview	181
15.6.2 Guidelines For Enhancing Security With Your Firewall	182
15.6.3 Security Considerations	183
15.6.4 Triangle Route	183
Chapter 16	
Parental Control	186
16.1 Overview	186
16.2 The Parental Control Screen	186
16.2.1 Add/Edit Parental Control Rule	187
Chapter 17	
Certificate	189
17.1 Overview	189
17.1.1 What You Can Do in this Chapter	189
17.2 What You Need to Know	189
17.3 Local Certificates	189
17.4 The Trusted CA Screen	191
17.5 Trusted CA Import	191
17.6 View Certificate	192
Chapter 18	
Logs	194
18.1 Overview	194
18.1.1 What You Can Do in this Chapter	194
18.1.2 What You Need To Know	194
18.2 The System Log Screen	195
Chapter 19	
Traffic Status	196
19.1 Overview	196
19.1.1 What You Can Do in this Chapter	196

19.2 The WAN Status Screen	196
19.3 The LAN Status Screen	197
19.4 The NAT Screen	198
Chapter 20	
User Account	199
20.1 Overview	199
20.2 The User Account Screen	199
Chapter 21	
TR-069 Client.....	200
21.1 Overview	200
21.2 The TR-069 Client Screen	200
Chapter 22	
System Settings.....	202
22.1 Overview	202
22.1.1 What You Can Do in the System Settings Screens	202
22.2 The System Screen	202
22.3 The Time Screen	202
Chapter 23	
Firmware Upgrade	205
23.1 Overview	205
23.2 The Firmware Screen	205
Chapter 24	
Backup/Restore	207
24.1 Overview	207
24.2 The Backup/Restore Screen	207
24.3 The Reboot Screen	209
Chapter 25	
Remote Management.....	210
25.1 Overview	210
25.1.1 What You Can Do in the Remote Management Screens	210
25.1.2 What You Need to Know About Remote Management	211
25.2 The WWW Screen	211
25.2.1 Configuring the WWW Screen	211
25.3 The Telnet Screen	213
25.4 The FTP Screen	213
25.5 The SNMP Screen	214
25.5.1 Configuring SNMP	215

25.6 The DNS Screen	217
25.7 The ICMP Screen	217
25.8 The SSH Screen	218
25.8.1 SSH Example	219
Chapter 26	
Diagnostic	221
26.1 Overview	221
26.1.1 What You Can Do in the Diagnostic Screens	221
26.2 The General Screen	221
26.3 The DSL Line Screen	222
Chapter 27	
Troubleshooting.....	224
27.1 Power, Hardware Connections, and LEDs	224
27.2 AMG1312-T Series Access and Login	225
27.3 Internet Access	227
Appendix A Setting up Your Computer's IP Address.....	229
Appendix B IP Addresses and Subnetting.....	249
Appendix C Pop-up Windows, JavaScripts and Java Permissions	257
Appendix D Wireless LANs.....	264
Appendix E IPv6	277
Appendix F Services.....	286
Appendix G Legal Information	290
Index	294

PART I

User's Guide

Introduction

1.1 Overview

The AMG1312-T Series is an ADSL2+ router. By integrating DSL and NAT, you are provided with ease of installation and high-speed, shared Internet access. The AMG1312-T Series is also a complete security solution with a robust firewall and content filtering.

Only use firmware for your AMG1312-T Series's specific model. Refer to the label on the bottom of your AMG1312-T Series.

Note: Not all models have all of the features shown in this User's Guide.

1.2 Ways to Manage the AMG1312-T Series

Use any of the following methods to manage the AMG1312-T Series.

- Web Configurator. This is recommended for everyday management of the AMG1312-T Series using a (supported) web browser.
- Command Line Interface. Line commands are mostly used for troubleshooting by service engineers.
- FTP for firmware upgrades and configuration backup/restore.
- TR-069. This is an auto-configuration server used to remotely configure your device.

1.3 Good Habits for Managing the AMG1312-T Series

Do the following things regularly to make the AMG1312-T Series more secure and to manage the AMG1312-T Series more effectively.

- Change the password. Use a password that's not easy to guess and that consists of different types of characters, such as numbers and letters.
- Write down the password and put it in a safe place.
- Back up the configuration (and make sure you know how to restore it). Restoring an earlier working configuration may be useful if the device becomes unstable or even crashes. If you forget your password, you will have to reset the AMG1312-T Series to its factory default settings. If you backed up an earlier configuration file, you would not have to totally re-configure the AMG1312-T Series. You could simply restore your last configuration.

1.4 Applications for the AMG1312-T Series

Here are some example uses for which the AMG1312-T Series is well suited.

1.4.1 Internet Access

Your AMG1312-T Series provides shared Internet access by connecting the DSL port to the **DSL** or **MODEM** jack on a splitter or your telephone jack. Computers can connect to the AMG1312-T Series's Ethernet ports (or wirelessly).

Figure 1 AMG1312-T Series's Router Features

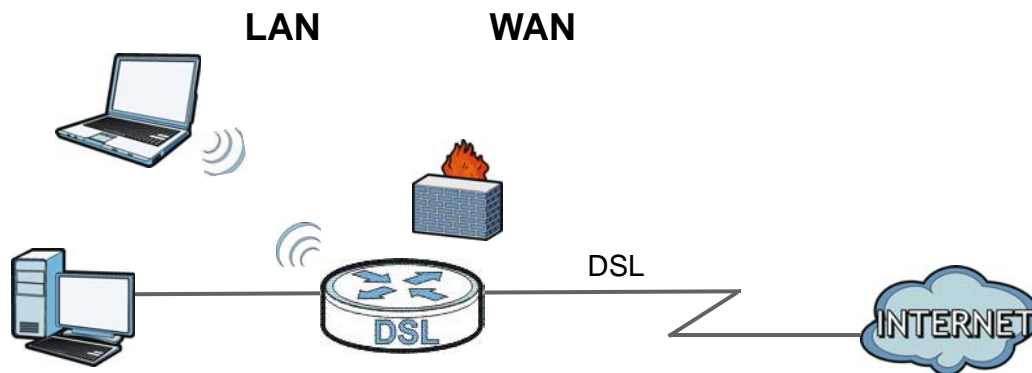

You can also configure firewall and filtering feature on the AMG1312-T Series for secure Internet access. When the firewall is on, all incoming traffic from the Internet to your network is blocked unless it is initiated from your network. This means that probes from the outside to your network are not allowed, but you can safely browse the Internet and download files.

Use the filtering feature to block access to specific web sites or Internet applications such as MSN or Yahoo Messenger. You can also configure IP/MAC filtering rules for incoming or outgoing traffic.

Use QoS to efficiently manage traffic on your network by giving priority to certain types of traffic and/or to particular computers. For example, you could make sure that the AMG1312-T Series gives voice over Internet calls high priority, and/or limit bandwidth devoted to the boss's excessive file downloading.

1.4.2 Wireless Access

The ZyXEL Device is a wireless Access Point (AP) for IEEE 802.11b/g/n compliant clients, such as notebook computers or PDAs and iPads. It allows them to connect to the Internet without having to rely on inconvenient Ethernet cables. You can set up a wireless network with WPS (WiFi Protected Setup) or manually add a client to your wireless network.

Figure 2 Wireless Access Example

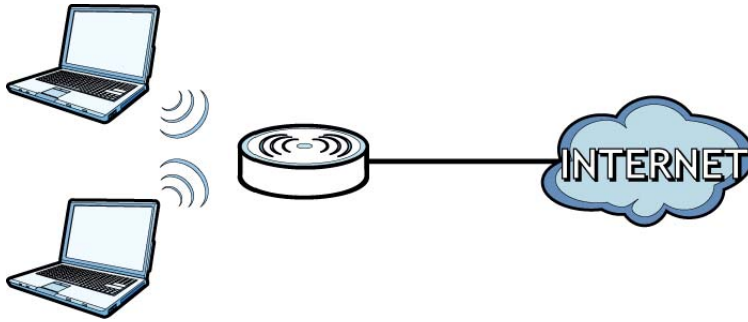

1.5 General Hardware Features

Figure 3 General Hardware Features

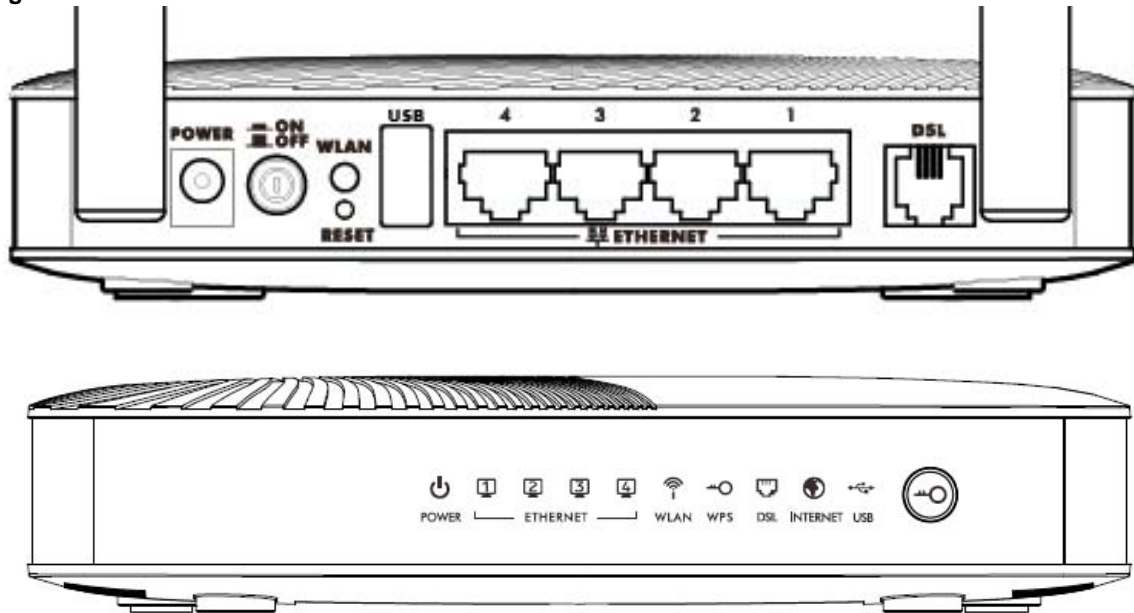

The following table describes the LEDs.

Table 1 LED Descriptions







LED	COLOR	STATUS	DESCRIPTION
 (POWER)	Green	On	The AMG1312-T Series is receiving power and ready for use.
		Blinking	The AMG1312-T Series is self-testing.
	Red	On	The AMG1312-T Series detected an error while self-testing, or there is a device malfunction.
		Off	The AMG1312-T Series is not receiving power.
Ethernet 1-4	Green	On	The AMG1312-T Series has an Ethernet connection with a device on the Local Area Network (LAN).
		Blinking	The AMG1312-T Series is sending/receiving data to/from the LAN.
	Off	The AMG1312-T Series does not have an Ethernet connection with the LAN.	

Table 1 LED Descriptions (continued)

LED	COLOR	STATUS	DESCRIPTION
 (WLAN)	Green	On	The wireless network is activated.
		Blinking	The AMG1312-T Series is communicating with wireless clients.
	Off	The wireless network is not activated.	
 (WPS)	Green	On	WPS is ready.
		Blinking	The AMG1312-T Series is setting up a WPS connection.
	Off	WPS is disabled or has failed.	
 (DSL)	Green	On	The DSL line is up.
		Blinking	The AMG1312-T Series is initializing the DSL line.
	Off	The DSL line is down.	
 (INTERNET)	Green	On	The AMG1312-T Series has an IP connection but no traffic. Your device has a WAN IP address (either static or assigned by a DHCP server), PPP negotiation was successfully completed (if used) and the DSL connection is up.
		Blinking	The AMG1312-T Series is sending or receiving IP traffic.
	Red	On	The AMG1312-T Series attempted to make an IP connection but failed. Possible causes are no response from a DHCP server, no PPPoE response, PPPoE authentication failed.
	Off	The AMG1312-T Series does not have an IP connection.	
 USB	Green	On	The AMG1312-T Series recognizes a USB connection through the USB slot.
		Blinking	The AMG1312-T Series is sending/receiving data to /from the USB device connected to it.
		Off	The AMG1312-T Series does not detect a USB connection through the USB slot.

1.6 Using the WPS Button

You can also use the **WPS** button to quickly set up a secure wireless connection between the AMG1312-T Series and a WPS-compatible client by adding one device at a time.

To activate WPS:

- 1 Make sure the **POWER** LED is on and not blinking.
- 2 Press the **WPS** button for 1-5 seconds and release it. See below for WPS button location.

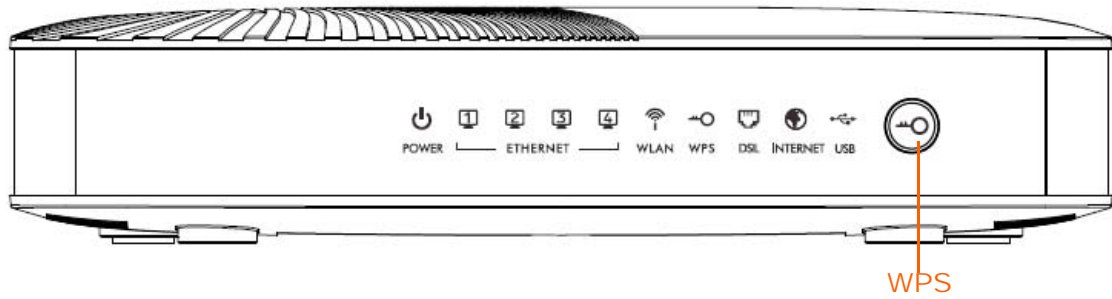

- 3 Press the WPS button on another WPS-enabled device within range of the AMG1312-T Series. The **WPS** LED should flash while the AMG1312-T Series sets up a WPS connection with the other wireless device.
- 4 Once the connection is successfully made, the **WPS** LED shines green.

1.7 The RESET Button

If you forget your password or cannot access the web configurator, you will need to use the **RESET** button at the back of the device to reload the factory-default configuration file. This means that you will lose all configurations that you had previously and the user name and password will be reset to the default.

1.7.1 Using the Reset Button

- 1 Make sure the **POWER** LED is on (not blinking).
- 2 To set the device back to the factory default settings, press the **RESET** button for ten seconds or until the **POWER** LED begins to blink and then release it. When the **POWER** LED begins to blink, the defaults have been restored and the device restarts.

1.8 Ways to Manage the AMG1312-T Series

Use any of the following methods to manage the AMG1312-T Series.

- Web Configurator. This is recommended for everyday management of the AMG1312-T Series using a (supported) web browser.
- FTP for firmware upgrades and configuration backup/restore.

Introducing the Web Configurator

2.1 Overview

The web configurator is an HTML-based management interface that allows easy device setup and management via Internet browser. Use Internet Explorer 6.0 and later versions, Mozilla Firefox 3 and later versions, or Safari 2.0 and later versions. The recommended screen resolution is 1024 by 768 pixels.

In order to use the web configurator, you need to allow:

- Web browser pop-up windows from your device. Web pop-up blocking is enabled by default in Windows XP SP (Service Pack) 2.
- JavaScript (enabled by default).
- Java permissions (enabled by default).

See [Appendix C on page 257](#) if you need to make sure these functions are allowed in Internet Explorer.

2.1.1 Accessing the Web Configurator

- 1 Make sure your AMG1312-T Series hardware is properly connected (refer to the Quick Start Guide).
- 2 Launch your web browser.
- 3 Type "192.168.1.1" as the URL.
- 4 A password screen displays. Type "admin" (default) as the username and "1234" as the password, and click **Login**. If you have changed the password, enter your password and click **Login**.

Figure 4 Password Screen

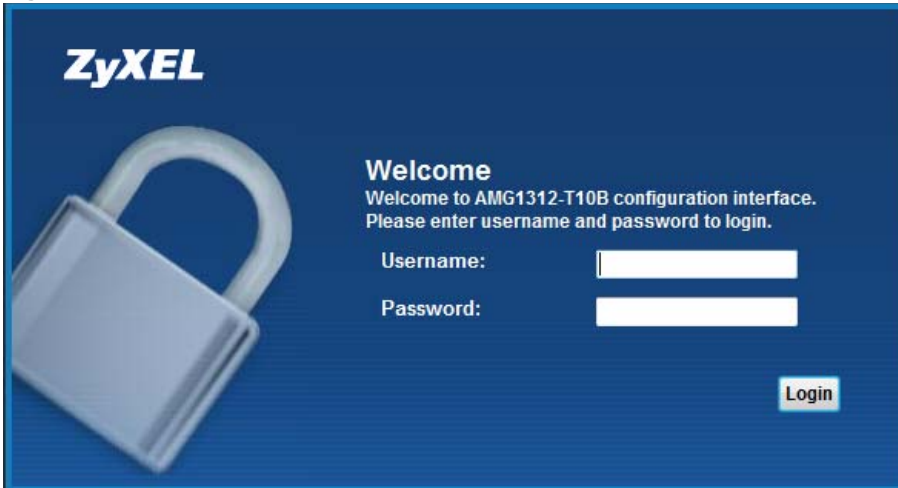

Note: For security reasons, the AMG1312-T Series automatically logs you out if you do not use the web configurator for five minutes (default). If this happens, log in again.

- 5 The following screen displays if you have not yet changed your password. It is strongly recommended you change the default password. Enter a new password, retype it to confirm and click **Apply**; alternatively click **Skip** to proceed to the Connection Status screen if you do not want to change the password now.

Figure 5 Change Password Screen



- 6 The **Connection Status** screen appears.

Figure 6 Connection Status



- 7 Click **System Info** to display the **System Info** screen, where you can view the AMG1312-T Series's interface and system information.

2.2 The Web Configurator Layout

Click **Connection Status > System Info** to show the following screen.

Figure 7 Web Configurator Layout Screen

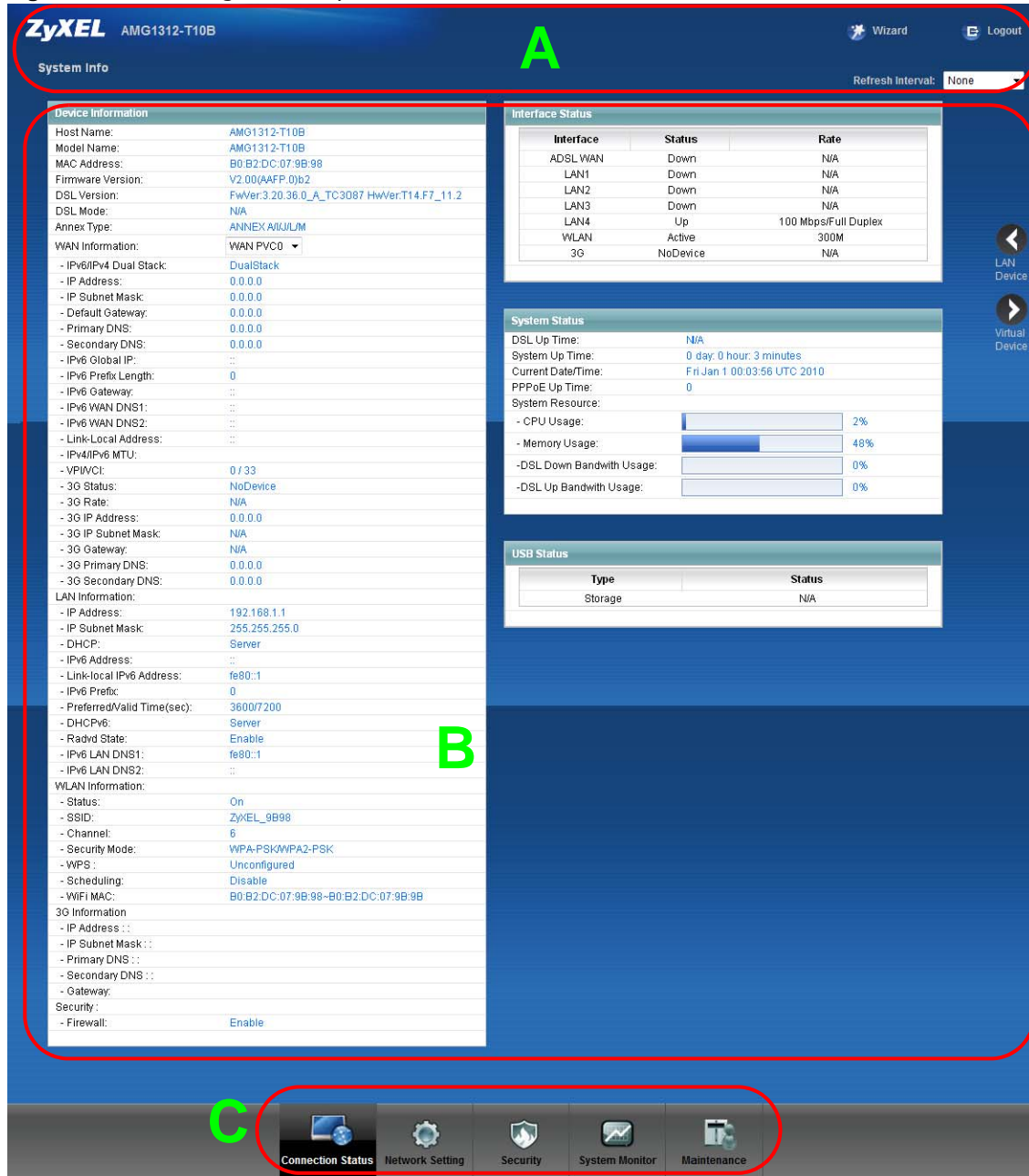

As illustrated above, the main screen is divided into these parts:

- **A** - title bar
- **B** - main window
- **C** - navigation panel

2.2.1 Title Bar

The title bar shows the following icon in the upper right corner. 

Click this icon to log out of the web configurator.

2.2.2 Main Window

The main window displays information and configuration fields. It is discussed in the rest of this document.

After you click **System Info** on the **Connection Status** screen, the **System Info** screen is displayed. See [Chapter 5 on page 64](#) for more information about the **System Info** screen.

If you click **LAN Device** on the **System Info** screen, the **Connection Status** screen appears. See [Chapter 5 on page 63](#) for more information about the **Connection Status** screen.

If you click **Virtual Device** on the **System Info** screen, a visual graphic appears, showing the connection status of the AMG1312-T Series's ports. The connected ports are in color and disconnected ports are gray.

2.2.3 Navigation Panel

Use the menu items on the navigation panel to open screens to configure AMG1312-T Series features. The following table describes each menu item.

Table 2 Navigation Panel Summary

LINK	TAB	FUNCTION
Connection Status		This screen shows the network status of the AMG1312-T Series and computers/devices connected to it.
Network Setting		
Broadband	Internet Connection	Use this screen to configure ISP parameters, WAN IP address assignment, DNS servers and other advanced properties.
	More Connections	Use this screen to configure additional WAN connections.
	3G Backup	Use this screen to configure 3G WAN connection.
Wireless	General	Use this screen to turn the wireless connection on or off, specify the SSID(s) and configure the wireless LAN settings and WLAN authentication/security settings.
	More/guest AP	Use this screen to configure multiple BSSs on the AMG1312-T Series.
	MAC Authentication	Use this screen to block or allow wireless traffic from wireless devices of certain SSIDs and MAC addresses to the AMG1312-T Series.
	WPS	Use this screen to use WPS (Wi-Fi Protected Setup) to establish a wireless connection.
	WDS	Use this screen to set up Wireless Distribution System (WDS) links to other access points.
	WMM	Use this screen to enable or disable Wi-Fi MultiMedia (WMM).
	Scheduling	Use this screen to configure when the AMG1312-T Series enables or disables the wireless LAN.
	Advanced	Use this screen to configure advanced wireless settings such as output power.

Table 2 Navigation Panel Summary (continued)

LINK	TAB	FUNCTION
Home Networking	LAN Setup	Use this screen to configure LAN TCP/IP settings, and other advanced properties.
	Static DHCP	Use this screen to assign specific IP addresses to individual MAC addresses.
	IP Alias	Use this screen to partition your LAN interface into different logical networks.
	UPnP	Use this screen to enable the UPnP function.
	IPv6 LAN Setup	Use this screen to configure the IPv6 settings on the AMG1312-T Series's LAN interface.
	File Sharing	Use this screen to enable file sharing via the Device.
Static Route	Static Route	Use this screen to view and set up static routes on the AMG1312-T Series.
	IPv6 Static Route	Use this screen to configure IPv6 static routes.
QoS	General	Use this screen to enable QoS and decide allowable bandwidth using QoS.
	Queue	Use this screen to configure QoS queue assignment.
	Class Setup	Use this screen to set up classifiers to sort traffic into different flows and assign priority and define actions to be performed for a classified traffic flow.
	Game List	Use this screen to give priority to traffic for specific games.
NAT	General	Use this screen to activate/deactivate NAT.
	Port Forwarding	Use this screen to make your local servers visible to the outside world.
	DMZ	Use this screen to configure a default server which receives packets from ports that are not specified in the Port Forwarding screen.
	ALG	Use this screen to enable or disable SIP ALG.
Port Binding	General	Use this screen to activate/deactivate port binding.
	Port Binding	Use this screen to configure and view port binding groups.
Dynamic DNS	Dynamic DNS	Use this screen to allow a static hostname alias for a dynamic IP address.
Security		
Filter	IP/MAC Filter	Use this screen to configure IPv4/MAC filtering rules for incoming or outgoing traffic.
	IPv6/MAC Filter	Use this screen to configure IPv6/MAC filtering rules for incoming or outgoing traffic.
Firewall	General	Use this screen to activate/deactivate the firewall.
	Default Action	Use this screen to set the default action that the firewall takes on packets that do not match any of the firewall rules.
	Rules	Use this screen to view the configured firewall rules and add, edit or remove a firewall rule.
	Dos	Use this screen to set the thresholds that the AMG1312-T Series uses to determine when to start dropping sessions that are not fully established (half-open sessions).

Table 2 Navigation Panel Summary (continued)

LINK	TAB	FUNCTION
Parental Control	Parental Control	Use this screen to define time periods and days during which the AMG1312-T Series performs parental control and/or block web sites with the specific URL.
Certificates	Local Certificates	Use this screen to export self-signed certificates or certification requests and import the AMG1312-T Series's CA-signed certificates.
	Trusted CA	Use this screen to save CA certificates to the AMG1312-T Series.
System Monitor		
Log	Log	Use this screen to view the logs for the level that you selected. You can export or e-mail the logs.
Traffic Status	WAN	Use this screen to view the status of all network traffic going through the WAN port of the AMG1312-T Series.
	LAN	Use this screen to view the status of all network traffic going through the LAN ports of the AMG1312-T Series.
	NAT	Use this screen to view the status of NAT sessions on the AMG1312-T Series.
Maintenance		
Users Account	Users Account	Use this screen to configure the passwords your user accounts.
TR-069 Client	TR-069 Client	Use this screen to configure the AMG1312-T Series to be managed by an Auto Configuration Server (ACS).
System	System	Use this screen to configure management inactivity time-out setting.
Time	Time Setting	Use this screen to change your AMG1312-T Series's time and date.
Log Setting	Log Setting	Use this screen to select which logs and/or immediate alerts your device is to record. You can also set it to e-mail the logs to you.
Firmware Upgrade	Firmware Upgrade	Use this screen to upload firmware to your device.
Backup/Restore	Backup/Restore	Use this screen to backup and restore your device's configuration (settings) or reset the factory default settings.
Reboot	Reboot	Use this screen to reboot the AMG1312-T Series without turning the power off.
Remote MGMT	WWW, Telnet, FTP, SNMP, DNS, ICMP, SSH	Use this screen to enable specific traffic directions for specific network service.
Diagnostic	Ping	Use this screen to test the connections to other devices.
	DSL Line	Use this screen to identify problems with the DSL connection.

Internet / Wireless Setup Wizard

3.1 Overview

Use the wizard setup screens to configure your system for Internet access with the information given to you by your ISP.

Note: See the advanced menu chapters for background information on these fields.

3.2 Internet / Wireless Wizard Setup

- 1 After you enter the password to access the web configurator, click the Wizard icon () in the top right corner of the web configurator to go to the Wizard.
- 2 Click **INTERNET/WIRELESS SETUP** to configure the system for Internet access and wireless connection.
- 3 Select your **Time Zone** from the drop-down menu, and click **Next**.

Figure 8 Wizard Welcome



Enter your Internet access information in the wizard screen exactly as your service provider gave it to you. Leave the defaults in any fields for which you were not given information.

- 4 Configure the field and click **Next** to continue. See [Section 3.2 on page 27](#) for wireless connection wizard setup.

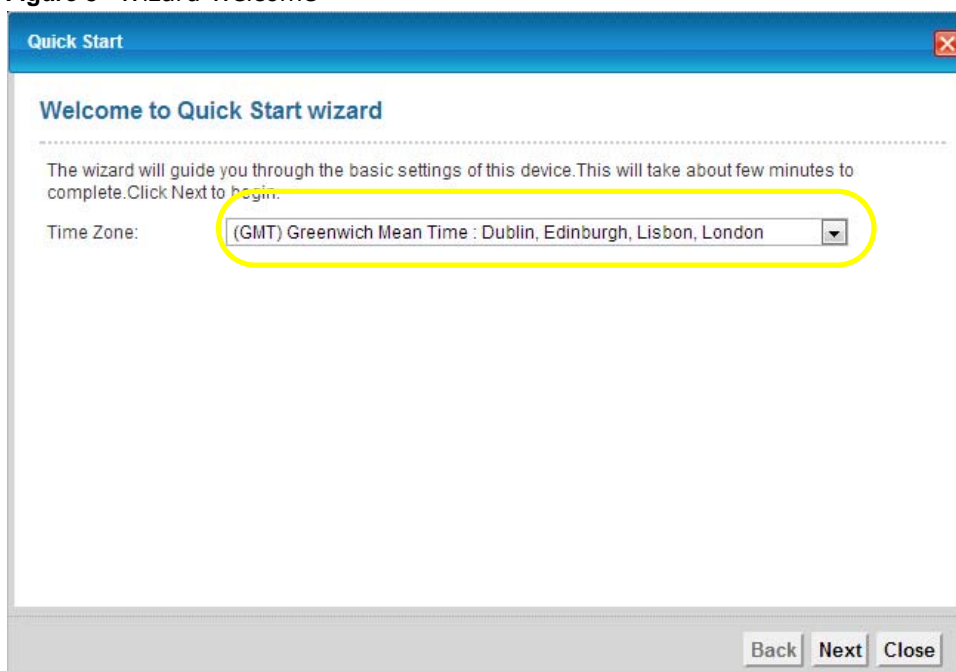
Figure 9 Internet Access Wizard Setup: IPoA Configuration

The screenshot shows a window titled "Quick Start" with a sub-header "Internet Configuration" and "STEP 1" in the top right. The configuration fields are as follows:

- Encapsulation: IPoA (dropdown)
- Multiplex: LLC (dropdown)
- VPI: 0 (text box, Range: 0~255)
- VCI: 33 (text box, Range: 32~65535)
- Note: The current connection type is set to IPoA.
- IP Address: 0.0.0.0 (text box)
- Default Gateway: 0.0.0.0 (text box)
- Primary DNS Server: 0.0.0.0 (text box)
- Secondary DNS Server: 0.0.0.0 (text box)

The following table describes the fields in this screen.

Table 3 Internet Access Wizard Setup: IPoA Configuration

LABEL	DESCRIPTION
Encapsulation	Select the encapsulation type your ISP uses from the Encapsulation drop-down list box: IPoA , ENET ENCAP , PPPoA , or PPPoE .
Multiplex	Select the multiplexing method used by your ISP from the Multiplex drop-down list box either VC-based or LLC-based.
VPI	Enter the Virtual Path Identifier (VPI) assigned to you. This field may already be configured.
VCI	Enter the Virtual Channel Identifier (VCI) assigned to you. This field may already be configured.
IP Address	Enter the IP address of the AMG1312-T Series.
Default Gateway	Enter the default gateway of the ZyXEL Device.
Primary DNS Server	Enter the primary DNS server IP address for the AMG1312-T Series.
Secondary DNS Server	Enter the secondary DNS server IP address for the AMG1312-T Series.
Back	Click this to return to the previous screen without saving.
Next	Click this to continue to the next wizard screen. The next wizard screen you see depends on what protocol you chose above.
Exit	Click this to close the wizard screen without saving.

Note: Virtual Path Identifier (VPI) and Virtual Channel Identifier (VCI) define a virtual circuit.

Figure 10 Internet Connection with ENET ENCAP

The following table describes the fields in this screen.

Table 4 Internet Connection with ENET ENCAP

LABEL	DESCRIPTION
Encapsulation	Select the encapsulation type your ISP uses from the Encapsulation drop-down list box: IPoA , ENET ENCAP , PPPoA , or PPPoE .
Multiplex	Select the multiplexing method used by your ISP from the Multiplex drop-down list box either VC-based or LLC-based.
VPI	Enter the Virtual Path Identifier (VPI) assigned to you. This field may already be configured.
VCI	Enter the Virtual Channel Identifier (VCI) assigned to you. This field may already be configured.
Select Yes to enter specific IP information from your Internet service provider. Enter your Internet access information exactly as your service provider gave it to you.	
IP Address	Enter the IP address of the AMG1312-T Series.
Subnet Mask	Enter the subnet mask in dotted decimal notation. Refer to the appendix to calculate a subnet mask if you are implementing subnetting.
Default Gateway	You must specify a gateway IP address (supplied by your ISP) when you use ENET ENCAP in the Encapsulation field in the previous screen.
Primary DNS Server	Enter the primary DNS server IP address for the AMG1312-T Series.
Secondary DNS Server	Enter the secondary DNS server IP address for the AMG1312-T Series.
Back	Click this to return to the previous screen without saving.
Apply	Click this to save your changes.
Exit	Click this to close the wizard screen without saving.

Figure 11 Internet Connection with PPPoA

Quick Start STEP 1

Internet Configuration

The current connection type is set to PPPoA and needs a user name and password to get online.

Encapsulation:

User Name:

Password:

Multiplex:

VPI: (Range : 0~255)

VCI: (Range : 32~65535)

IP Address:

Primary DNS Server:

Secondary DNS Server:

The following table describes the fields in this screen.

Table 5 Internet Connection with PPPoA

LABEL	DESCRIPTION
Encapsulation	Select the encapsulation type your ISP uses from the Encapsulation drop-down list box: IPoA , ENET ENCAP , PPPoA , or PPPoE .
User Name	Enter the login name that your ISP gives you.
Password	Enter the password associated with the user name above.
Multiplex	Select the multiplexing method used by your ISP from the Multiplex drop-down list box either VC-based or LLC-based.
VPI	Enter the Virtual Path Identifier (VPI) assigned to you. This field may already be configured.
VCI	Enter the Virtual Channel Identifier (VCI) assigned to you. This field may already be configured.
IP Address	Enter the IP address of the AMG1312-T Series.
Primary DNS Server	Enter the primary DNS server IP address for the AMG1312-T Series.
Secondary DNS Server	Enter the secondary DNS server IP address for the AMG1312-T Series.
Back	Click this to return to the previous screen without saving.
Apply	Click this to save your changes.
Exit	Click this to close the wizard screen without saving.

Figure 12 Internet Connection with PPPoE

The following table describes the fields in this screen.

Table 6 Internet Connection with PPPoE

LABEL	DESCRIPTION
User Name	Enter the user name exactly as your ISP assigned. If assigned a name in the form user@domain where domain identifies a service name, then enter both components exactly as given.
Password	Enter the password associated with the user name above.
Multiplex	Select the multiplexing method used by your ISP from the Multiplex drop-down list box either VC-based or LLC-based.
VPI	Enter the Virtual Path Identifier (VPI) assigned to you. This field may already be configured.
VCI	Enter the Virtual Channel Identifier (VCI) assigned to you. This field may already be configured.
Select Yes to enter specific IP information from your Internet service provider. Enter your Internet access information exactly as your service provider gave it to you.	
IP Address	Enter the IP address of the AMG1312-T Series.
Primary DNS Server	Enter the primary DNS server IP address for the AMG1312-T Series.
Secondary DNS Server	Enter the secondary DNS server IP address for the AMG1312-T Series.
Back	Click this to return to the previous screen without saving.
Apply	Click this to save your changes.
Exit	Click this to close the wizard screen without saving.

- If the user name and/or password you entered for PPPoE or PPPoA connection are not correct, you are prompted to enter the correct information.
- If the Internet connection fails, check to see if your account is activated.

After you configure the Internet access information, use the following screen to set up your wireless LAN.

- 5 Check the **Wireless Service** box to enable wireless connection on the ZyXEL device.
- 6 Configure your wireless settings in this screen. Click **Next**.

Figure 13 Wireless Setup

The screenshot shows a window titled "Quick Start" with a sub-header "Wireless Setup" and "STEP 2" in the top right. Below the header, a message states: "The following settings are the current wireless settings which your wireless client devices need in order to get connected to this device." The configuration fields are as follows:

- Wireless Service:** A checked checkbox.
- Wireless Network Name (SSID):** A text input field containing "ZyXEL_9ABC".
- Channel Selection:** A dropdown menu showing "Channel 6".
- Security Level:** A text input field containing "WPAPSKWPA2PSK".
- Pre-Shared Key:** A text input field containing "G*3Fv\$3<". To the right of the field is a note: "(Enter 8-63 characters or 64 hexadecimal digits (a-f, A-F, and 0-9).)".

The following table describes the labels in this screen.

Table 7 Wireless Setup

LABEL	DESCRIPTION
Wireless Service	Click this to enable or disable wireless service on the ZyXEL device.
Wireless Network Name(SSID)	Enter a descriptive name (up to 32 printable 7-bit ASCII characters) for the wireless LAN. If you change this field on the AMG1312-T Series, make sure all wireless stations use the same SSID in order to access the network.
Channel Selection	The range of radio frequencies used by IEEE 802.11b/g wireless devices is called a channel. Select a channel ID that is not already in use by a neighboring device.
Security	Displays the security setting. To modify, see Section 7.2 on page 88 .
Pre-Shared Key	Enter a set of characters (8 to 63 characters or 64 hexadecimal digits [a-f, A-F, and 0-9]) for the shared security key.
Back	Click this to return to the previous screen without saving.
Next	Click this to continue to the next wizard screen.
Exit	Click this to close the wizard screen without saving.

Note: The wireless stations and AMG1312-T Series must use the same SSID and channel ID for wireless communication.

- 7 The configuration settings are saved and applied. Click **Close** to complete the Internet / Wireless setup.

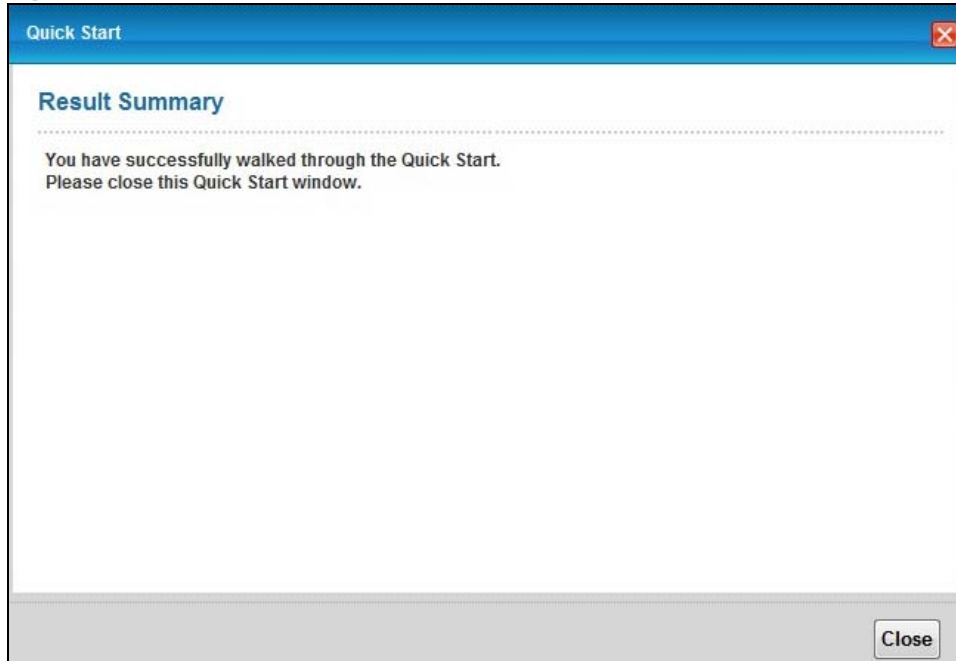
Figure 14 Results Summary

- 8 Launch your web browser and navigate to www.zyxel.com. Internet access is just the beginning. Refer to the rest of this guide for more detailed information on the complete range of AMG1312-T Series features. If you cannot access the Internet, open the web configurator again to confirm that the Internet settings you configured in the wizard setup are correct.

4.1 Overview

This chapter shows you how to use the AMG1312-T Series's various features.

- [Setting Up Your DSL Connection](#), see page 34
- [IPv6 Address Configuration](#), see page 36
- [Setting Up a Secure Wireless Network](#), see page 37
- [Configuring the MAC Address Filter for Restricting Wireless Internet Access](#), see page 44
- [Setting Up NAT Forwarding for a Game Server](#), see page 45
- [Setting Up NAT Forwarding for a Game Server](#), see page 45
- [Configuring Firewall Rules to Allow a Specified Service](#), see page 47
- [Configuring Static Route for Routing to Another Network](#), see page 50
- [Port Binding Configuration](#), see page 52
- [Configuring QoS to Prioritize Traffic](#), see page 56
- [Access the AMG1312-T Series from the Internet Using DDNS](#), see page 59

4.2 Setting Up Your DSL Connection

This tutorial shows you how to set up your Internet connection using the web configurator.

If you connect to the Internet through a DSL connection, use the information from your Internet Service Provider (ISP) to configure the AMG1312-T Series. Do the following steps:

- 1 Connect the AMG1312-T Series properly. Refer to the Quick Start Guide for details on the AMG1312-T Series's hardware connection.
- 2 Connect one end of a DSL cable to the DSL port of your AMG1312-T Series. The other end should be connected to the DSL port in your house or a DSL router/modem provided by your ISP.
- 3 Connect one end of Ethernet cable to an Ethernet port on the AMG1312-T Series and the other end to a computer that you will use to access the web configuration.
- 4 Connect the AMG1312-T Series to a power source, turn it on and wait for the **POWER** LED to become a steady green.

Account Configuration

For this example, the interface type is ADSL and the connection has the following information.

General	
Mode	Router
Encapsulation	PPPoE
User Name	1234@DSL-Ex.com
Password	ABCDEF!
Service Name	My DSL
Multiplex	LLC
IPv6/IPv4 Dual Stack	Enabled
PPP Authentication	Auto
VPI	0
VCI	33
Others	IP Address: Obtain IP Address Automatically DNS Server: Obtained From ISP IPv6 Address: Obtain IPv6 Address Automatically DHCP IPv6: DHCP DHCP PD: Enable WAN Identifier Type: EUI64

Go to **Network Setting > Broadband**, enter or select these values and click **Apply**.

The screenshot shows the following configuration details:

- Line:** Type: Auto Sync-Up
- General:** Mode: Router; Encapsulation: PPPoE; User Name: ChangeMe; Password: [masked]; Service Name: [empty]; Multiplex: LLC; IPv6/IPv4 Dual Stack: IPv4/IPv6; PPP Authentication: Auto; Virtual Circuit ID: VPI: 0 (Range: 0~255), VCI: 33 (Range: 32~65535)
- IP Address:** Obtain an IP Address Automatically (selected); Static IP Address: IP Address: 0.0.0.0
- Routing Feature:** Apply as Default Gateway (checked)
- DNS Server:** Primary DNS: Obtained From ISP (0.0.0.0); Secondary DNS: Obtained From ISP (0.0.0.0)
- IPv6 Address:** Obtain an IP Address Automatically (selected); DHCP IPv6: DHCP (selected), SLAAC, Auto; DHCP PD: Enable (selected), Disable; WAN Identifier Type: Manual, EUI64 (selected); WAN Identifier: [empty]
- Bridge and Routing mode in the same WAN:** Enable Con-current WAN (unchecked)
- Connection:** Keep Alive (selected), Connect on Demand; Max Idle Time: 0 Sec

Buttons at the bottom right: Apply, Cancel, Advanced Setup

This completes your DSL WAN connection setting.

4.3 IPv6 Address Configuration

If the ISP's network supports IPv6, the ISP may assign an IPv6 address to the AMG1312-T Series automatically.



In the **Network Setting > Broadband** screen's **IPv6 Address** configuration section, select **Obtain an IP Address Automatically**. In the **DHCP IPv6** field select **DHCP** to obtain an IPv6 address from a DHCPv6 server. In the **DHCP PD** field select **Enable** to have the AMG1312-T Series pass the WAN prefix to LAN hosts. The LAN hosts can then use the prefix to generate their IPv6 addresses.

IPv6 Address

Obtain an IP Address Automatically

Static IP Address

DHCP IPv6 DHCP SLAAC Auto

DHCP PD Enable Disable

WAN Identifier Type Manual EUI64

WAN Identifier

4.4 Setting Up a Secure Wireless Network

Thomas wants to set up a wireless network so that he can use his notebook to access the Internet. In this wireless network, the AMG1312-T Series serves as an access point (AP), and the notebook is the wireless client. The wireless client can access the Internet through the AP.



Thomas has to configure the wireless network settings on the AMG1312-T Series. Then he can set up a wireless network using WPS ([Section 4.4.2 on page 38](#)) or manual configuration ([Section 4.4.3 on page 42](#)).

4.4.1 Configuring the Wireless Network Settings

This example uses the following parameters to set up a wireless network. In the client, choose the AP with the SSID configured here. When prompted for a key, use the Pre-Shared Key configured here.

SSID	SecureWirelessNetwork
Security Mode	WPA2-PSK
Pre-Shared Key	DoNotStealMyWirelessNetwork
802.11 Mode	802.11b+g+n

- 1 Click **Network Setting > Wireless** to open the **General** screen. Configure the screen using the provided parameters (see [page 37](#)). Click **Apply**.

Wireless Network Setup

Wireless Enable Wireless LAN

Wireless Network Settings

Wireless Network Name(SSID): ZyXEL_7DC8

Hide SSID

Client Isolation

MBSSID/LAN Isolation

Channel Selection : Channel 6

Operating Channel 6

Security Level

No Security Basic **More Secure (Recommended)**

Security Mode : WPA2-PSK

Enter 8-63 characters or 64 hexadecimal digits (a-f, A-F, and 0-9).

Pre-Shared Key 4Wx4WU9EHER3E [more...](#)

- 2 Click **Network Setting > Wireless > Advanced** and make sure **802.11b+g+n** is selected in the **802.11 Mode** field. Click **Apply**.

Fragmentation Threshold: 2346 (256 ~ 2346, even numbers only)

Output Power : 100%

Preamble : Long

802.11 Mode : 802.11b+g+n

Channel Width : Auto

Thomas can now use the WPS feature to establish a wireless connection between his notebook and the AMG1312-T Series (see [Section 4.4.2 on page 38](#)). He can also use the notebook's wireless client to search for the AMG1312-T Series (see [Section 4.4.3 on page 42](#)).

4.4.2 Using WPS

This section shows you how to set up a wireless network using WPS. WPS is a way to automatically set up a secure wireless network connection between an AP and a notebook. Limitations of using WPS are that it must be done two devices at a time and within two minutes. It uses the AMG1312-T Series as the AP and ZyXEL NWD210N as the wireless client which connects to the notebook.

Note: The wireless client must be a WPS-aware device (for example, a WPS USB adapter or PCMCIA card).

There are two WPS methods to set up the wireless client settings:

- **Push Button Configuration (PBC)** - simply press a button. This is the easier of the two methods.
- **PIN Configuration** - configure a Personal Identification Number (PIN) on the AMG1312-T Series. A wireless client must also use the same PIN in order to download the wireless network settings from the AMG1312-T Series.

Push Button Configuration (PBC)

- 1 Make sure that your AMG1312-T Series is turned on and your notebook is within the cover range of the wireless signal.
- 2 Make sure that you have installed the wireless client driver and utility in your notebook.
- 3 Make sure wireless LAN is enabled and the wireless security mode is set to **WPA-PSK2** or **No Security** in the **Network Setting > Wireless > General** screen.
- 4 In the wireless client utility, go to the WPS setting page. Enable WPS and press the WPS button (**Start** or **WPS** button).
- 5 Push and hold the **WPS** button on the AMG1312-T Series for 1-2 seconds. Alternatively, you may log into AMG1312-T Series's web configuration, enable WPS and click the **WPS** button in the **Network Setting > Wireless > WPS** screen.

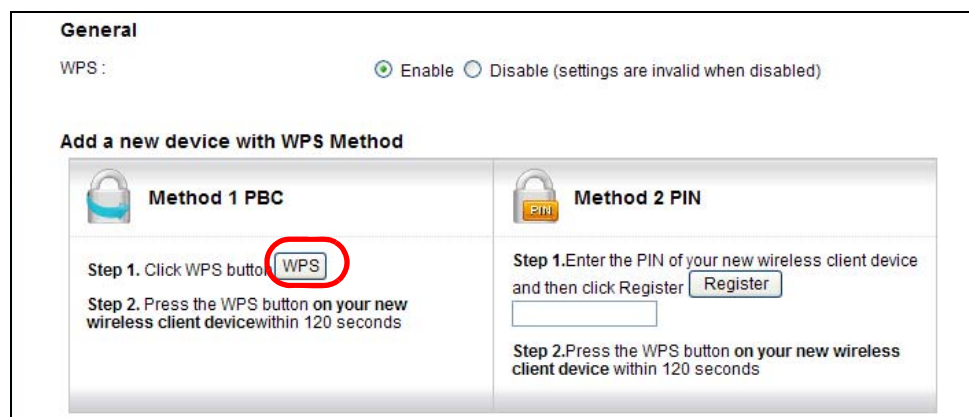

Note: It doesn't matter which button (on the client or the AMG1312-T Series) is pressed first. You must press the second button within two minutes of pressing the first one.

The AMG1312-T Series sends the proper configuration settings to the wireless client. This may take up to two minutes. The wireless client is then able to communicate with the AMG1312-T Series securely.

The following figure shows you an example of how to set up a wireless network and its security by pressing a button on both AMG1312-T Series and wireless client.

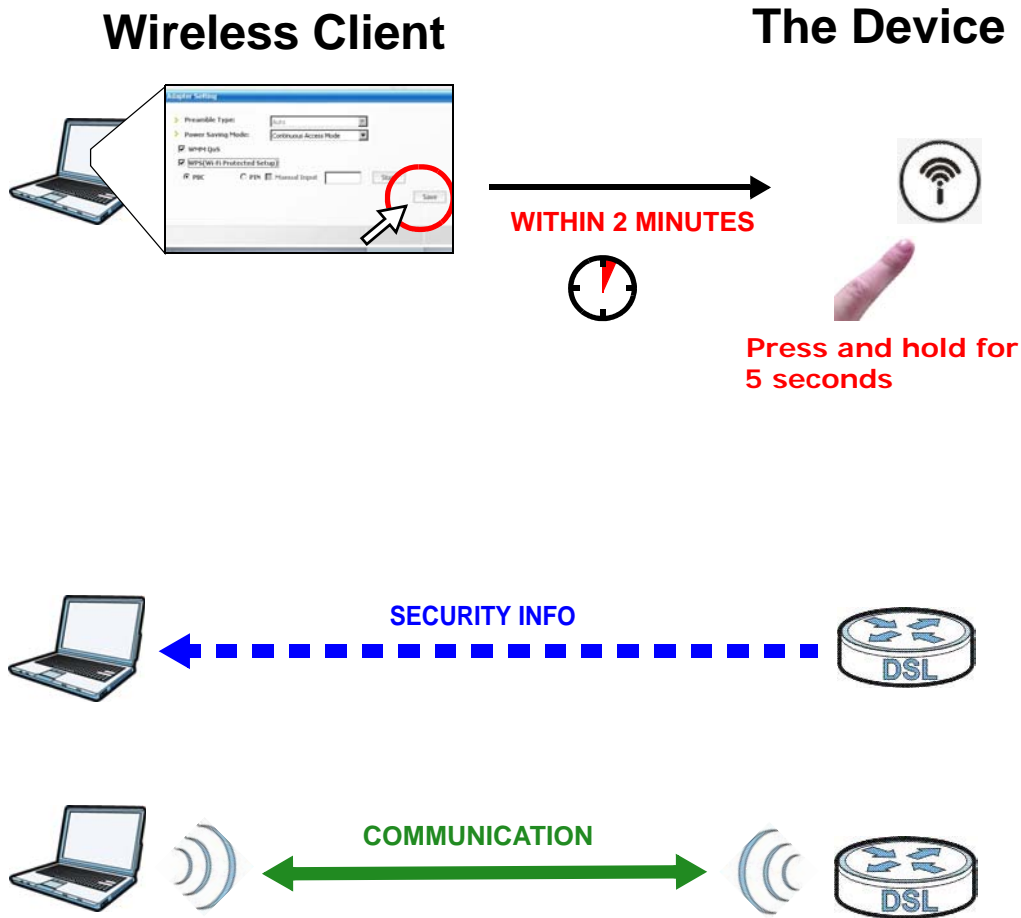

PIN Configuration



When you use the PIN configuration method, you need to use both the AMG1312-T Series's web configuration utility and the wireless client's utility.

- 1 Launch your wireless client's configuration utility. Go to the WPS settings and select the PIN method to get a PIN number.
- 2 Enter the PIN number in the **PIN** section in the **Network Setting > Wireless > WPS** screen on the AMG1312-T Series.

General

WPS : Enable Disable (settings are invalid when disabled)

Add a new device with WPS Method

 Method 1 PBC	 Method 2 PIN
<p>Step 1. Click WPS button <input type="button" value="WPS"/></p> <p>Step 2. Press the WPS button on your new wireless client device within 120 seconds</p>	<p>Step 1. Enter the PIN on your new wireless client device and then click Register <input type="button" value="Register"/></p> <p><input type="text"/></p> <p>Step 2. Press the WPS button on your new wireless client device within 120 seconds</p>

- 3 Click the **Start** and **Register** buttons (or the button next to the PIN field) on both the wireless client utility screen and the AMG1312-T Series's **WPS** screen within two minutes.

The AMG1312-T Series authenticates the wireless client and sends the proper configuration settings to the wireless client. This may take up to two minutes. The wireless client is then able to communicate with the AMG1312-T Series securely.

The following figure shows you how to set up a wireless network and its security on a AMG1312-T Series and a wireless client by using PIN method.

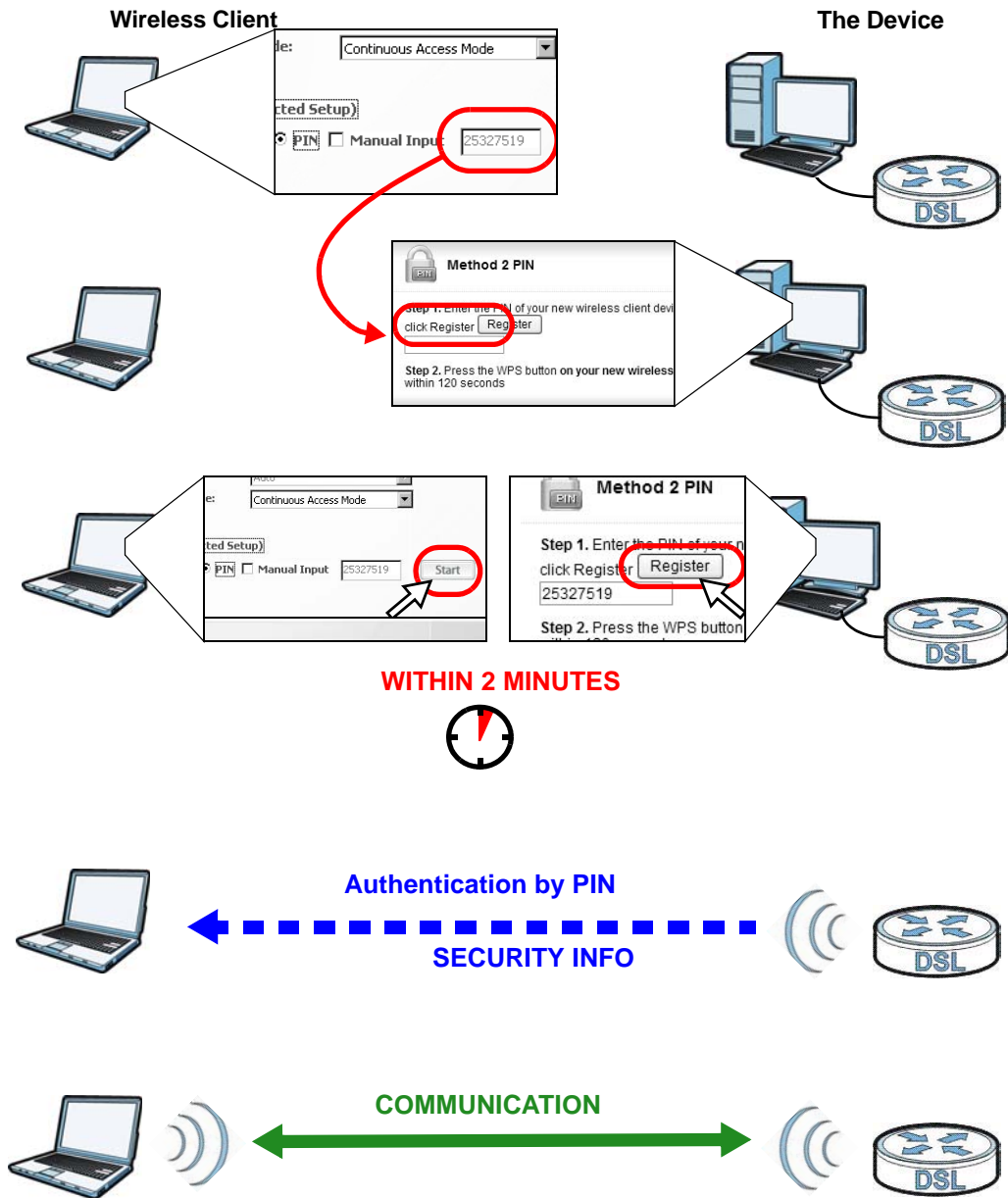

4.4.3 Connecting Wirelessly to your AMG1312-T Series

This section describes how to connect wirelessly to your AMG1312-T Series. The connection procedure is shown here using Windows XP as an example.

- 1 Right-click the wireless adapter icon which appears in the bottom right of your computer monitor. Click **View Available Wireless Networks**.



- 2 Select the AMG1312-T Series's **SSID** name and click **Connect** (A). The SSID "SecureWirelessNetwork" is given here as an example.

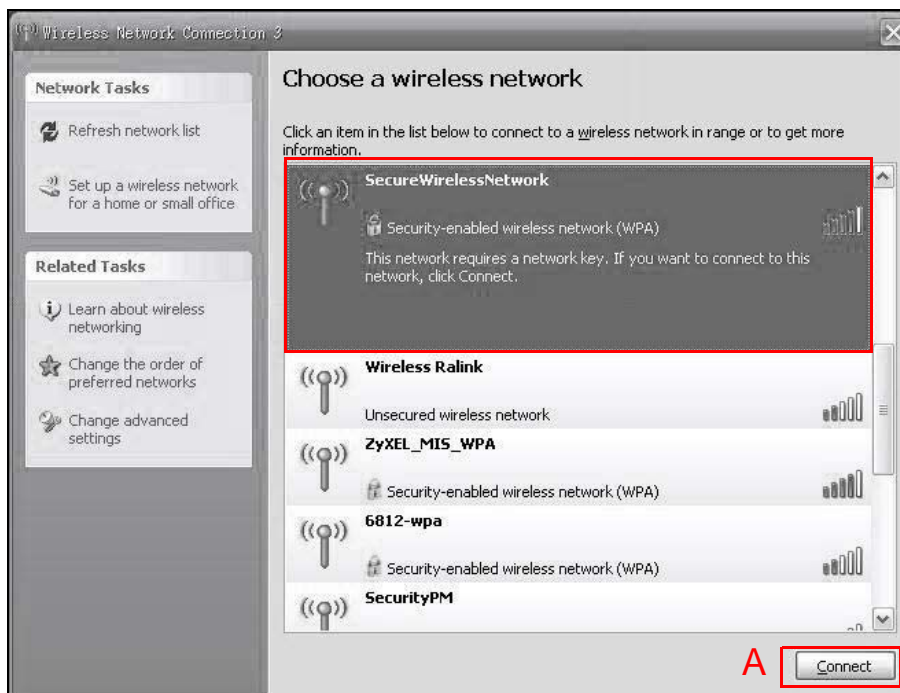

- 3 You are prompted to enter a password. Enter it and click **Connect**.



- 4 You may have to wait several minutes while your computer connects to the wireless network.
- 5 You should now be securely connected wirelessly to the AMG1312-T Series.



Congratulations! Your computer is now ready to connect to the Internet wirelessly through your AMG1312-T Series.

Note: If you cannot connect wirelessly to the AMG1312-T Series, check you have selected the correct SSID and entered the correct security key. If that does not work, ensure your wireless network adapter is enabled by clicking on the wireless adapter icon and clicking Enable.

4.5 Configuring the MAC Address Filter for Restricting Wireless Internet Access

Thomas noticed that his daughter Josephine spends too much time surfing the web and downloading media files. He decided to prevent Josephine from accessing the Internet so that she can concentrate on preparing for her final exams.

Josephine's computer connects wirelessly to the Internet through the AMG1312-T Series. Thomas can deny access to the wireless network using the MAC address of Josephine's computer.

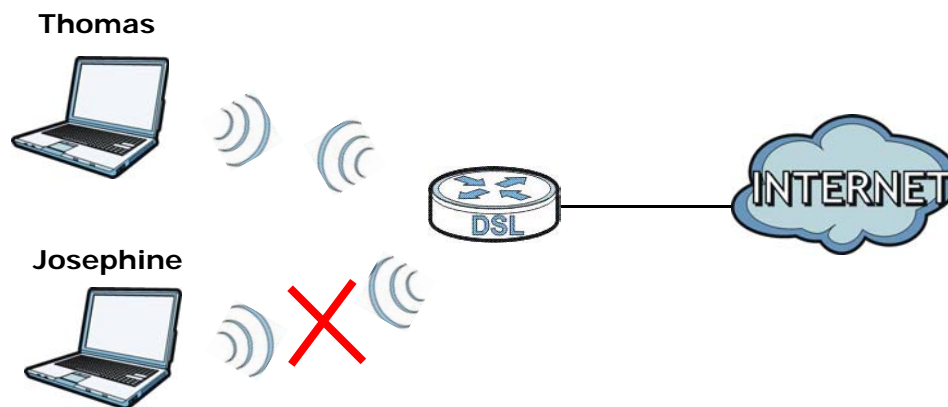

- 1 Check the MAC address (physical address) of the wireless card on Josephine's computer using the "ipconfig /all" command in a Command Prompt.

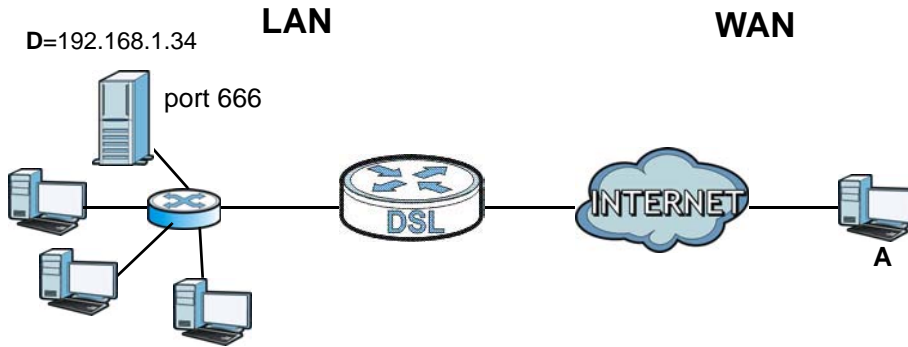

4.6.1 Port Forwarding

Thomas needs to configure the port settings and IP address on the AMG1312-T Series. Traffic should be forwarded to port 666 of the Doom server computer which has an IP address of 192.168.1.34.

Thomas may set up the port settings by configuring the port settings for the Doom server computer (see [Section 11.3 on page 149](#) for more information).

- 1 Activate NAT in the **Network Setting > NAT > General** screen. Click **Apply**.

Active

Max NAT/Firewall Session Per User

Note:

Maximum number of NAT/firewall sessions for the router is 8192. To remove the per user limit, set to 8192.

Apply Cancel

- 2 Click **Network Setting > NAT > Port Forwarding**. Select **PVC0** as the WAN interface and click **Add new rule**.

WAN Interface

Add new rule

#	Active	Service Name	External Start Port	External End Port	Internal Start Port	Internal End Port	Server IP Address	Modify
---	--------	--------------	---------------------	-------------------	---------------------	-------------------	-------------------	--------

Note:

The TCP port 7547 is reserved for TR069 connection request port.

- 3 Configure the screen with the following values:

Service Name	Select User Define .
Start/End Ports	Enter 666 as the Start and End port.
Server IP Address	Enter the IP address of the Doom server (192.168.1.34 for this example).

The screen should look as follows. Click **Apply**.

- The port forwarding settings you configured appear in the table. The AMG1312-T Series forwards port 666 traffic to the computer with IP address 192.168.1.34.

#	Active	Service Name	External Start Port	External End Port	Internal Start Port	Internal End Port	Server IP Address	Modify
1		User Define	666	666	666	666	192.168.1.34	

Note :
The TCP port 7547 is reserved for TR069 connection request port.

Players on the Internet then can have access to Thomas' Doom server.

4.7 Configuring Firewall Rules to Allow a Specified Service

By default the firewall will block traffic originating from the WAN (1). However, if you are running a server or other service, you may need to allow access from the WAN (2). The following tutorial will show how to allow traffic from WAN to LAN if it matches a specified port number.

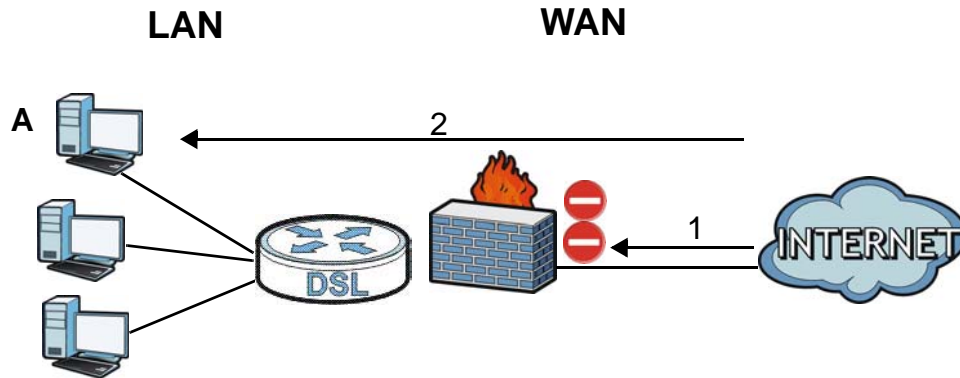

- 1 Click **Security > Firewall** and select **Custom**. Click **Apply** to save your settings.

Firewall

High
This setting blocks all traffic to and from the Internet. Only local network traffic and LAN to WAN service (Telnet, FTP, HTTP, HTTPS, DNS, POP3, SMTP) is permitted.

Medium
This is the recommended setting. It allows traffic to the Internet but blocks anyone from the Internet from accessing any services on your local network.

Low
This setting allows traffic to the Internet and also allows someone from the Internet to access services on your local network. This would be used with Port Forwarding, Default Server.

Custom
This setting allows the customer to create and edit individual firewall rules.

Off
This setting is not recommended. It disables firewall protection for your network and could potentially expose your network to significant security risks. This option should only be used for troubleshooting or if you intend using another firewall in conjunction with your ZyXEL router.

- 2 Click the **Rules** tab. In the **Packet Direction** field select **WAN to LAN** and click **Add**.

Rules

Firewall Rules Storage Space in Use (0%)

0% 100%

Packet Direction WAN to LAN

Create a new rule after rule number 0

#	Active	Source IP Address	Destination IP Address	Service	Action	Source Interface	Destination Interface	Modify	Order

- 3 The **Add New Firewall Rule** screen will appear. Click the **Edit Customized Services** button to access the following screen. Click **Add** and configure the following settings. In this tutorial, a hypothetical port 123 is allowed. Click **OK**.

Service Name	My_Service
Service Type	TCP
Port Number	123

Config

Service Name

Service Type

Port Configuration

Type Single Port Range

Port Number From To

- 4 In the **Add New Firewall Rule** screen, select **Active**. In the **Available Services** field, select the service you configured, **My_Service**. Click **OK**.

Add New Firewall Rule

Edit Rule

Active

Action for Matched Packets

IP Version Type

Rate Limit packets/second

Maximum Burst Number (packets)

Log(Log Level:DEBUG)

Rules

Source Address

Address Type

Start IP Address

End IP Address

Subnet Mask

Source Mac Address

Source Interface

Destination Address

Address Type

Start IP Address

End IP Address

Subnet Address

Destination Interface

Service

Available Services

TCP Flag (SYN,ACK,FIN,RST,URG,PSH,ALL,NONE)

Schedule

Day to Apply

Everyday

Sun Mon Tue Wed Thu Fri Sat

Time of Day to Apply:(24-Hour Format)

All Day

Start hour minute End hour minute

- 5 The firewall rule you configured appears in the table. The AMG1312-T Series allows traffic from the WAN to LAN if it matches port 123.

Rules
Firewall Rules Storage Space in Use (2%)
0% 100%

Packet Direction: WAN to LAN ▼

Create a new rule after rule number: 0 Add

#	Active	Source IP Address	Destination IP Address	Service	Action	Source Interface	Destination Interface	Modify	Order
1	Yes	Any	Any	My_Ser...	Permit		N/A	  	▶◀

4.8 Configuring Static Route for Routing to Another Network

In order to extend your Intranet and control traffic flowing directions, you may connect a router to the AMG1312-T Series's LAN. The router may be used to separate two department networks. This tutorial shows how to configure a static routing rule for two network routings.

In the following figure, router **R** is connected to the AMG1312-T Series's LAN. **R** connects to two networks, **N1** (192.168.1.x/24) and **N2** (192.168.10.x/24). If you want to send traffic from computer **A** (in **N1** network) to computer **B** (in **N2** network), the traffic is sent to the AMG1312-T Series's WAN default gateway by default. In this case, **B** will never receive the traffic.

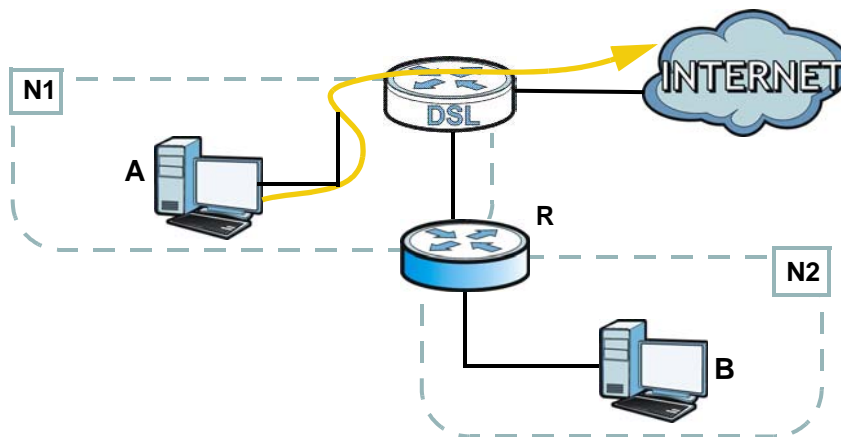

You need to specify a static routing rule on the AMG1312-T Series to specify **R** as the router in charge of forwarding traffic to **N2**. In this case, the AMG1312-T Series routes traffic from **A** to **R** and then **R** routes the traffic to **B**.

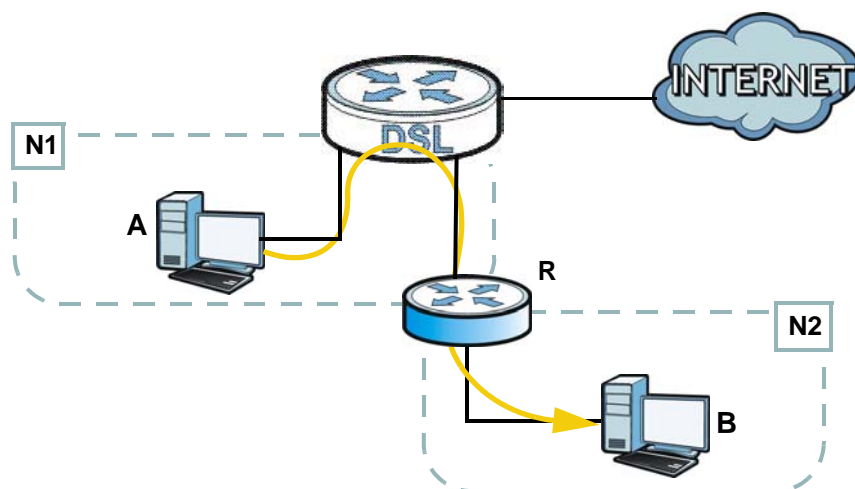

This tutorial uses the following example IP settings:

Table 8 IP Settings in this Tutorial

DEVICE / COMPUTER	IP ADDRESS
The AMG1312-T Series's WAN	172.16.1.1
The AMG1312-T Series's LAN	192.168.1.1
A	192.168.1.34
R's N1	192.168.1.253
R's N2	192.168.10.2
B	192.168.10.33

To configure a static route to route traffic from **N1** to **N2**:

- 1 Log into the AMG1312-T Series's Web Configurator.
- 2 Click **Network Setting > Static Route**.
- 3 Click **Edit** on a new rule in the **Static Route** screen.



- 4 Configure the **Static Route Setup** screen using the following settings:
 - 4a Type **192.168.10.0** and subnet mask **255.255.255.0** for the destination, **N2**.
 - 4b Type **192.168.1.253** (R's N1 address) in the **Gateway IP Address** field.
 - 4c Enter **1** in the **Metric** field.

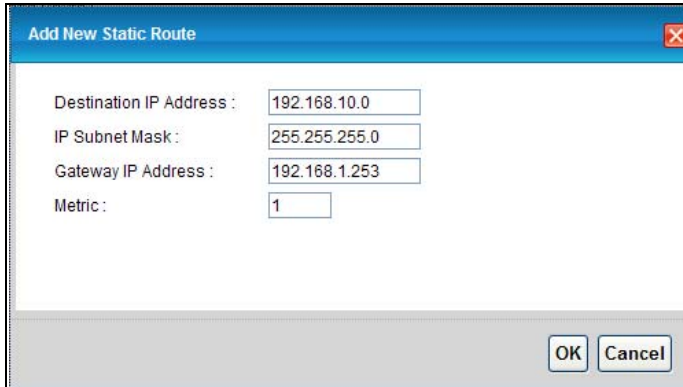

The screenshot shows a dialog box titled "Add New Static Route". It contains the following fields and values:

Field	Value
Destination IP Address :	192.168.10.0
IP Subnet Mask :	255.255.255.0
Gateway IP Address :	192.168.1.253
Metric :	1

Buttons: OK, Cancel

4d Click **OK**.

Now **B** should be able to receive traffic from **A**. You may need to additionally configure **B**'s firewall settings to allow specific traffic to pass through.

4.9 Port Binding Configuration

This tutorial shows you how to configure port binding for WAN connections with different ATM QoS settings for different types of traffic. The port binding feature is used to group each WAN connection with specific LAN ports and WLANs. In this example ATM QoS settings are configured for a WAN PVC for time sensitive Media-On-Demand (MOD) traffic. ATM QoS settings are also configured for another WAN PVC for non-time sensitive data traffic.

4.9.1 Configuring ATM QoS for Multiple WAN Connections

This example shows an application for multiple WAN connections with different ATM QoS Settings.

More than one WAN connection on the AMG1312-T Series may be configured to record traffic statistics or calculate service charges.

Three WAN connections are configured over the ADSL line:

- The connection with VPI/VCI, **0/33**, is dedicated for general data transmission.
- The connection with VPI/VCI, **0/34**, is dedicated for VoIP service.
- The connection with VPI/VCI, **0/35**, is dedicated for Media-On-Demand (MOD) service.

To configure bandwidth for the WAN connections, access the WAN configuration **Advanced Setup** screen by clicking **Network Setting** > **Broadband**. Click **Advanced Setup**.

Line
ADSL Mode Auto Sync-Up ▾

General

Mode Router ▾

Encapsulation PPPoE ▾

User Name ChangeMe

Password ••••••

Service Name

Multiplex LLC ▾

IPv6/IPv4 Dual Stack: IPv4/IPv6 ▾

PPP Authentication Auto ▾

Virtual Circuit ID

VPI 0 (Range : 0~255)

VCI 33 (Range : 32~65535)

IP Address

Obtain an IP Address Automatically

Static IP Address

IP Address 0.0.0.0

DNS Server

Primary DNS Obtained From ISP ▾ 0.0.0.0

Secondary DNS Obtained From ISP ▾ 0.0.0.0

IPv6 Address

Obtain an IP Address Automatically

Static IP Address

DHCP IPv6 DHCP SLAAC Auto

DHCP PD Enable Disable

WAN Identifier Type Manual EUI64

WAN Identifier

Connection

Keep Alive

Connect on Demand Max Idle Time 0 Sec

EXAMPLE

To configure bandwidth for the data connection, select **UBR with PCR** in the **ATM QoS Type** field. Click **Apply**.

RIP & Multicast Setup	
RIP Direction	None
RIP Version	RIP1
Multicast	None
MLD Proxy	None
ATM QoS	
ATM QoS Type	UBR With PCR
Peak Cell Rate	0 cell/sec
Sustain Cell Rate	0 cell/sec
Maximum Burst Size	0 cell
PPPoE Passthrough	No
MTU	
MTU	1492
<input type="button" value="Apply"/> <input type="button" value="Cancel"/> <input type="button" value="Advanced Setup"/>	

To configure dedicated bandwidth of 400 kbps for the VoIP connection, select **CBR** in the **ATM QoS Type** field and enter the **Peak Cell Rate** as **943** (divide the bandwidth 400000 bps by 424). Click **Apply** to save the settings.

RIP & Multicast Setup	
RIP Direction	None
RIP Version	RIP1
Multicast	None
MLD Proxy	None
ATM QoS	
ATM QoS Type	CBR
Peak Cell Rate	943 cell/sec
Sustain Cell Rate	0 cell/sec
Maximum Burst Size	0 cell
PPPoE Passthrough	No
MTU	
MTU	1492
<input type="button" value="Apply"/> <input type="button" value="Cancel"/> <input type="button" value="Advanced Setup"/>	

To configure variable bandwidth of 2 Mbps for MOD data connection, select **Realtime VBR** in the **ATM QoS Type** field. Set the **Peak Cell Rate** as **4717** (divide the bandwidth 2mbps by 424) and set both the **Sustain Cell Rate** and **Maximum Burst Size** as **4716** (which is less than the peak cell rate). Click **Apply** to save the settings.

RIP & Multicast Setup

RIP Direction: None

RIP Version: RIP1

Multicast: None

MLD Proxy: None

ATM QoS

ATM QoS Type: Realtime VBR

Peak Cell Rate: 4717 cell/sec

Sustain Cell Rate: 4716 cell/sec

Maximum Burst Size: 4716 cell

PPPoE Passthrough: No

MTU

MTU: 1492

Apply Cancel Advanced Setup

Configured WAN connections can be viewed by clicking the **More Connections** tab under **Network Setting > Broadband**. See the WAN Setup chapter ([Chapter 6 on page 68](#)) for more information on configuring WAN connections and ATM QoS settings.

4.9.2 Configuring Port Binding

You can then group specific WAN PVCs with LAN ports or WLANs, so traffic from these ports is forwarded through specific WAN PVCs. In the configuration shown below, the WAN connections set up in the previous section are bound as follows:

Table 9 Port Binding Groups

GROUP INDEX	WAN CONNECTION	LAN PORT
0	PVC0 - for Data	eth1, eth2, APO
1	PVC1 - for VoIP	eth3
2	PVC2 - for MOD	eth4

- 1 Access the port binding screen by clicking **Network Setting > Port Binding**, and select **Activated Port Binding** to turn on the port binding feature.
- 2 Click the **Port Binding** tab, specify the **Group Index** and select the ports to include in the port binding group. Click **Apply**.

Enable Port Binding Disable

Port Binding

Active Activated Deactivated

Group Index: 0

ATM VCs

Ethernet

Wireless LAN

Group Summary

Group Summary

Port Binding Summary

EXAMPLE

Group ID	Group Port
Group0	PVC1,eth2,AP0,
Group1	PVC0,eth1,

- 3 The configured groups can be viewed by clicking the Port Binding Summary button. See the Port Binding chapter ([Chapter 12 on page 157](#)) for more details on configuring port binding.

4.10 Configuring QoS to Prioritize Traffic

This section contains tutorials on how you can configure the QoS screen.

Let's say you are a team leader of a small sales branch office. You want to prioritize e-mail traffic because your task includes sending urgent updates to clients at least twice every hour. You also upload data files (such as logs and e-mail archives) to the FTP server throughout the day. Your colleagues use the Internet for research, as well as chat applications for communicating with other branch offices.

In the following figure you want to configure QoS so that e-mail traffic gets the highest priority. You can do the following:

- Configure a queue to assign the highest priority queue (1) to e-mail traffic from the LAN interface, so that e-mail traffic would not get delayed when there is network congestion.
- Note the MAC address (AA:FF:AA:FF:AA:FF for example) of your computer and map it to queue 1.

Note: QoS is applied to traffic flowing out of the AMG1312-T Series.

Traffic that does not match this class is assigned a priority queue based on the internal QoS mapping table on the AMG1312-T Series.

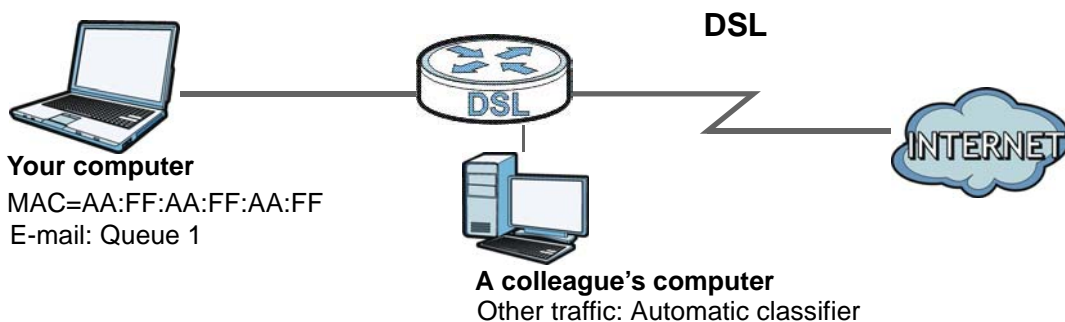

- 1 Click **Network Setting > QoS** and check **Active QoS**. Click **Apply**.

Active QoS

Traffic priority will be automatically assigned by None

- 2 Go to **Network Setting > QoS > Queue Setup**. Click the **Edit** icon next to an entry to configure a queue.

Inde	Status	Name	Interface	Priority	Weight	Rate Limit	Modify
1		N/A	N/A	N/A	N/A	N/A N/A	
2		N/A	N/A	N/A	N/A	N/A N/A	
3		N/A	N/A	N/A	N/A	N/A N/A	
4		N/A	N/A	N/A	N/A	N/A N/A	

Note :
If queue is deleted, then related classifiers will be removed too.

- 3 Select **Active** and give it a name (**Queue1** in this example). Select **WAN** in the **Interface** field and **1** in the **Priority** and **Weight** fields. Then click **OK**.

Queue Edit

Active :

Name :

Interface : WAN

Priority : 1(Highest)

Weight : 1

Rate Limit : kbps

- 4 Go to **Network Setting > QoS > Class Setup** and click **Add new Classifier**.

Index	Status	From Interface	Classification Criteria	DSCP(Traffic Class) Mark	802.1P/1Q Mark	To Queue	Modify
-------	--------	----------------	-------------------------	--------------------------	----------------	----------	--------

- 5 Select **Active** and follow the settings as shown in the screen below. Then click **OK**. Note that you have to select **TCP** in the **IP Protocol** field first, then you can configure the source port range setting.

✖
Add new Classifier

Rule Index ▼

Class Configuration

Active

Ether Type IPv4 (0x0800) ▼

Interface From LAN ▼

To Queue ▼

Criteria Configuration

Use the configurations below to specify the characteristics of a data flow need to be managed by this QoS rule

- **Basic**
- From Interface
 LAN1 LAN2 LAN3 LAN4 ra0 ra1 ra2 ra3
- **Source**
- IP Address IP Subnet Mask Exclude
- Port Range ~ Exclude
- MAC Address MAC Mask Exclude
- **Destination**
- IP Address IP Subnet Mask Exclude
- Port Range ~ Exclude
- MAC Address MAC Mask Exclude
- **Others**
- Service ▼
- IP Protocol ▼
- TCP ACK Exclude
- DHCP Exclude
- Packet Length ~ Exclude
- IPP/DS Field
 IPP/TOS DSCP
 Exclude
- IP Precedence Range ~ Exclude
- Type of Service Exclude
- DSCP Range(0 ~ 63) ~ Exclude
- 802.1P ~ Exclude
- VLAN ID ~ (Value Range: 1 ~ 4094) Exclude

Action

Forward to Unchange ▼

IPP/DS Field
 IPP/TOS DSCP

IP Precedence Mark Unchange ▼

Type Of Service Mark Unchange ▼

DSCP Mark(0 ~ 63) Unchange ▼

802.1Q Tag Same ▼

- Ethernet Priority ▼

- VLAN ID (Value Range: 1 ~ 4094)

OK
Cancel

Interface	Select From LAN .
To Queue	Link this to a queue created in the Network Setting > QoS > Queue Setup screen, which is the 1 queue created in this example.
Source MAC Address	Type the MAC address of your computer - AA:FF:AA:FF:AA:FF . Type the Source Mac Netmask if you know it.
Source Port Range	Enter the port number to which the rule should be applied - 25 for SMTP.
Protocol ID	Select the IP protocol type - TCP .

This maps e-mail traffic to queue 1 created in the previous screen (see the **Source Port Range** field). This also maps your computer's MAC address to queue 1 (see the **Source MAC Address** field).

4.11 Access the AMG1312-T Series from the Internet Using DDNS

If you connect your AMG1312-T Series to the Internet and it uses a dynamic WAN IP address, it is inconvenient for you to manage the device from the Internet. The AMG1312-T Series's WAN IP address changes dynamically. Dynamic DNS (DDNS) allows you to access the AMG1312-T Series using a domain name.

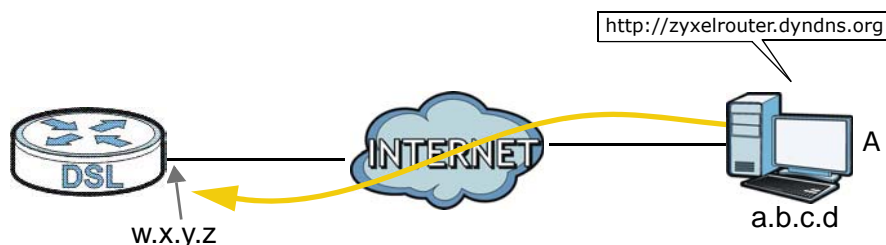

To use this feature, you have to apply for DDNS service at www.dyndns.org.

This tutorial shows you how to:

- [Registering a DDNS Account on \[www.dyndns.org\]\(http://www.dyndns.org\)](#)
- [Configuring DDNS on Your AMG1312-T Series](#)
- [Testing the DDNS Setting](#)

Note: If you have a private WAN IP address, then you cannot use DDNS.

4.11.1 Registering a DDNS Account on www.dyndns.org

- 1 Open a browser and type <http://www.dyndns.org>.

- 2 Apply for a user account. This tutorial uses **UserName1** and **12345** as the username and password.
- 3 Log into www.dyndns.org using your account.
- 4 Add a new DDNS host name. This tutorial uses the following settings as an example.
 - Hostname: **zyxelrouter.dyndns.org**
 - Service Type: **Host with IP address**
 - IP Address: Enter the WAN IP address that your AMG1312-T Series is currently using. You can find the IP address on the AMG1312-T Series's Web Configurator **Status** page.

Then you will need to configure the same account and host name on the AMG1312-T Series later.

4.11.2 Configuring DDNS on Your AMG1312-T Series

Configure the following settings in the **Network Setting > Dynamic DNS** screen.

- Select **Active Dynamic DNS**.
- Select **www.dyndns.org** in the **Service Provider** field.
- Type **zyxelrouter.dyndns.org** in the **Host Name** field.
- Enter the user name (**UserName1**) and password (**12345**).



Dynamic DNS Configuration

Dynamic DNS Enable Disable

Service Provider:

Host Name:

Username:

Password:

Click **Apply**.

4.11.3 Testing the DDNS Setting

Now you should be able to access the AMG1312-T Series from the Internet. To test this:

- 1 Open a web browser on the computer (using the IP address **a.b.c.d**) that is connected to the Internet.
- 2 Type **http://zyxelrouter.dyndns.org** and press [Enter].
- 3 The AMG1312-T Series's login page should appear. You can then log into the AMG1312-T Series and manage it.

PART II

Technical Reference

Connection Status and System Info Screens

5.1 Overview

After you log into the web configurator, the **Connection Status** screen appears. This shows the network connection status of the AMG1312-T Series and clients connected to it.

Use the **System Info** screen to look at the current status of the device, system resources and interfaces (LAN, WAN, WLAN).

5.2 The Connection Status Screen

Use this screen to view the network connection status of the device and its clients. A warning message appears if there is a connection problem.

If you prefer to view the status in a list, click **List View** in the **Viewing mode** selection box. You can configure how often you want the AMG1312-T Series to update this screen in **Refresh Interval**.

Figure 15 Connection Status: Icon View

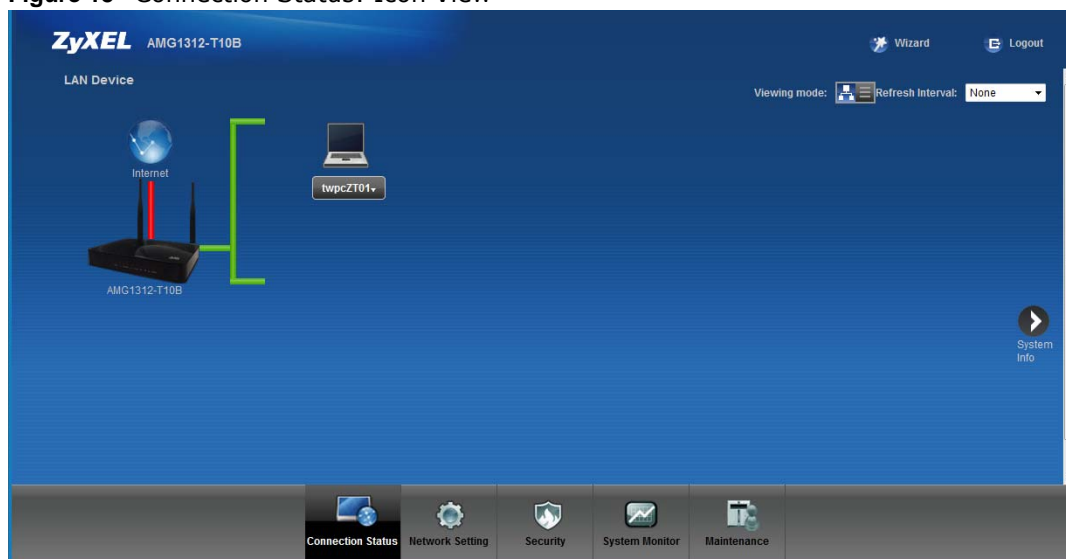

Figure 16 Connection Status: List View

#	Device Name	IP Address	Link-local IPv6 Address	Global IPv6 Address	MAC Address	Reserve
1	Unknown	192.168.1.60	N/A	N/A	6C:F0:49:70:12:C5	<input type="checkbox"/>
2	Unknown	192.168.1.11	N/A	N/A	00:24:1D:7F:34:05	<input type="checkbox"/>

In **Icon View**, if you want to view information about a client, click the client’s name and then click on **Info**.

In **List View**, you can also view the client’s information.

5.3 The System Info Screen

Click **Connection Status > System Info** to open this screen.

Figure 17 System Info Screen

Device Information

- Host Name: AMG1312-T10B
- Model Name: AMG1312-T10B
- MAC Address: D0 B2 DC 07 9B 99
- Firmware Version: V2.00(AFP_0a3)
- DSL Version: FWVer 3.20.36.0_A_TC3087 HwVer T14F7_11.2
- DSL Mode: N/A
- Annex Type: ANNEX A RJ45

WAN Information: WAN PVC0

- IPv6IPv4 Dual Stack: DualStack
- IP Address: 0.0.0.0
- IP Subnet Mask: 0.0.0.0
- Default Gateway: 0.0.0.0
- Primary DNS: 0.0.0.0
- Secondary DNS: 0.0.0.0
- IPv6 Global IP: -
- IPv6 Prefix Length: 0
- IPv6 Gateway: -
- IPv6 WAN DNS1: -
- IPv6 WAN DNS2: -
- Link-Local Address: -
- IPv6IPv4 MTU: -
- VPI/VCI: 0/33
- 3G Status: NoDevice
- 3G Rate: N/A
- 3G IP Address: 0.0.0.0
- 3G IP Subnet Mask: N/A
- 3G Gateway: N/A
- 3G Primary DNS: 0.0.0.0
- 3G Secondary DNS: 0.0.0.0

LAN Information:

- IP Address: 192.168.1.1
- IP Subnet Mask: 255.255.255.0
- DHCP: Server
- IPv6 Address: -
- Link-local IPv6 Address: fe80::1
- IPv6 Prefix: 0
- PreferredValid Time(sec): 3600/200
- DHCPv6: Server
- Radvd State: Enable
- IPv6 LAN DNS1: fe80::1
- IPv6 LAN DNS2: -

WLAN Information:

- Status: On
- SSID: ZYXEL_9B99
- Channel: 6
- Security Mode: WPA-PSK(WPA2-PSK)
- WPS: Unconfigured
- Scheduling: Disable
- WiFi MAC: D0 B2 DC 07 9B 99-B0 B2 DC 07 9B 99

3G Information:

- IP Address: -
- IP Subnet Mask: -
- Primary DNS: -
- Secondary DNS: -
- Gateway: -

Security: Firewall: Enable

Interface Status

Interface	Status	Rate
ADSL WAN	Down	N/A
LAN1	Down	N/A
LAN2	Down	N/A
LAN3	Down	N/A
LAN4	Up	100 Mbps/Full Duplex
WLAN	Active	300M
3G	NoDevice	N/A

System Status

- DSL Up Time: N/A
- System Up Time: 0 day 0 hour 3 minutes
- Current Date/Time: Fri Jan 1 00:03:56 UTC 2010
- PPPoE Up Time: 0
- System Resource:
 - CPU Usage: 2%
 - Memory Usage: 48%
 - DSL Down Bandwidth Usage: 0%
 - DSL Up Bandwidth Usage: 0%

USB Status

Type	Status
Storage	N/A

Each field is described in the following table.

Table 10 System Info Screen

LABEL	DESCRIPTION
Refresh Interval	Select how often you want the AMG1312-T Series to update this screen from the drop-down list box.
Device Information	
Host Name	This field displays the AMG1312-T Series system name. It is used for identification.
ModelName	This is the model name of your device.
MAC Address	This is the MAC (Media Access Control) or Ethernet address unique to your AMG1312-T Series.
Firmware Version	This field displays the current version of the firmware inside the device. It also shows the date the firmware version was created. Go to the Maintenance > Firmware Upgrade screen to change it.
DSL Version	This is the current version of the AMG1312-T Series's DSL modem code.
WAN Information	
DSL Mode	This is the method of encapsulation used by your ISP.
Annex Type	This is the ADSL Annex Type that your AMG1312-T Series is using.
IP Address	This field displays the current IP address of the AMG1312-T Series in the WAN.
IP Subnet Mask	This field displays the current subnet mask in the WAN.
Default Gateway	This is the IP address of the default gateway, if applicable.
Primary/Secondary DNS	This is the primary/secondary DNS server IP address assigned to the AMG1312-T Series.
IPv6 Global IP	This is the current IPv6 address of the AMG1312-T Series in the WAN. Click this to go to the screen where you can change it.
IPv6 Prefix Length	This is the current IPv6 prefix length in the WAN.
IPv6 Gateway	This is the IPv6 address of the default gateway, if applicable.
IPv6 WAN DNS1/2	This is the primary/secondary DNS server IPv6 address assigned to the AMG1312-T Series.
Link-Local Address	This is the link local address assigned to the AMG1312-T Series within the LAN.
IPv4/IPv6 MTU	This is the MTU (Maximum Transmission Unit) for IPv4 and IPv6 packets passing through the WAN interface.
VPI/VCI	This is the Virtual Path Identifier and Virtual Channel Identifier that you entered in the Network Setting > Broadband > Internet Connection screen.
LAN Information	
IP Address	This field displays the current IP address of the AMG1312-T Series in the LAN.
IP Subnet Mask	This field displays the current subnet mask in the LAN.
IPv6 Address	This is the current IPv6 address of the AMG1312-T Series in the LAN. Click this to go to the screen where you can change it.
IPv6 Prefix Length	This is the current IPv6 prefix length in the LAN.
IPv6 Prefix	This is the current IPv6 prefix in the LAN.

Table 10 System Info Screen (continued)

LABEL	DESCRIPTION
IPv6 Global IP	This is the current global IPv6 address of the AMG1312-T Series.
DHCP	This field displays what DHCP services the AMG1312-T Series is providing to the LAN. Choices are: Server - The AMG1312-T Series is a DHCP server in the LAN. It assigns IP addresses to other computers in the LAN. Relay - The AMG1312-T Series acts as a surrogate DHCP server and relays DHCP requests and responses between the remote server and the clients. None - The AMG1312-T Series is not providing any DHCP services to the LAN.
IPv6 LAN DNS1/2	This is the first/second DNS server IPv6 address the AMG1312-T Series passes to the DHCP clients.
WLAN Information	
Status	This displays whether wireless LAN is turned on or off.
SSID	This is the descriptive name used to identify the AMG1312-T Series in the wireless LAN.
Channel	This is the channel number used by the AMG1312-T Series now.
Security Mode	This displays the type of security the AMG1312-T Series is using in the wireless LAN.
WPS	Configured displays when the WPS security settings have been configured and wireless clients can connect with the device through WPS. Unconfigured displays when the device has not been configured and wireless clients can't establish a link with the device through WPS.
Scheduling	This displays whether WLAN scheduling is activated.
WiFi MAC	This is the MAC (Media Access Control) of the WiFi interface.
Security	
Firewall	This displays whether or not the AMG1312-T Series's firewall is activated. Click this to go to the screen where you can change it.
Interface Status	
Interface	This column displays each interface the AMG1312-T Series has.
Status	This field indicates whether or not the AMG1312-T Series is using the interface. For the DSL interface, this field displays Down (line is down), Up (line is up or connected), Initializing (line is initializing), Establishing Link (line is establishing a link) if you're using Ethernet encapsulation and Down (line is down), Up (line is up or connected), Idle (line (ppp) idle), Dial (starting to trigger a call) and Drop (dropping a call) if you're using PPPoE encapsulation. For the LAN interface, this field displays Up when the AMG1312-T Series is connected through an Ethernet cable to a computer or a HUB. It displays Down when the AMG1312-T Series's Ethernet port is disconnected. For the WLAN interface, it displays Active when WLAN is enabled or InActive when WLAN is disabled.
Rate	For the LAN interface, this displays the port speed. For the WAN interface, this displays the DSL link rate downstream and upstream. For the DSL interface, it displays the downstream and upstream transmission rate. For the WLAN interface, it displays the maximum transmission rate when WLAN is enabled or N/A when WLAN is disabled.
System Status	

Table 10 System Info Screen (continued)

LABEL	DESCRIPTION
DSL Up Time	This field displays how long the DSL connection has been active.
System Up Time	This field displays how long the AMG1312-T Series has been running since it last started up. The AMG1312-T Series starts up when you plug it in, when you restart it (Maintenance > Reboot), or when you reset it (see Chapter 1 on page 18).
Current Date/Time	This field displays the current date and time in the AMG1312-T Series. You can change this in Maintenance > Time Setting .
System Resource	
CPU Usage	This field displays what percentage of the AMG1312-T Series's processing ability is currently used. When this percentage is close to 100%, the AMG1312-T Series is running at full load, and the throughput is not going to improve anymore. If you want some applications to have more throughput, you should turn off other applications.
Memory Usage	This field displays what percentage of the AMG1312-T Series's memory is currently used. Usually, this percentage should not increase much. If memory usage does get close to 100% and remains like that for a high period of time, the AMG1312-T Series may become unstable and you should restart it. See Chapter 24 on page 209 , or turn off the device (unplug the power) for a few seconds.

Broadband

6.1 Overview

This chapter describes the AMG1312-T Series's **Broadband** screens. Use these screens to configure your AMG1312-T Series for Internet access.

A WAN (Wide Area Network) connection is an outside connection to another network or the Internet. It connects your private networks (such as a LAN (Local Area Network) and other networks, so that a computer in one location can communicate with computers in other locations.

Figure 18 LAN and WAN

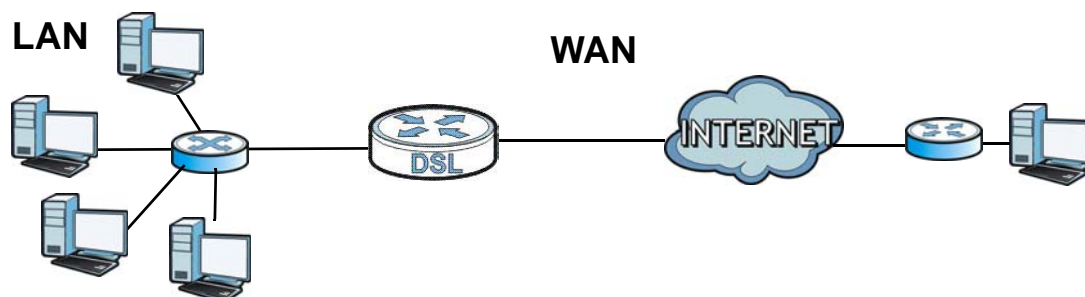

6.1.1 What You Can Do in the WAN Screens

- Use the **Internet Connection** screen ([Section 6.2 on page 69](#)) to configure the WAN settings on the AMG1312-T Series for Internet access.
- Use the **More Connections** screen ([Section 6.3 on page 75](#)) to set up additional Internet access connections.
- Use the **3G Backup** screen to configure 3G WAN connection ([Section 6.4 on page 80](#)).

6.1.2 What You Need to Know About WAN

Encapsulation Method

Encapsulation is used to include data from an upper layer protocol into a lower layer protocol. To set up a WAN connection to the Internet, you need to use the same encapsulation method used by your ISP (Internet Service Provider). If your ISP offers a dial-up Internet connection using PPPoE (PPP over Ethernet) or PPPoA, they should also provide a username and password (and service name) for user authentication.

WAN IP Address

The WAN IP address is an IP address for the AMG1312-T Series, which makes it accessible from an outside network. It is used by the AMG1312-T Series to communicate with other devices in other networks. It can be static (fixed) or dynamically assigned by the ISP each time the AMG1312-T Series tries to access the Internet.

If your ISP assigns you a static WAN IP address, they should also assign you the subnet mask and DNS server IP address(es) (and a gateway IP address if you use the Ethernet or ENET ENCAP encapsulation method).

Multicast

Traditionally, IP packets are transmitted in one of either two ways - Unicast (1 sender - 1 recipient) or Broadcast (1 sender - everybody on the network). Multicast delivers IP packets to a group of hosts on the network - not everybody and not just one.

IGMP

IGMP (Internet Group Multicast Protocol) is a network-layer protocol used to establish membership in a Multicast group - it is not used to carry user data. There are three versions of IGMP. IGMP version 2 and 3 are improvements over version 1, but IGMP version 1 is still in wide use.

IPv6

IPv6 (Internet Protocol version 6), is designed to increase IP address space and enhance features. The AMG1312-T Series supports IPv4/IPv6 dual stack and can connect to IPv4 and IPv6 networks. See ([Appendix E on page 277](#)) for more information about IPv6.

Finding Out More

See [Section 6.5 on page 82](#) for technical background information on WAN.

6.1.3 Before You Begin

You need to know your Internet access settings such as encapsulation and WAN IP address. Get this information from your ISP.

6.2 The Internet Connection Screen

Use this screen to change your AMG1312-T Series's WAN settings. Click **Network Setting > Broadband > Internet Connection**. The screen differs by the WAN type and encapsulation you select.

Figure 19 Network Setting > Broadband > Internet Connection > Auto Sync Up

Line	
Type	Auto Sync-Up
General	
Mode	Router
Encapsulation	PPPoE
User Name	ChangeMe
Password	••••••••
Service Name	
Multiplex	LLC
IPv6/IPv4 Dual Stack	IPv4/IPv6
PPP Authentication	Auto
Virtual Circuit ID	
VPI	0 (Range : 0~255)
VCI	33 (Range : 32~65535)
IP Address	
<input checked="" type="radio"/> Obtain an IP Address Automatically <input type="radio"/> Static IP Address	
IP Address	0.0.0.0
Routing Feature	
<input checked="" type="checkbox"/> Apply as Default Gateway	
DNS Server	
Primary DNS	Obtained From ISP 0.0.0.0
Secondary DNS	Obtained From ISP 0.0.0.0
IPv6 Address	
<input checked="" type="radio"/> Obtain an IP Address Automatically <input type="radio"/> DHCP IPv6 <input type="radio"/> SLAAC <input type="radio"/> Auto	
DHCP PD	<input checked="" type="radio"/> Enable <input type="radio"/> Disable
WAN Identifier Type	<input type="radio"/> Manual <input checked="" type="radio"/> EUI64
WAN Identifier	
Bridge and Routing mode in the same WAN	
<input type="checkbox"/> Enable Con-current WAN	
Connection	
<input checked="" type="radio"/> Keep Alive <input type="radio"/> Connect on Demand	
Max Idle Time	0 Sec
<input type="button" value="Apply"/> <input type="button" value="Cancel"/> <input type="button" value="Advanced Setup"/>	

The following table describes the labels in this screen.

Table 11 Network Setting > Broadband > Internet Connection

LABEL	DESCRIPTION
Line	
Type	<p>Select the DSL mode supported by your ISP.</p> <p>Use Auto Sync-Up if you are not sure which mode to choose from. The AMG1312-T Series dynamically diagnoses the mode supported by the ISP and selects the best compatible one for your connection.</p> <p>Other options are ADSL2+, ADSL2, G.DMT, T1.413 and G.lite.</p> <p>The AMG1312-T Series device supports Ethernet (ETH1) mode. To select this mode, connect a modem or router to the WAN port and select Ethernet (ETH1).</p> <p>Note: The AMG1312-T Series reboots when transferring to and from Ethernet (ETH1) type.</p>
General	
Mode	<p>Select Router (default) from the drop-down list box if your ISP gives you one IP address only and you want multiple computers to share an Internet account. Select Bridge when your ISP provides you more than one IP address and you want the connected computers to get individual IP address from ISP's DHCP server directly. If you select Bridge, you cannot use Firewall, DHCP server and NAT on the AMG1312-T Series.</p>
Encapsulation	<p>Select the method of encapsulation used by your ISP from the drop-down list box. Choices vary depending on the mode you select in the Mode field.</p> <p>If you select Router in the Mode field, select PPPoA, RFC 1483, ENET ENCAP or PPPoE.</p> <p>If you select Bridge in the Mode field, method of encapsulation is not available.</p>
User Name	<p>(PPPoA and PPPoE encapsulation only) Enter the user name exactly as your ISP assigned. If assigned a name in the form user@domain where domain identifies a service name, then enter both components exactly as given.</p>
Password	<p>(PPPoA and PPPoE encapsulation only) Enter the password associated with the user name above.</p>
Service Name	<p>(PPPoE only) Type the name of your PPPoE service here.</p>
Multiplex	<p>Select the method of multiplexing used by your ISP from the drop-down list. Choices are VC or LLC.</p>
IPv6/IPv4 Dual Stack	<p>If you select Enable, the AMG1312-T Series can connect to IPv4 and IPv6 networks and choose the protocol for applications according to the address type. If you select Disable, the AMG1312-T Series will operate in IPv4 mode.</p>
PPP Authentication	<p>The AMG1312-T Series supports PAP (Password Authentication Protocol) and CHAP (Challenge Handshake Authentication Protocol). CHAP is more secure than PAP; however, PAP is readily available on more platforms.</p> <p>Use the drop-down list box to select an authentication protocol for outgoing calls. Options are:</p> <p>AUTO - Your AMG1312-T Series accepts either CHAP or PAP when requested by this remote node.</p> <p>CHAP - Your AMG1312-T Series accepts CHAP only.</p> <p>PAP - Your AMG1312-T Series accepts PAP only.</p>
Virtual Circuit ID	<p>VPI (Virtual Path Identifier) and VCI (Virtual Channel Identifier) define a virtual circuit. Refer to the appendix for more information.</p>

Table 11 Network Setting > Broadband > Internet Connection (continued)

LABEL	DESCRIPTION
VPI	This option is available if you select Router in the Mode field. The valid range for the VPI is 0 to 255. Enter the VPI assigned to you.
VCI	This option is available if you select Router in the Mode field. The valid range for the VCI is 32 to 65535 (0 to 31 is reserved for local management of ATM traffic). Enter the VCI assigned to you.
IP Address	
Obtain an IP Address Automatically Static IP Address	This option is available if you select Router in the Mode field. A static IP address is a fixed IP that your ISP gives you. A dynamic IP address is not fixed; the ISP assigns you a different one each time you connect to the Internet. Select Obtain an IP Address Automatically if you have a dynamic IP address; otherwise select Static IP Address and type your ISP assigned IP address in the IP Address field and a gateway IP address (supplied by your ISP) below.
Routing Feature	
Apply as Default Gateway	Select this option to have the AMG1312-T Series use the WAN interface of this connection as the system default gateway.
DNS Server - This section is not available when you select Bridge in the Mode field.	
Primary DNS Server Secondary DNS Server	Select Obtained from ISP to have the AMG1312-T Series get the DNS server addresses from the ISP automatically. Select UserDefined and enter the DNS server address assigned by the ISP. Select None to not configure a DNS server. You must know the IP address of amachine in order to access it.
IPv6 Address	
Obtain an IP Address Automatically	Select this option if you want to have the AMG1312-T Series use the IPv6 prefix from the connected router's Router Advertisement (RA) to generate an IPv6 address.
DHCP IPv6	Select DHCP if you want to obtain an IPv6 address from a DHCPv6 server. The IP address assigned by a DHCPv6 server has priority over the IP address automatically generated by the AMG1312-T Series using the IPv6 prefix from an RA. Select SLAAC (Stateless address autoconfiguration) to have the AMG1312-T Series use the prefix to automatically generate a unique IP address that does not need to be maintained by a DHCP server. Select Auto to have the AMG1312-T Series indicate to hosts for IPv6 address generation depending on the M/O (Managed/Other) flag values in the router advertisements sending to hosts. <ul style="list-style-type: none"> • If M flag is 1, the AMG1312-T Series will indicate to hosts to obtain network settings (such as WAN IP, LAN prefix and DNS settings) through DHCPv6. • If M flag is 0, the AMG1312-T Series will check O flag. • If O flag is 1, the AMG1312-T Series will indicate to hosts to obtain DNS information and LAN prefix through DHCPv6. • If O flag is 0, the AMG1312-T Series will not get information through DHCPv6.
DHCP PD	Select Enable to use DHCP PD (Prefix Delegation) to allow the AMG1312-T Series to pass the IPv6 prefix information to its LAN hosts. The hosts can then use the prefix to generate their IPv6 addresses.
WAN Identifier Type	Select Manual to manually enter a WAN Identifier as the interface ID to identify the WAN interface. The WAN Identifier is appended to the IPv6 address prefix to create the routable global IPv6 address. Select EUI 64 to use the EUI-64 format to generate an interface ID from the MAC address of the WAN interface.

Table 11 Network Setting > Broadband > Internet Connection (continued)

LABEL	DESCRIPTION
WAN Identifier	If you selected Manual , enter the WAN Identifier in this field. The WAN identifier should be unique and 64 bits in hexadecimal form. Every 16 bit block should be separated by a colon as in XXXX:XXXX:XXXX:XXXX where X is a hexadecimal character. Blocks of zeros can be represented with double colons as in XXXX:XXXX::XXXX.
Bridge and Routing mode in the same WAN (ENET ENCAP and PPPoE encapsulation only) This feature allows you to set some LAN port(s) and/or SSID(s) to be in bridge mode with the WAN interface, while other LAN port(s) and SSID(s) can still use Firewall, DHCP server and NAT on the AMG1312-T Series.	
Enable Con-current WAN	Select this option to bridge traffic between the WAN interface and certain Ethernet port(s) and/or SSID(s). Other ports and SSIDs will be still in router mode with the WAN interface. Note: The port binding feature will be disabled automatically when you select this option.
Connection (PPPoA and PPPoE encapsulation only)	
Keep Alive	Select Keep Alive when you want your connection up all the time. The AMG1312-T Series will try to bring up the connection automatically if it is disconnected. Note: Do not specify an always-on connection unless your telephone company offers flat-rate service or you need a constant connection and the cost is of no concern.
Connect on Demand	Select Connect on Demand when you don't want the connection up all the time and specify an idle time-out in seconds.
Apply	Click this to save your changes.
Cancel	Click this to restore your previously saved settings.
Advanced Setup	Click this to display the Advanced WAN Setup screen and edit more details of your WAN setup. Click this button again to display less fields in this screen.

6.2.1 Advanced Setup

Use this screen to edit your AMG1312-T Series's advanced WAN settings. Click the **Advanced Setup** button in the **Internet Connection** screen. The screen appears as shown.

Figure 20 Network Setting > Broadband > Internet Connection: Advanced Setup

RIP & Multicast Setup	
RIP Direction	None
RIP Version	RIP1
Multicast	None
MLD Proxy	None
ATM QoS	
ATM QoS Type	UBR With PCR
Peak Cell Rate	0 cell/sec
Sustain Cell Rate	0 cell/sec
Maximum Burst Size	0 cell
PPPoE Passthrough	No
MTU	
MTU	1492
<input type="button" value="Apply"/> <input type="button" value="Cancel"/> <input type="button" value="Advanced Setup"/>	

The following table describes the labels in this screen.

Table 12 Network Setting > Broadband > Internet Connection: Advanced Setup

LABEL	DESCRIPTION
RIP Direction	RIP (Routing Information Protocol) allows a router to exchange routing information with other routers. Use this field to control how much routing information the AMG1312-T Series sends and receives on the subnet. Select the RIP direction from None , Both , In Only and Out Only .
RIP Version	This field is not configurable if you select None in the RIP Direction field. Select the RIP version from RIP-1 , RIP2-B and RIP2-M .
Multicast	Multicast packets are sent to a group of computers on the LAN and are an alternative to unicast packets (packets sent to one computer) and broadcast packets (packets sent to every computer). Internet Group Multicast Protocol (IGMP) is a network-layer protocol used to establish membership in a multicast group. The AMG1312-T Series supports IGMP-v1 , IGMP-v2 and IGMP-v3 . Select None to disable it.
MLD Proxy	Select the version of MLD proxy (v1 or v2) to have the AMG1312-T Series act as for this connection. This allows the AMG1312-T Series to get subscription information and maintain a joined member list for each multicast group. It can reduce multicast traffic significantly. Select None to turn off MLD proxy.
ATM QoS	
ATM QoS Type	Select CBR (Continuous Bit Rate) to specify fixed (always-on) bandwidth for voice or data traffic. Select UBR With PCR (Unspecified Bit Rate) for applications that are non-time sensitive, such as e-mail. Select Realtime VBR (real-time Variable Bit Rate) type for applications with bursty connections that require closely controlled delay and delay variation. Select Non Realtime VBR (non real-time Variable Bit Rate) type for connections that do not require closely controlled delay and delay variation.
Peak Cell Rate	Divide the DSL line rate (bps) by 424 (the size of an ATM cell) to find the Peak Cell Rate (PCR). This is the maximum rate at which the sender can send cells. Type the PCR here.















Table 12 Network Setting > Broadband > Internet Connection: Advanced Setup (continued)















LABEL	DESCRIPTION
Sustain Cell Rate	The Sustain Cell Rate (SCR) sets the average cell rate (long-term) that can be transmitted. Type the SCR, which must be less than the PCR. Note that system default is 0 cells/sec.
Maximum Burst Size	Maximum Burst Size (MBS) refers to the maximum number of cells that can be sent at the peak rate. Type the MBS, which is less than 65535.
PPPoE Passthrough	If encapsulation type is PPPoE, select this to enable PPPoE Passthrough. In addition to the Device's built-in PPPoE client, you can select this to allow hosts on the LAN to use PPPoE client software on their computers to connect to the ISP via the device. Each host can have a separate account and a public WAN IP address.
MTU	
MTU	The Maximum Transmission Unit (MTU) defines the size of the largest packet allowed on an interface or connection. Enter the MTU in this field. For ENET ENCAP, the MTU value is 1500. For PPPoE, the MTU value is 1492. For PPPoA and RFC 1483, the MTU is 65535.

6.3 The More Connections Screen

The AMG1312-T Series allows you to configure more than one Internet access connection. To configure additional Internet access connections click **Network Setting > Broadband > More Connections**. The screen differs by the encapsulation you select. When you use the **Broadband > Internet Connection** screen to set up Internet access, you are configuring the first WAN connection.

Figure 21 Network Setting > Broadband > More Connections

#	Active	Node Name	VPI/VCI	Encapsulation	Modify
1	<input checked="" type="checkbox"/>	Wan_PVC0	0/33	PPPoA LLLC	
2	<input type="checkbox"/>	N/A	--/--	--	 
3	<input type="checkbox"/>	N/A	--/--	--	 
4	<input type="checkbox"/>	N/A	--/--	--	 
5	<input type="checkbox"/>	N/A	--/--	--	 
6	<input type="checkbox"/>	N/A	--/--	--	 
7	<input type="checkbox"/>	N/A	--/--	--	 
8	<input type="checkbox"/>	N/A	--/--	--	 

Ethernet Connections Table					
#	Active	Node Name	VID	Encapsulation	Modify
1	<input checked="" type="checkbox"/>	Ethernet_WAN0	--	PPPoE	
2	<input type="checkbox"/>	N/A	--	--	 
3	<input type="checkbox"/>	N/A	--	--	 
4	<input type="checkbox"/>	N/A	--	--	 
5	<input type="checkbox"/>	N/A	--	--	 
6	<input type="checkbox"/>	N/A	--	--	 
7	<input type="checkbox"/>	N/A	--	--	 
8	<input type="checkbox"/>	N/A	--	--	 

The following table describes the labels in this screen.

Table 13 Network Setting > Broadband > More Connections

LABEL	DESCRIPTION
ADSL Connections Table	
#	This is an index number indicating the number of the corresponding connection.
Active	This field indicates whether the connection is active or not. Clear the check box to disable the connection. Select the check box to enable it.
Node Name	This is the name you gave to the Internet connection.
VPI/VCI	This field displays the Virtual Path Identifier (VPI) and Virtual Channel Identifier (VCI) numbers configured for this WAN connection.
Encapsulation	This field indicates the encapsulation method of the Internet connection.
Modify	The first (ISP) connection is read-only in this screen. Use the Broadband > Internet Connection screen to edit it. Click the Edit icon to edit the Internet connection settings. Click this icon on an empty configuration to add a new Internet access setup. Click the Remove icon to delete the Internet access setup from your connection list.
Ethernet Connections Table	
#	This is an index number indicating the number of the corresponding connection.
Active	This field indicates whether the connection is active or not. Clear the check box to disable the connection. Select the check box to enable it.
Node Name	This is the name you gave to the Internet connection.
VID	This field displays the VLAN ID number used by this connection.
Encapsulation	This field indicates the encapsulation method of the Internet connection.
Modify	The first (ISP) connection is read-only in this screen. Use the Broadband > Internet Connection screen to edit it. Click the Edit icon to edit the Internet connection settings. Click this icon on an empty configuration to add a new Internet access setup. Click the Remove icon to delete the Internet access setup from your connection list.

6.3.1 More Connections Edit

Use this screen to configure a connection. Click the edit icon in the **More Connections** screen to display the following screen.

Figure 22 Network Setting > Broadband > More Connections: Edit

General	
<input type="checkbox"/> Active	
Node Name	<input type="text"/>
Mode	Router <input type="button" value="v"/>
Encapsulation	ENET ENCAP <input type="button" value="v"/>
Multiplex	VC-Mux <input type="button" value="v"/>
IPv6/IPv4 Dual Stack	IPv4 <input type="button" value="v"/>
VPI	<input type="text"/> (Range : 0-255)
VCI	<input type="text"/> (Range : 32-65535)
IP Address	
<input checked="" type="radio"/> Obtain an IP Address Automatically	
<input type="radio"/> Static IP Address	
IP Address	<input type="text"/> 0.0.0.0
Subnet Mask	<input type="text"/> 0.0.0.0
Gateway IP Address	<input type="text"/> 0.0.0.0
Primary DNS	<input type="text"/> 0.0.0.0
Secondary DNS	<input type="text"/> 0.0.0.0
NAT	
<input checked="" type="radio"/> None	
<input type="radio"/> SUA Only	
Advanced Setup ▲	
RIP & Multicast Setup	
RIP Direction	Both <input type="button" value="v"/>
RIP Version	RIP1 <input type="button" value="v"/>
Multicast	None <input type="button" value="v"/>
ATM QoS	
ATM QoS Type	UBR With PCR <input type="button" value="v"/>
Peak Cell Rate	<input type="text"/> 0 cell/sec
Sustain Cell Rate	<input type="text"/> 0 cell/sec
Maximum Burst Size	<input type="text"/> 0 cell
MTU	
MTU	<input type="text"/> 1500
<input type="button" value="Apply"/> <input type="button" value="Cancel"/>	

The following table describes the labels in this screen.

Table 14 Network Setting > Broadband > More Connections: Edit

LABEL	DESCRIPTION
General	
Active	Select the check box to activate or clear the check box to deactivate this connection.

Table 14 Network Setting > Broadband > More Connections: Edit (continued)

LABEL	DESCRIPTION
Node Name	Enter a unique, descriptive name of up to 13 ASCII characters for this connection.
Mode	Select Router from the drop-down list box if your ISP allows multiple computers to share an Internet account. If you select Bridge , the AMG1312-T Series will forward any packet that it does not route to this remote node; otherwise, the packets are discarded.
Encapsulation	Select the method of encapsulation used by your ISP from the drop-down list box. Choices vary depending on the mode you select in the Mode field. If you select Router in the Mode field, select PPPoA , RFC 1483 , ENET ENCAP or PPPoE . If you select Bridge in the Mode field, method of encapsulation is not available.
Multiplex	Select the method of multiplexing used by your ISP from the drop-down list. Choices are VC or LLC . By prior agreement, a protocol is assigned a specific virtual circuit, for example, VC1 will carry IP. If you select VC, specify separate VPI and VCI numbers for each protocol. For LLC-based multiplexing or PPP encapsulation, one VC carries multiple protocols with protocol identifying information being contained in each packet header. In this case, only one set of VPI and VCI numbers need be specified for all protocols.
IPv6/IPv4 Dual Stack	If you select Enable , the AMG1312-T Series can connect to IPv4 and IPv6 networks and choose the protocol for applications according to the address type. If you select Disable , the AMG1312-T Series will operate in IPv4 mode.
VPI	The valid range for the VPI is 0 to 255. Enter the VPI assigned to you.
VCI	The valid range for the VCI is 32 to 65535 (0 to 31 is reserved for local management of ATM traffic). Enter the VCI assigned to you.
IP Address	This option is available if you select Router in the Mode field. A static IP address is a fixed IP that your ISP gives you. A dynamic IP address is not fixed; the ISP assigns you a different one each time you connect to the Internet. If you use the encapsulation type except RFC 1483 , select Obtain an IP Address Automatically when you have a dynamic IP address; otherwise select Static IP Address and type your ISP assigned IP address in the IP Address field below. If you use RFC 1483 , enter the IP address given by your ISP in the IP Address field.
Subnet Mask	Enter a subnet mask in dotted decimal notation.
Gateway IP Address	Specify a gateway IP address (supplied by your ISP).
Primary DNS	Enter the primary DNS server's address for the AMG1312-T Series.
Secondary DNS	Enter the secondary DNS server's address for the AMG1312-T Series.
NAT	SUA Only is available only when you select Router in the Mode field. Select SUA Only if you have one public IP address and want to use NAT. Otherwise, select None to disable NAT.
Apply	Click this to save your changes.
Cancel	Click this to return to the previous screen without saving.
Advanced Setup	Click this to display more fields in this screen to configure more details of your WAN settings.

6.3.2 Configuring More Connections Advanced Setup

Use this screen to edit your AMG1312-T Series's advanced WAN settings. Click the **Advanced Setup** arrow icon in the **More Connections Edit** screen. The screen appears as shown.

Figure 23 Network Setting > Broadband > More Connections: Edit: Advanced Setup

Advanced Setup ▲

RIP & Multicast Setup

RIP Direction: Both

RIP Version: RIP1

Multicast: None

ATM QoS

ATM QoS Type: UBR With PCR

Peak Cell Rate: 0 cell/sec

Sustain Cell Rate: 0 cell/sec

Maximum Burst Size: 0 cell

MTU

MTU: 1500

Apply Cancel

The following table describes the labels in this screen.

Table 15 Network Setting > Broadband > More Connections: Edit: Advanced Setup

LABEL	DESCRIPTION
RIP & Multicast Setup	
RIP Direction	Select the RIP Direction from None , Both , In Only and Out Only .
RIP Version	This field is not configurable if you select None in the RIP Direction field. Select the RIP Version from RIP-1 , RIP2-B and RIP2-M .
Multicast	Internet Group Multicast Protocol (IGMP) is a network-layer protocol used to establish membership in a multicast group. The AMG1312-T Series supports IGMP-v1 , IGMP-v2 and IGMP-v3 . Select None to disable it.
ATM QoS	
ATM QoS Type	Select CBR (Continuous Bit Rate) to specify fixed (always-on) bandwidth for voice or data traffic. Select UBR (Unspecified Bit Rate) for applications that are non-time sensitive, such as e-mail. Select nrtVBR (Variable Bit Rate-non Real Time) or rtVBR (Variable Bit Rate-Real Time) for bursty traffic and bandwidth sharing with other applications.
Peak Cell Rate	Divide the DSL line rate (bps) by 424 (the size of an ATM cell) to find the Peak Cell Rate (PCR). This is the maximum rate at which the sender can send cells. Type the PCR here.
Sustain Cell Rate	The Sustain Cell Rate (SCR) sets the average cell rate (long-term) that can be transmitted. Type the SCR, which must be less than the PCR. Note that system default is 0 cells/sec.
Maximum Burst Size	Maximum Burst Size (MBS) refers to the maximum number of cells that can be sent at the peak rate. Type the MBS, which is less than 65535.
MTU	

Table 15 Network Setting > Broadband > More Connections: Edit: Advanced Setup (continued)

LABEL	DESCRIPTION
MTU	The Maximum Transmission Unit (MTU) defines the size of the largest packet allowed on an interface or connection. Enter the MTU in this field. For ENET ENCAP, the MTU value is 1500. For PPPoE, the MTU value is 1492. For PPPoA and RFC, the MTU is 100-1500.
Apply	Click this to save your changes.
Cancel	Click this to restore your previously saved settings.

6.4 The 3G Backup Screen

The USB ports (at the left side panel of the AMG1312-T Series) allow you to attach a 3G dongle to wirelessly connect to a 3G network for Internet access. You can have the AMG1312-T Series use the 3G WAN connection as a backup. Disconnect the DSL and Ethernet WAN ports to use the 3G dongle as your primary WAN connection. The AMG1312-T Series automatically uses a wired WAN connection when available.

Note: This AMG1312-T Series supports connecting one 3G dongle at a time.

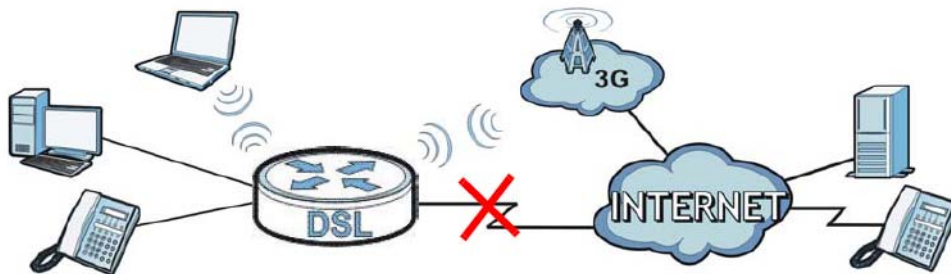
Figure 24 Internet Access Application: 3G WAN

Use this screen to configure your 3G settings. Click **Network Setting > Broadband > 3G Backup**.

Note: The actual data rate you obtain varies depending the 3G card you use, the signal strength to the service provider's base station, and so on.

Figure 25 Network Setting > Broadband > 3G Backup

General

3G Backup Enable 3G Backup

Card Description No Card

Username (Optional)

Password (Optional)

PIN (Optional) Only for unlock PIN next time
(PIN remaining authentication times: N/A)

Dial String *99#

APN internet

IP Address

Obtain an IP Address Automatically

Use the Following Static IP Address

IP Address

DNS Server

Obtain DNS Info Dynamically

Use the Following Static DNS IP Address

Primary DNS Server

Secondary DNS Server

Connection

Keep Alive

Connect on Demand

Max Idle Time 0 Sec

NAT

Active

Apply Cancel

The following table describes the labels in this screen.

Table 16 Network Setting > Broadband > 3G Backup

LABEL	DESCRIPTION
General	
3G Backup	Select Enable to have the AMG1312-T Series use the 3G connection as your WAN or a backup when the wired WAN connection fails.
Card description	This field displays the manufacturer and model name of your 3G card if you inserted one in the AMG1312-T Series. Otherwise, it displays N/A .
Username	Type the user name (of up to 64 ASCII printable characters) given to you by your service provider.
Password	Type the password (of up to 64 ASCII printable characters) associated with the user name above.
PIN	A PIN (Personal Identification Number) code is a key to a 3G card. Without the PIN code, you cannot use the 3G card. If your ISP enabled PIN code authentication, enter the 4-digit PIN code (0000 for example) provided by your ISP. If you enter the PIN code incorrectly, the 3G card may be blocked by your ISP and you cannot use the account to access the Internet. If your ISP disabled PIN code authentication, leave this field blank.

Table 16 Network Setting > Broadband > 3G Backup (continued)

LABEL	DESCRIPTION
Dial string	Enter the phone number (dial string) used to dial up a connection to your service provider's base station. Your ISP should provide the phone number. For example, *99# is the dial string to establish a GPRS or 3G connection in Taiwan.
APN	Enter the APN (Access Point Name) provided by your service provider. Connections with different APNs may provide different services (such as Internet access or MMS (Multi-Media Messaging Service)) and charge method. You can enter up to 32 ASCII printable characters. Spaces are allowed.
IP Address	
Obtain DNS info dynamically	Select this to have the AMG1312-T Series get the DNS server addresses from the ISP automatically.
Use the following static IP address	Select this to have the AMG1312-T Series use the DNS server addresses you configure manually.
IP Address	Enter your WAN IP address in this field if you selected Use the following static IP address .
DNS server	
Obtain DNS info dynamically	Select this to have the Device get the DNS server addresses from the ISP automatically.
Use the following static DNS IP address	Select this to have the Device use the DNS server addresses you configure manually.
Primary DNS server	Enter the first DNS server address assigned by the ISP.
Secondary DNS server	Enter the second DNS server address assigned by the ISP.
Connection	
Keep alive	Select this to enable the keep alive function.
Connect on demand	Select Connect on Demand if you do not want the connection up all the time and specify an idle time in the Max Idle Time field.
NAT	
Active	Select Active to start the NAT on the AMG1312-T Series.
Apply	Click Apply to save your changes back to the AMG1312-T Series.
Cancel	Click Cancel to return to the previous configuration.

6.5 WAN Technical Reference

This section provides some technical background information about the topics covered in this chapter.

6.5.1 Encapsulation

Be sure to use the encapsulation method required by your ISP. The AMG1312-T Series supports the following methods.

6.5.1.1 ENET ENCAP

The MAC Encapsulated Routing Link Protocol (ENET ENCAP) is only implemented with the IP network protocol. IP packets are routed between the Ethernet interface and the WAN interface and then formatted so that they can be understood in a bridged environment. For instance, it encapsulates routed Ethernet frames into bridged ATM cells. ENET ENCAP requires that you specify a gateway IP address in the **Gateway IP Address** field in the wizard or WAN screen. You can get this information from your ISP.

6.5.1.2 PPP over Ethernet

The AMG1312-T Series supports PPPoE (Point-to-Point Protocol over Ethernet). PPPoE is an IETF Draft standard (RFC 2516) specifying how a personal computer (PC) interacts with a broadband modem (DSL, cable, wireless, etc.) connection. The PPPoE option is for a dial-up connection using PPPoE.

For the service provider, PPPoE offers an access and authentication method that works with existing access control systems (for example RADIUS).

One of the benefits of PPPoE is the ability to let you access one of multiple network services, a function known as dynamic service selection. This enables the service provider to easily create and offer new IP services for individuals.

Operationally, PPPoE saves significant effort for both you and the ISP or carrier, as it requires no specific configuration of the broadband modem at the customer site.

By implementing PPPoE directly on the AMG1312-T Series (rather than individual computers), the computers on the LAN do not need PPPoE software installed, since the AMG1312-T Series does that part of the task. Furthermore, with NAT, all of the LANs' computers will have access.

6.5.1.3 PPPoA

PPPoA stands for Point to Point Protocol over ATM Adaptation Layer 5 (AAL5). A PPPoA connection functions like a dial-up Internet connection. The AMG1312-T Series encapsulates the PPP session based on RFC1483 and sends it through an ATM PVC (Permanent Virtual Circuit) to the Internet Service Provider's (ISP) DSLAM (Digital Subscriber Line (DSL) Access Multiplexer). Please refer to RFC 2364 for more information on PPPoA. Refer to RFC 1661 for more information on PPP.

6.5.1.4 RFC 1483

RFC 1483 describes two methods for Multiprotocol Encapsulation over ATM Adaptation Layer 5 (AAL5). The first method allows multiplexing of multiple protocols over a single ATM virtual circuit (LLC-based multiplexing) and the second method assumes that each protocol is carried over a separate ATM virtual circuit (VC-based multiplexing). Please refer to RFC 1483 for more detailed information.

6.5.2 Multiplexing

There are two conventions to identify what protocols the virtual circuit (VC) is carrying. Be sure to use the multiplexing method required by your ISP.

VC-based Multiplexing

In this case, by prior mutual agreement, each protocol is assigned to a specific virtual circuit; for example, VC1 carries IP, etc. VC-based multiplexing may be dominant in environments where dynamic creation of large numbers of ATM VCs is fast and economical.

LLC-based Multiplexing

In this case one VC carries multiple protocols with protocol identifying information being contained in each packet header. Despite the extra bandwidth and processing overhead, this method may be advantageous if it is not practical to have a separate VC for each carried protocol, for example, if charging heavily depends on the number of simultaneous VCs.

6.5.3 VPI and VCI

Be sure to use the correct Virtual Path Identifier (VPI) and Virtual Channel Identifier (VCI) numbers assigned to you. The valid range for the VPI is 0 to 255 and for the VCI is 32 to 65535 (0 to 31 is reserved for local management of ATM traffic). Please see the appendix for more information.

6.5.4 IP Address Assignment

A static IP is a fixed IP that your ISP gives you. A dynamic IP is not fixed; the ISP assigns you a different one each time. The Single User Account feature can be enabled or disabled if you have either a dynamic or static IP. However the encapsulation method assigned influences your choices for IP address and ENET ENCAP gateway.

IP Assignment with PPPoA or PPPoE Encapsulation

If you have a dynamic IP, then the **IP Address** and **Gateway IP Address** fields are not applicable (N/A). If you have a **Static IP Address** assigned by your ISP, then they should also assign you a **Subnet Mask** and a **Gateway IP Address**.

IP Assignment with RFC 1483 Encapsulation

In this case the IP address assignment must be static.

IP Assignment with ENET ENCAP Encapsulation

In this case you can have either a static or dynamic IP. For a static IP you must fill in all the **IP Address** and **Gateway IP Address** fields as supplied by your ISP. However for a dynamic IP, the AMG1312-T Series acts as a DHCP client on the WAN port and so the **IP Address** and **Gateway IP Address** fields are not applicable (N/A) as the DHCP server assigns them to the AMG1312-T Series.

6.5.5 Nailed-Up Connection (PPP)

A nailed-up connection is a dial-up line where the connection is always up regardless of traffic demand. The AMG1312-T Series does two things when you specify a nailed-up connection. The first is that idle timeout is disabled. The second is that the AMG1312-T Series will try to bring up the connection when turned on and whenever the connection is down. A nailed-up connection can be very expensive for obvious reasons.

Do not specify a nailed-up connection unless your telephone company offers flat-rate service or you need a constant connection and the cost is of no concern.

6.5.6 NAT

NAT (Network Address Translation - NAT, RFC 1631) is the translation of the IP address of a host in a packet, for example, the source address of an outgoing packet, used within one network to a different IP address known within another network.

6.6 Traffic Shaping

Traffic Shaping is an agreement between the carrier and the subscriber to regulate the average rate and fluctuations of data transmission over an ATM network. This agreement helps eliminate congestion, which is important for transmission of real time data such as audio and video connections.

Peak Cell Rate (PCR) is the maximum rate at which the sender can send cells. This parameter may be lower (but not higher) than the maximum line speed. 1 ATM cell is 53 bytes (424 bits), so a maximum speed of 832Kbps gives a maximum PCR of 1962 cells/sec. This rate is not guaranteed because it is dependent on the line speed.

Sustained Cell Rate (SCR) is the mean cell rate of each bursty traffic source. It specifies the maximum average rate at which cells can be sent over the virtual connection. SCR may not be greater than the PCR.

Maximum Burst Size (MBS) is the maximum number of cells that can be sent at the PCR. After MBS is reached, cell rates fall below SCR until cell rate averages to the SCR again. At this time, more cells (up to the MBS) can be sent at the PCR again.

If the PCR, SCR or MBS is set to the default of "0", the system will assign a maximum value that correlates to your upstream line rate.

The following figure illustrates the relationship between PCR, SCR and MBS.

Figure 26 Example of Traffic Shaping

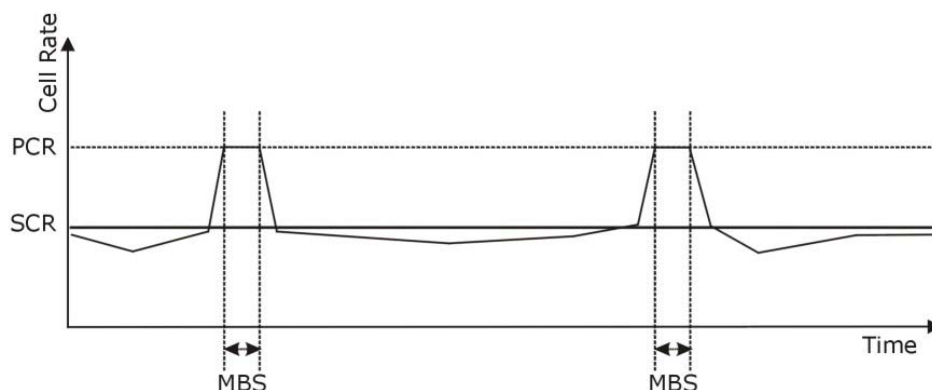

6.6.1 ATM Traffic Classes

These are the basic ATM traffic classes defined by the ATM Forum Traffic Management 4.0 Specification.

Constant Bit Rate (CBR)

Constant Bit Rate (CBR) provides fixed bandwidth that is always available even if no data is being sent. CBR traffic is generally time-sensitive (doesn't tolerate delay). CBR is used for connections that continuously require a specific amount of bandwidth. A PCR is specified and if traffic exceeds this rate, cells may be dropped. Examples of connections that need CBR would be high-resolution video and voice.

Variable Bit Rate (VBR)

The Variable Bit Rate (VBR) ATM traffic class is used with bursty connections. Connections that use the Variable Bit Rate (VBR) traffic class can be grouped into real time (VBR-RT) or non-real time (VBR-nRT) connections.

The VBR-RT (real-time Variable Bit Rate) type is used with bursty connections that require closely controlled delay and delay variation. It also provides a fixed amount of bandwidth (a PCR is specified) but is only available when data is being sent. An example of an VBR-RT connection would be video conferencing. Video conferencing requires real-time data transfers and the bandwidth requirement varies in proportion to the video image's changing dynamics.

The VBR-nRT (non real-time Variable Bit Rate) type is used with bursty connections that do not require closely controlled delay and delay variation. It is commonly used for "bursty" traffic typical on LANs. PCR and MBS define the burst levels, SCR defines the minimum level. An example of an VBR-nRT connection would be non-time sensitive data file transfers.

Unspecified Bit Rate (UBR)

The Unspecified Bit Rate (UBR) ATM traffic class is for bursty data transfers. However, UBR doesn't guarantee any bandwidth and only delivers traffic when the network has spare bandwidth. An example application is background file transfer.

Wireless LAN

7.1 Overview

This chapter describes how to perform tasks related to setting up and optimizing your wireless network, including the following.

- Turning the wireless connection on or off.
- Configuring a name, wireless channel and security for the network.
- Using WiFi Protected Setup (WPS) to configure your wireless network.
- Setting up multiple wireless networks.
- Using a MAC (Media Access Control) address filter to restrict access to the wireless network.
- Performing other performance-related wireless tasks.

7.1.1 What You Can Do in the Wireless LAN Screens

This section describes the AMG1312-T Series's **Network Setting > Wireless** screens. Use these screens to set up your AMG1312-T Series's wireless connection.

- Use the **General** screen to enable the Wireless LAN, enter the SSID and select the wireless security mode ([Section 7.2 on page 88](#)).
- Use the **More/Guest AP** screen (see [Section 7.3 on page 94](#)) to set up multiple wireless networks on your AMG1312-T Series and/or set up a guest wireless network on your AMG1312-T Series to allow associated wireless clients to access the Internet.
- Use the **MAC Authentication** screen to allow or deny wireless clients based on their MAC addresses from connecting to the AMG1312-T Series ([Section 7.4 on page 96](#)).
- Use the **WPS** screen (see [Section 7.5 on page 97](#)) to enable or disable WPS, generate a security PIN (Personal Identification Number) and see information about the AMG1312-T Series's WPS status.
- Use the **WDS** screen (see [Section 7.6 on page 99](#)) to set up a Wireless Distribution System, in which the AMG1312-T Series acts as a bridge with other ZyXEL access points.
- Use the **WMM** screen to enable WiFi MultiMedia (WMM) to ensure quality of service in wireless networks for multimedia applications ([Section 7.7 on page 100](#)).
- Use the **Scheduling** screen (see [Section 7.8 on page 100](#)) to configure the dates/times to enable or disable the wireless LAN.
- Use the **Advanced** screen to configure wireless advanced features ([Section 7.9 on page 101](#)).

You don't necessarily need to use all these screens to set up your wireless connection. For example, you may just want to set up a network name, a wireless radio channel and security in the **General** screen.

7.1.2 What You Need to Know About Wireless

Wireless Basics

“Wireless” is essentially radio communication. In the same way that walkie-talkie radios send and receive information over the airwaves, wireless networking devices exchange information with one another. A wireless networking device is just like a radio that lets your computer exchange information with radios attached to other computers. Like walkie-talkies, most wireless networking devices operate at radio frequency bands that are open to the public and do not require a license to use. However, wireless networking is different from that of most traditional radio communications in that there a number of wireless networking standards available with different methods of data encryption.

Finding Out More

See [Section 7.10 on page 102](#) for advanced technical information on wireless networks.

7.1.3 Before You Start

Before you start using these screens, ask yourself the following questions. See [Section 7.1.2 on page 88](#) if some of the terms used here are not familiar to you.

- What wireless standards do the other wireless devices in your network support (IEEE 802.11g, for example)? What is the most appropriate standard to use?
- What security options do the other wireless devices in your network support (WPA-PSK, for example)? What is the strongest security option supported by all the devices in your network?
- Do the other wireless devices in your network support WPS (Wi-Fi Protected Setup)? If so, you can set up a well-secured network very easily.

Even if some of your devices support WPS and some do not, you can use WPS to set up your network and then add the non-WPS devices manually, although this is somewhat more complicated to do.

- What advanced options do you want to configure, if any? If you want to configure advanced options such as Quality of Service, ensure that you know precisely what you want to do. If you do not want to configure advanced options, leave them as they are.

7.2 The General Screen

Use this screen to enable the Wireless LAN, enter the SSID and select the wireless security mode.

Note: If you are configuring the AMG1312-T Series from a computer connected to the wireless LAN and you change the AMG1312-T Series’s SSID, channel or security settings, you will lose your wireless connection when you press **Apply** to confirm. You must then change the wireless settings of your computer to match the AMG1312-T Series’s new settings.

Click **Network Setting** > **Wireless** to open the **General** screen.

Figure 27 Network Setting > Wireless > General

Wireless Network Setup

Wireless Enable Wireless LAN

Wireless Network Settings

Wireless Network Name(SSID):

Hide SSID

Client Isolation

MBSSID/LAN Isolation

Channel Selection :

Operating Channel 6

Security Level

No Security Basic **More Secure (Recommended)**

Security Mode :

Enter 8-63 characters or 64 hexadecimal digits (a-f, A-F, and 0-9).

Pre-Shared Key [more...](#)

The following table describes the labels in this screen.

Table 17 Network Setting > Wireless > General

LABEL	DESCRIPTION
Wireless Network Setup	
Wireless	Select Enable Wireless LAN to activate wireless LAN.
Wireless Network Settings	
Wireless Network Name (SSID)	The SSID (Service Set IDentity) identifies the service set with which a wireless device is associated. Wireless devices associating to the access point (AP) must have the same SSID. Enter a descriptive name (up to 32 English keyboard characters) for the wireless LAN.
Hide SSID	Select this check box to hide the SSID in the outgoing beacon frame so a station cannot obtain the SSID through scanning using a site survey tool.
Client Isolation	Select this to keep the wireless clients in this SSID from communicating with each other through the AMG1312-T Series.
MBSSID/LAN Isolation	Select this to keep the wireless clients in this SSID from communicating with clients in other SSIDs or wired LAN devices through the AMG1312-T Series. Select both Client Isolation and MBSSID/LAN Isolation to allow this SSID's wireless clients to only connect to the Internet through the AMG1312-T Series.
Channel Selection	Set the operating channel manually by selecting a channel from the Channel Selection list or use Auto to have it automatically determine a channel to use.
Operating Channel	This field displays the channel the AMG1312-T Series is currently using.
Security Level	

Table 17 Network Setting > Wireless > General (continued)

LABEL	DESCRIPTION
Security Mode	Select Basic (WEP) or More Secure (WPA(2)-PSK, WPA(2)) to add security on this wireless network. The wireless clients which want to associate to this network must have same wireless security settings as the AMG1312-T Series. When you select to use a security, additional options appears in this screen. Or you can select No Security to allow any client to associate this network without any data encryption or authentication. See the following sections for more details about this field.
Apply	Click this to save your changes.
Cancel	Click this to restore your previously saved settings.

7.2.1 No Security

Select **No Security** to allow wireless stations to communicate with the access points without any data encryption or authentication.

Note: If you do not enable any wireless security on your AMG1312-T Series, your network is accessible to any wireless networking device that is within range.

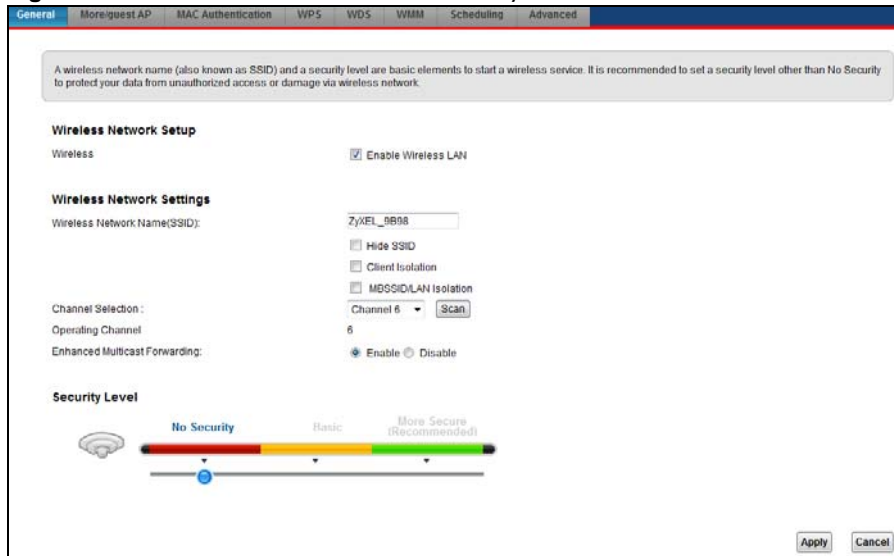
Figure 28 Wireless > General: No Security

7.2.2 Basic (WEP Encryption)

WEP encryption scrambles the data transmitted between the wireless stations and the access points (AP) to keep network communications private. Both the wireless stations and the access points must use the same WEP key.

Note: WEP is extremely insecure. Its encryption can be broken by an attacker, using widely-available software. It is strongly recommended that you use a more effective security mechanism. Use the strongest security mechanism that all the wireless devices in your network support. For example, use WPA-PSK or WPA2-PSK if all your wireless devices support it, or use WPA or WPA2 if your wireless devices support it and you have a RADIUS server. If your wireless devices support nothing stronger than WEP, use the highest encryption level available.

Your AMG1312-T Series allows you to configure one 64-bit or 128-bit WEP key.

In order to configure and enable WEP encryption, click **Network Setting > Wireless** to display the **General** screen, then select **Basic** as the security level.

Figure 29 Wireless > General: Basic (WEP)

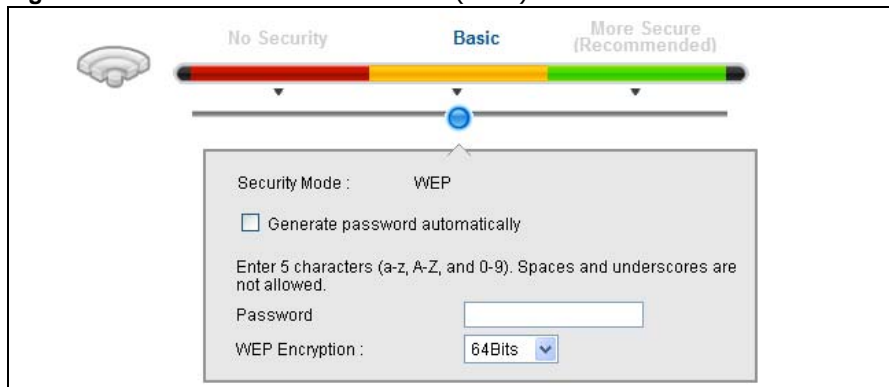

The following table describes the wireless LAN security labels in this screen.

Table 18 Wireless > General: Basic (WEP)

LABEL	DESCRIPTION
Security Level	Select Basic to enable WEP data encryption.
Generate password automatically	Select this option to have the AMG1312-T Series automatically generate a password. The password field will not be configurable when you select this option.
Password	The password (WEP key) are used to encrypt data. Both the AMG1312-T Series and the wireless stations must use the same password (WEP key) for data transmission. If you chose 64-bit WEP, then enter any 5 ASCII characters or 10 hexadecimal characters ("0-9", "A-F"). If you chose 128-bit WEP, then enter 13 ASCII characters or 26 hexadecimal characters ("0-9", "A-F").
WEP Encryption	Select 64-bits or 128-bits . This dictates the length of the security key that the network is going to use.

7.2.3 More Secure (WPA(2)-PSK)

The WPA-PSK security mode provides both improved data encryption and user authentication over WEP. Using a Pre-Shared Key (PSK), both the AMG1312-T Series and the connecting client share a common password in order to validate the connection. This type of encryption, while robust, is not as strong as WPA, WPA2 or even WPA2-PSK. The WPA2-PSK security mode is a newer, more robust version of the WPA encryption standard. It offers slightly better security, although the use of PSK makes it less robust than it could be.

Click **Network Setting > Wireless** to display the **General** screen. Select **More Secure** as the security level. Then select **WPA-PSK** or **WPA2-PSK** from the **Security Mode** list.

Figure 30 Wireless > General: More Secure: WPA(2)-PSK

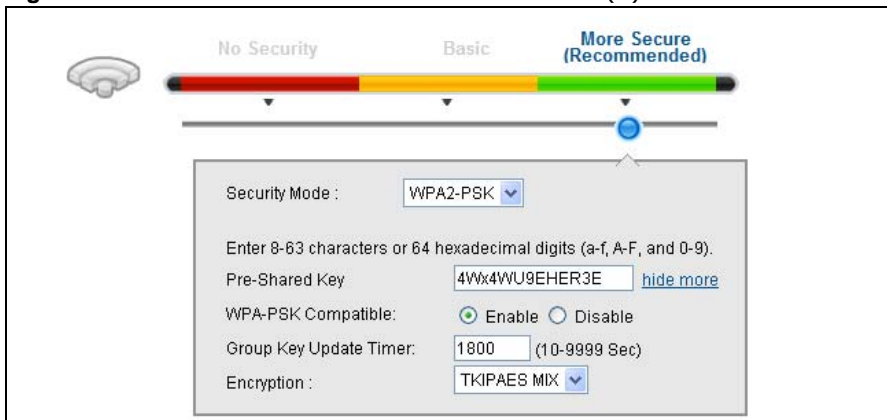

The following table describes the wireless LAN security labels in this screen.

Table 19 Wireless > General: More Secure: WPA(2)-PSK

LABEL	DESCRIPTION
Security Level	Select More Secure to enable WPA(2)-PSK data encryption.
Security Mode	Select WPA-PSK or WPA2-PSK from the drop-down list box.
Pre-Shared Key	The encryption mechanisms used for WPA(2) and WPA(2)-PSK are the same. The only difference between the two is that WPA(2)-PSK uses a simple common password, instead of user-specific credentials. Type a pre-shared key from 8 to 63 case-sensitive keyboard characters.
more.../hide more	Click more... to show more fields in this section. Click hide more to hide them.
WPA-PSK Compatible	This field appears when you choose WPA-PSK2 as the Security Mode . Select Enable to allow wireless devices using WPA-PSK security mode to connect to your AMG1312-T Series. The AMG1312-T Series supports WPA-PSK and WPA2-PSK simultaneously. Otherwise, select Disable .
Group Key Update Timer	The Group Key Update Timer is the rate at which the RADIUS server sends a new group key out to all clients.
Encryption	This field displays the encryption type for data encryption. If you choose WPA-PSK as the security mode, the AMG1312-T Series uses TKIP for data encryption. If you choose WPA2-PSK as the security mode and enable WPA-PSK Compatible, the AMG1312-T Series uses either TKIP and AES (TKIPAES MIX) for data encryption. If you choose WPA2-PSK as the security mode but disable WPA-PSK Compatible, the AMG1312-T Series uses AES for data encryption.

7.2.4 WPA(2) Authentication

The WPA2 security mode is currently the most robust form of encryption for wireless networks. It requires a RADIUS server to authenticate user credentials and is a full implementation the security protocol. Use this security option for maximum protection of your network. However, it is the least backwards compatible with older devices.

The WPA security mode is a security subset of WPA2. It requires the presence of a RADIUS server on your network in order to validate user credentials. This encryption standard is slightly older than WPA2 and therefore is more compatible with older devices.

Click **Network Setting > Wireless** to display the **General** screen. Select **More Secure** as the security level. Then select **WPA** or **WPA2** from the **Security Mode** list.

Figure 31 Wireless > General: More Secure: WPA(2)

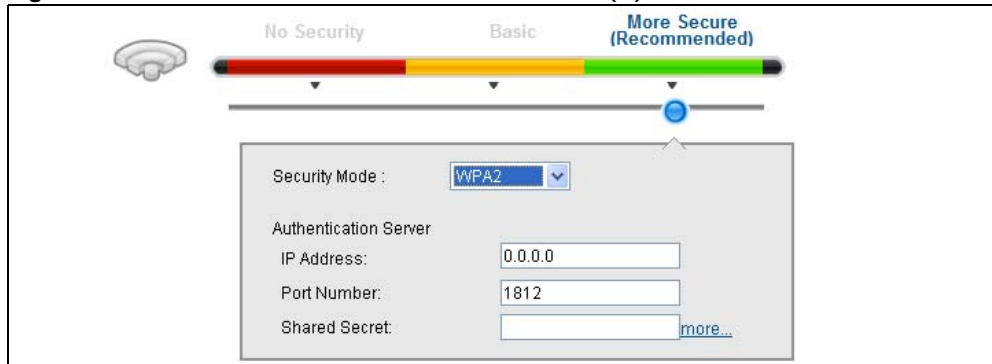

The following table describes the labels in this screen.

Table 20 Wireless > General: More Secure: WPA(2)

LABEL	DESCRIPTION
Security Level	Select More Secure to enable WPA(2) data encryption.
Security Mode	Choose WPA or WPA2 from the drop-down list box.
Authentication Server	
IP Address	Enter the IP address of the external authentication server in dotted decimal notation.
Port Number	Enter the port number of the external authentication server. You need not change this value unless your network administrator instructs you to do so with additional information.
Shared Secret	Enter a password (up to 31 alphanumeric characters) as the key to be shared between the external authentication server and the AMG1312-T Series. The key must be the same on the external authentication server and your AMG1312-T Series. The key is not sent over the network.
more.../hide more	Click more... to show more fields in this section. Click hide more to hide them.
ReAuthentication Timer	Enter how often the external authentication server requires a connected wireless client to reauthenticate itself to the server again.
Network Re-auth Interval	Specify how often wireless stations have to resend user names and passwords in order to stay connected. This field is available only when you select WPA2 as security mode. If wireless station authentication is done using a RADIUS server, the reauthentication timer on the RADIUS server has priority.
WPA Compatible	This field is only available for WPA2. Select this if you want the AMG1312-T Series to support WPA and WPA2 simultaneously.

Table 20 Wireless > General: More Secure: WPA(2) (continued)

LABEL	DESCRIPTION
Group Key Update Timer	The Group Key Update Timer is the rate at which the RADIUS server sends a new group key out to all clients.
Encryption	Select the encryption type for data encryption. If you choose WPA as the security mode, the AMG1312-T Series uses TKIP for data encryption. If you choose WPA2 as the security mode and enable WPA-PSK Compatible, the AMG1312-T Series uses either TKIP and AES (TKIPAES MIX) for data encryption. If you choose WPA2 as the security mode but disable WPA-PSK Compatible, the AMG1312-T Series uses AES for data encryption.

7.3 The More/Guest AP Screen

This screen allows you to enable and configure multiple Basic Service Sets (BSSs) on the AMG1312-T Series.

Click **Network Setting > Wireless > More/guest AP**. The following screen displays.

Figure 32 Network Setting > Wireless > More/guest AP

#	Active	SSID	Security	Modify
1		N/A	N/A	
2		N/A	N/A	
3		N/A	N/A	

The following table describes the labels in this screen.

Table 21 Network Setting > Wireless > More/guest AP

LABEL	DESCRIPTION
#	This is the index number of each SSID profile.
Active	This field indicates whether this SSID is active. A yellow bulb signifies that this SSID is active. A gray bulb signifies that this SSID is not active.
SSID	An SSID profile is the set of parameters relating to one of the AMG1312-T Series's BSSs. The SSID (Service Set IDentifier) identifies the Service Set with which a wireless device is associated. This field displays the name of the wireless profile on the network. When a wireless client scans for an AP to associate with, this is the name that is broadcast and seen in the wireless client utility.
Security	This field indicates the security mode of the SSID profile.
Modify	Click the Edit icon to configure the SSID profile.

7.3.1 More AP Edit

Use this screen to edit an SSID profile. Click the **Edit** icon next to an SSID in the **More AP** screen. The following screen displays.

Figure 33 More AP: Edit

The following table describes the fields in this screen.

Table 22 More AP: Edit

LABEL	DESCRIPTION
Wireless Network Setup	
Wireless	Select Enable Wireless LAN to activate wireless LAN.
Wireless Network Settings	
Wireless Network Name (SSID)	The SSID (Service Set IDentity) identifies the service set with which a wireless device is associated. Wireless devices associating to the access point (AP) must have the same SSID. Enter a descriptive name (up to 32 English keyboard characters) for the wireless LAN.
Hide SSID	Select this check box to hide the SSID in the outgoing beacon frame so a station cannot obtain the SSID through scanning using a site survey tool.
Guest WLAN	Select this check box to enable and configure the guest wireless network.
Security Level	
Security Mode	Select Basic (WEP) or More Secure (WPA(2)-PSK, WPA(2)) to add security on this wireless network. The wireless clients which want to associate to this network must have same wireless security settings as the AMG1312-T Series. After you select to use a security, additional options appears in this screen. Or you can select No Security to allow any client to associate this network without any data encryption or authentication.
OK	Click OK to save your changes.
Cancel	Click Cancel to exit this screen without saving.

7.4 The MAC Authentication Screen

This screen allows you to configure the AMG1312-T Series to give exclusive access to specific devices (**Allow**) or exclude specific devices from accessing the AMG1312-T Series (**Deny**). Every Ethernet device has a unique MAC (Media Access Control) address. The MAC address is assigned at the factory and consists of six pairs of hexadecimal characters, for example, 00:A0:C5:00:00:02. You need to know the MAC addresses of the devices to configure this screen.

Use this screen to view your AMG1312-T Series's MAC filter settings and add new MAC filter rules. Click **Network Setting > Wireless > MAC Authentication**. The screen appears as shown.

Figure 34 Network Setting > Wireless > MAC Authentication

The following table describes the labels in this screen.

Table 23 Network Setting > Wireless > MAC Authentication

LABEL	DESCRIPTION
SSID	Select the SSID for which you want to configure MAC filter settings.
MAC List	Define the filter action for the list of MAC addresses in the MAC Address table. Select Disable to turn off MAC filtering. Select Allow to permit access to the AMG1312-T Series. MAC addresses not listed will be denied access to the AMG1312-T Series. Select Deny to block access to the AMG1312-T Series. MAC addresses not listed will be allowed to access the AMG1312-T Series.
Add new MAC address	Click this if you want to add a new MAC address entry to the MAC filter list below. Enter the MAC addresses of the wireless devices that are allowed or denied access to the AMG1312-T Series in these address fields. Enter the MAC addresses in a valid MAC address format, that is, six hexadecimal character pairs, for example, 12:34:56:78:9a:bc.
#	This is the index number of the entry.
MAC Address	This is the MAC addresses of the wireless devices that are allowed or denied access to the AMG1312-T Series.
Modify	Click the Delete icon to delete the entry.
Apply	Click Apply to save your changes.
Cancel	Click Cancel to exit this screen without saving.

7.5 The WPS Screen

Use this screen to configure WiFi Protected Setup (WPS) on your AMG1312-T Series.

WPS allows you to quickly set up a wireless network with strong security, without having to configure security settings manually. Set up each WPS connection between two devices. Both devices must support WPS. See [Section 7.10.8.3 on page 110](#) for more information about WPS.

Note: The AMG1312-T Series applies the security settings configured in the General screen (see [Section 7.2 on page 88](#)). If you want to use the WPS feature, make sure you have set the security mode to **WPA-PSK**, **WPA2-PSK** or **No Security**.

Click **Network Setting > Wireless > WPS**. The following screen displays. Select **Enable** and click **Apply** to activate the WPS function. Then you can configure the WPS settings in this screen.

Figure 35 Network Setting > Wireless > WPS

General

WPS: Enable Disable (settings are invalid when disabled)

Add a new device with WPS Method

Method 1 PBC

Step 1. Click WPS button

Step 2. Press the WPS button on your new wireless client device within 120 seconds

Method 2 PIN

Step 1. Enter the PIN of your new wireless client device and then click Register

Step 2. Press the WPS button on your new wireless client device within 120 seconds

WPS Configuration Summary

AP PIN: 08186324

Status: Unconfigured

Lock Status: Unlocked

802.11 Mode: 802.11b+g+n

SSID: ZyXEL_7DC8

Security: WPA-PSKWPA2-PSK

Pre-Shared Key: 4Wx4WU9EHER3E

Note:

- If you enable WPS, it will turned on UPnP service automatically.
- This feature is available only when WPA2-PSK, WPA-PSKWPA2-PSK or No Security mode is configured.

The following table describes the labels in this screen.

Table 24 Network Setting > Wireless > WPS

LABEL	DESCRIPTION
General	
WPS	Select Enable to activate WPS on the AMG1312-T Series. Otherwise, select Disable to deactivate WPS.

Table 24 Network Setting > Wireless > WPS (continued)

LABEL	DESCRIPTION
Add a new device with WPS Method	
Method 1 PBC	Use this section to set up a WPS wireless network using Push Button Configuration (PBC).
WPS	<p>Click this button to add another WPS-enabled wireless device (within wireless range of the AMG1312-T Series) to your wireless network. This button may either be a physical button on the outside of device, or a menu button similar to the WPS button on this screen.</p> <p>Note: You must press the other wireless device's WPS button within two minutes of pressing this button.</p>
Method 2 PIN	Use this section to set up a WPS wireless network by entering the PIN of the client into the AMG1312-T Series.
Register	<p>Enter the PIN of the device that you are setting up a WPS connection with and click Register to authenticate and add the wireless device to your wireless network.</p> <p>You can find the PIN either on the outside of the device, or by checking the device's settings.</p> <p>Note: You must also activate WPS on that device within two minutes to have it present its PIN to the AMG1312-T Series.</p>
WPS Configuration Summary	
AP PIN	<p>The PIN (Personal Identification Number) of the AMG1312-T Series is shown here. Enter this PIN in the configuration utility of the device you want to connect to using WPS.</p> <p>The PIN is not necessary when you use WPS push-button method.</p> <p>Click the Generate New PIN button to have the AMG1312-T Series create a new PIN.</p>
Status	<p>This displays Configured when the AMG1312-T Series has connected to a wireless network using WPS or Enable WPS is selected and wireless or wireless security settings have been changed. The current wireless and wireless security settings also appear in the screen.</p> <p>This displays Unconfigured if WPS is disabled and there is no wireless or wireless security changes on the AMG1312-T Series or you click Release to remove the configured wireless and wireless security settings.</p>
Release Configuration	<p>The default WPS status is Configured.</p> <p>Click this button to remove all configured wireless and wireless security settings for WPS connections on the AMG1312-T Series.</p>
802.11 Mode	This field displays the AMG1312-T Series's wireless mode that only allows the compliant WLAN devices to associate with it.
SSID	This field displays the SSID the AMG1312-T Series is currently using.
Security	This field displays the security mode the AMG1312-T Series is currently using.
Pre-Shared Key	This field displays the pre-shared key the AMG1312-T Series uses when the security mode is set to WPA(2)-PSK.
Apply	Click this to save your changes.
Cancel	Click this to restore your previously saved settings.

7.6 The WDS Screen

An AP using the Wireless Distribution System (WDS) can function as a wireless network bridge allowing you to wirelessly connect wired network segments. The **WDS** screen allows you to configure the AMG1312-T Series to connect to other APs wirelessly when WDS is enabled.

Use this screen to set up your WDS (Wireless Distribution System) links between the AMG1312-T Series and other wireless APs. You need to know the MAC address of the peer device. Once the security settings of peer sides match one another, the connection between devices is made.

Note: WDS security is independent of the security settings between the AMG1312-T Series and any wireless clients.

Note: At the time of writing, WDS is compatible with other ZyXEL APs only. Not all models support WDS links. Check your other AP's documentation.

Click **Network Setting > Wireless > WDS**. The following screen displays.

Figure 36 Network Setting > Wireless > WDS

#	Active	Remote Bridge MAC Address	PSK
1	<input type="checkbox"/>	00:00:00:00:00:00	
2	<input type="checkbox"/>	00:00:00:00:00:00	
3	<input type="checkbox"/>	00:00:00:00:00:00	
4	<input type="checkbox"/>	00:00:00:00:00:00	

The following table describes the labels in this screen.

Table 25 Network Setting > Wireless > WDS

LABEL	DESCRIPTION
WDS Security	Select the type of the key used to encrypt data between APs. All the wireless APs (including the AMG1312-T Series) must use the same pre-shared key for data transmission. The option is available only when you set the security mode to WPA(2) or WPA(2)-PSK in the Wireless > General screen.
TKIP	Select this to use TKIP (Temporal Key Integrity Protocol) encryption.
AES	Select this to use AES (Advanced Encryption Standard) encryption.
#	This is the index number of the individual WDS link.
Active	Select this to activate the link between the AMG1312-T Series and the peer device to which this entry refers. When you do not select the check box this link is down.
Remote Bridge MAC Address	Type the MAC address of the peer device in a valid MAC address format (six hexadecimal character pairs, for example 12:34:56:78:9a:bc).
PSK	Enter a Pre-Shared Key (PSK) from 8 to 63 case-sensitive ASCII characters (including spaces and symbols).
Apply	Click this to save your changes.
Cancel	Click this to restore your previously saved settings.

7.7 The WMM Screen

Use this screen to enable WiFi MultiMedia (WMM) and WMM Power Save in wireless networks for multimedia applications.

Click **Network Setting** > **Wireless** > **WMM**. The following screen displays.

Figure 37 Network Setting > Wireless > WMM

The following table describes the labels in this screen.

Table 26 Network Setting > Wireless > WMM

LABEL	DESCRIPTION
Enable WMM of SSID1~4	Use the checkboxes to determine whether to have the AMG1312-T Series automatically give a service a priority level according to the ToS value in the IP header of packets it sends for a wireless network. WMM QoS (WiFi MultiMedia Quality of Service) gives high priority to voice and video, which makes them run more smoothly.
Apply	Click Apply to save your changes.
Cancel	Click Cancel to restore your previously saved settings.

7.8 The Scheduling Screen

Use the wireless LAN scheduling to configure the days you want to enable or disable the wireless LAN. Click **Network Setting** > **Wireless** > **Scheduling**. The following screen displays.

Figure 38 Network Setting > Wireless > Scheduling

The following table describes the labels in this screen.

Table 27 Network Setting > Wireless > Scheduling

LABEL	DESCRIPTION
Wireless LAN Scheduling	Select Enable or Disable to activate or deactivate wireless LAN scheduling on your AMG1312-T Series.
State	Select On or Off to enable or disable the wireless LAN.
Day	Check the day(s) you want to turn the wireless LAN on or off.
Time (24-Hour Format)	Specify a time frame during which the schedule would apply. For example, if you set the time range from 12:00 to 23:00, the wireless LAN will be turned on only during this time period.
Apply	Click this to save your changes.
Cancel	Click this to restore your previously saved settings.

7.9 The Advanced Screen

Use this screen to configure advanced wireless settings. Click **Network Setting > Wireless > Advanced**, the screen appears as shown.

See [Section 7.10.2 on page 104](#) for detailed definitions of the terms listed in this screen.

Figure 39 Network Setting > Wireless> Advanced

Fragmentation Threshold: (256 ~ 2346, even numbers only)

Output Power:

Preamble:

802.11 Mode:

Channel Width:

The following table describes the labels in this screen.

Table 28 Network Setting > Wireless> Advanced

LABEL	DESCRIPTION
Fragmentation Threshold	This is the maximum data fragment size that can be sent. Enter a value between 256 and 2346.
Output Power	Set the output power of the AMG1312-T Series. If there is a high density of APs in an area, decrease the output power to reduce interference with other APs. Select one of the following: 100% , 75% , 50% or 25% .
Preamble	Select a preamble type from the drop-down list menu. Choices are Long or Short . See the Appendix D on page 268 for more information.

Table 28 Network Setting > Wireless> Advanced (continued)

LABEL	DESCRIPTION
802.11 Mode	<p>Select 802.11b Only to allow only IEEE 802.11b compliant WLAN devices to associate with the AMG1312-T Series.</p> <p>Select 802.11g Only to allow only IEEE 802.11g compliant WLAN devices to associate with the AMG1312-T Series.</p> <p>Select 802.11b+g to allow either IEEE 802.11b or IEEE 802.11g compliant WLAN devices to associate with the AMG1312-T Series. The transmission rate of your AMG1312-T Series might be reduced.</p> <p>Select 802.11n to allow only IEEE 802.11n compliant WLAN devices to associate with the AMG1312-T Series.</p> <p>Select 802.11g+n to allow either IEEE 802.11g or IEEE 802.11n compliant WLAN devices to associate with the AMG1312-T Series. The transmission rate of your AMG1312-T Series might be reduced.</p> <p>Select 802.11b+g+n to allow IEEE 802.11b, IEEE 802.11g or IEEE802.11n compliant WLAN devices to associate with the AMG1312-T Series. The transmission rate of your AMG1312-T Series might be reduced.</p>
Channel Width	<p>Select whether the AMG1312-T Series uses a wireless channel width of 20MHz or Auto. If Auto is selected, the AMG1312-T Series will use 40MHz if it is supported.</p> <p>A standard 20MHz channel offers transfer speeds of up to 150Mbps whereas a 40MHz channel uses two standard channels and offers speeds of up to 300 Mbps.</p> <p>40MHz (channel bonding or dual channel) bonds two adjacent radio channels to increase throughput. The wireless clients must also support 40 MHz. It is often better to use the 20 MHz setting in a location where the environment hinders the wireless signal.</p> <p>Select 20MHz if you want to lessen radio interference with other wireless devices in your neighborhood or the wireless clients do not support channel bonding.</p> <p>This field is available only when you set the 802.11 Mode to 802.11n or 802.11b+g+n in the Advanced Setup screen.</p>
Apply	Click this to save your changes.
Cancel	Click this to restore your previously saved settings.

7.10 Wireless LAN Technical Reference

This section discusses wireless LANs in depth. For more information, see the appendix.

7.10.1 Wireless Network Overview

Wireless networks consist of wireless clients, access points and bridges.

- A wireless client is a radio connected to a user's computer.
- An access point is a radio with a wired connection to a network, which can connect with numerous wireless clients and let them access the network.
- A bridge is a radio that relays communications between access points and wireless clients, extending a network's range.

Traditionally, a wireless network operates in one of two ways.

- An “infrastructure” type of network has one or more access points and one or more wireless clients. The wireless clients connect to the access points.
- An “ad-hoc” type of network is one in which there is no access point. Wireless clients connect to one another in order to exchange information.

The following figure provides an example of a wireless network.

Figure 40 Example of a Wireless Network

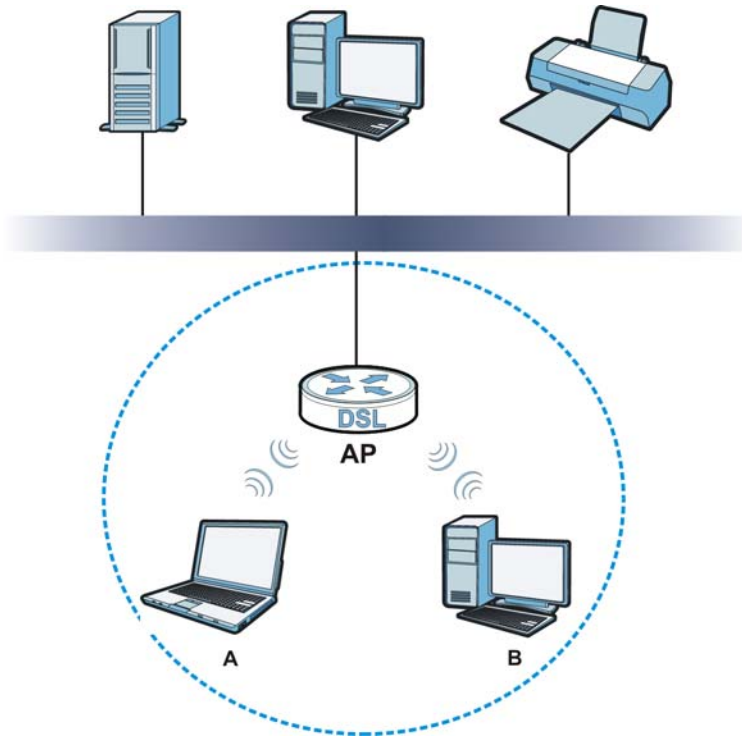

The wireless network is the part in the blue circle. In this wireless network, devices **A** and **B** use the access point (**AP**) to interact with the other devices (such as the printer) or with the Internet. Your AMG1312-T Series is the AP.

Every wireless network must follow these basic guidelines.

- Every device in the same wireless network must use the same SSID.
The SSID is the name of the wireless network. It stands for Service Set IDentifier.
- If two wireless networks overlap, they should use a different channel.
Like radio stations or television channels, each wireless network uses a specific channel, or frequency, to send and receive information.
- Every device in the same wireless network must use security compatible with the AP.
Security stops unauthorized devices from using the wireless network. It can also protect the information that is sent in the wireless network.

Radio Channels

In the radio spectrum, there are certain frequency bands allocated for unlicensed, civilian use. For the purposes of wireless networking, these bands are divided into numerous channels. This allows a

variety of networks to exist in the same place without interfering with one another. When you create a network, you must select a channel to use.

Since the available unlicensed spectrum varies from one country to another, the number of available channels also varies.

7.10.2 Additional Wireless Terms

The following table describes some wireless network terms and acronyms used in the AMG1312-T Series's Web Configurator.

Table 29 Additional Wireless Terms

TERM	DESCRIPTION
Preamble	A preamble affects the timing in your wireless network. There are two preamble modes: long and short. If a device uses a different preamble mode than the AMG1312-T Series does, it cannot communicate with the AMG1312-T Series.
Authentication	The process of verifying whether a wireless device is allowed to use the wireless network.
Fragmentation Threshold	A small fragmentation threshold is recommended for busy networks, while a larger threshold provides faster performance if the network is not very busy.

7.10.3 Wireless Security Overview

By their nature, radio communications are simple to intercept. For wireless data networks, this means that anyone within range of a wireless network without security can not only read the data passing over the airwaves, but also join the network. Once an unauthorized person has access to the network, he or she can steal information or introduce malware (malicious software) intended to compromise the network. For these reasons, a variety of security systems have been developed to ensure that only authorized people can use a wireless data network, or understand the data carried on it.

These security standards do two things. First, they authenticate. This means that only people presenting the right credentials (often a username and password, or a "key" phrase) can access the network. Second, they encrypt. This means that the information sent over the air is encoded. Only people with the code key can understand the information, and only people who have been authenticated are given the code key.

These security standards vary in effectiveness. Some can be broken, such as the old Wired Equivalent Protocol (WEP). Using WEP is better than using no security at all, but it will not keep a determined attacker out. Other security standards are secure in themselves but can be broken if a user does not use them properly. For example, the WPA-PSK security standard is very secure if you use a long key which is difficult for an attacker's software to guess - for example, a twenty-letter long string of apparently random numbers and letters - but it is not very secure if you use a short key which is very easy to guess - for example, a three-letter word from the dictionary.

Because of the damage that can be done by a malicious attacker, it's not just people who have sensitive information on their network who should use security. Everybody who uses any wireless network should ensure that effective security is in place.

A good way to come up with effective security keys, passwords and so on is to use obscure information that you personally will easily remember, and to enter it in a way that appears random and does not include real words. For example, if your mother owns a 1970 Dodge Challenger and

her favorite movie is Vanishing Point (which you know was made in 1971) you could use "70dodchal71vanpoi" as your security key.

The following sections introduce different types of wireless security you can set up in the wireless network.

7.10.3.1 SSID

Normally, the AMG1312-T Series acts like a beacon and regularly broadcasts the SSID in the area. You can hide the SSID instead, in which case the AMG1312-T Series does not broadcast the SSID. In addition, you should change the default SSID to something that is difficult to guess.

This type of security is fairly weak, however, because there are ways for unauthorized wireless devices to get the SSID. In addition, unauthorized wireless devices can still see the information that is sent in the wireless network.

7.10.3.2 MAC Address Filter

Every device that can use a wireless network has a unique identification number, called a MAC address.¹ A MAC address is usually written using twelve hexadecimal characters²; for example, 00A0C5000002 or 00:A0:C5:00:00:02. To get the MAC address for each device in the wireless network, see the device's User's Guide or other documentation.

You can use the MAC address filter to tell the AMG1312-T Series which devices are allowed or not allowed to use the wireless network. If a device is allowed to use the wireless network, it still has to have the correct information (SSID, channel, and security). If a device is not allowed to use the wireless network, it does not matter if it has the correct information.

This type of security does not protect the information that is sent in the wireless network. Furthermore, there are ways for unauthorized wireless devices to get the MAC address of an authorized device. Then, they can use that MAC address to use the wireless network.

7.10.3.3 User Authentication

Authentication is the process of verifying whether a wireless device is allowed to use the wireless network. You can make every user log in to the wireless network before using it. However, every device in the wireless network has to support IEEE 802.1x to do this.

For wireless networks, you can store the user names and passwords for each user in a RADIUS server. This is a server used in businesses more than in homes. If you do not have a RADIUS server, you cannot set up user names and passwords for your users.

Unauthorized wireless devices can still see the information that is sent in the wireless network, even if they cannot use the wireless network. Furthermore, there are ways for unauthorized wireless users to get a valid user name and password. Then, they can use that user name and password to use the wireless network.

-
1. Some wireless devices, such as scanners, can detect wireless networks but cannot use wireless networks. These kinds of wireless devices might not have MAC addresses.
 2. Hexadecimal characters are 0, 1, 2, 3, 4, 5, 6, 7, 8, 9, A, B, C, D, E, and F.

7.10.3.4 Encryption

Wireless networks can use encryption to protect the information that is sent in the wireless network. Encryption is like a secret code. If you do not know the secret code, you cannot understand the message.

The types of encryption you can choose depend on the type of authentication. (See [Section 7.10.3.3 on page 105](#) for information about this.)

Table 30 Types of Encryption for Each Type of Authentication

	NO AUTHENTICATION	RADIUS SERVER
Weakest ↕	No Security	WPA
	Static WEP	
	WPA-PSK	
Strongest	WPA2-PSK	WPA2

For example, if the wireless network has a RADIUS server, you can choose **WPA** or **WPA2**. If users do not log in to the wireless network, you can choose no encryption, **Static WEP**, **WPA-PSK**, or **WPA2-PSK**.

Usually, you should set up the strongest encryption that every device in the wireless network supports. For example, suppose you have a wireless network with the AMG1312-T Series and you do not have a RADIUS server. Therefore, there is no authentication. Suppose the wireless network has two devices. Device A only supports WEP, and device B supports WEP and WPA-PSK. Therefore, you should set up **Static WEP** in the wireless network.

Note: It is recommended that wireless networks use **WPA-PSK**, **WPA**, or stronger encryption. The other types of encryption are better than none at all, but it is still possible for unauthorized wireless devices to figure out the original information pretty quickly.

When you select **WPA2** or **WPA2-PSK** in your AMG1312-T Series, you can also select an option (**WPA compatible**) to support WPA as well. In this case, if some of the devices support WPA and some support WPA2, you should set up **WPA2-PSK** or **WPA2** (depending on the type of wireless network login) and select the **WPA compatible** option in the AMG1312-T Series.

Many types of encryption use a key to protect the information in the wireless network. The longer the key, the stronger the encryption. Every device in the wireless network must have the same key.

7.10.4 Signal Problems

Because wireless networks are radio networks, their signals are subject to limitations of distance, interference and absorption.

Problems with distance occur when the two radios are too far apart. Problems with interference occur when other radio waves interrupt the data signal. Interference may come from other radio transmissions, such as military or air traffic control communications, or from machines that are coincidental emitters such as electric motors or microwaves. Problems with absorption occur when physical objects (such as thick walls) are between the two radios, muffling the signal.

7.10.5 BSS

A Basic Service Set (BSS) exists when all communications between wireless stations or between a wireless station and a wired network client go through one access point (AP).

Intra-BSS traffic is traffic between wireless stations in the BSS. When Intra-BSS traffic blocking is disabled, wireless station A and B can access the wired network and communicate with each other. When Intra-BSS traffic blocking is enabled, wireless station A and B can still access the wired network but cannot communicate with each other.

Figure 41 Basic Service set

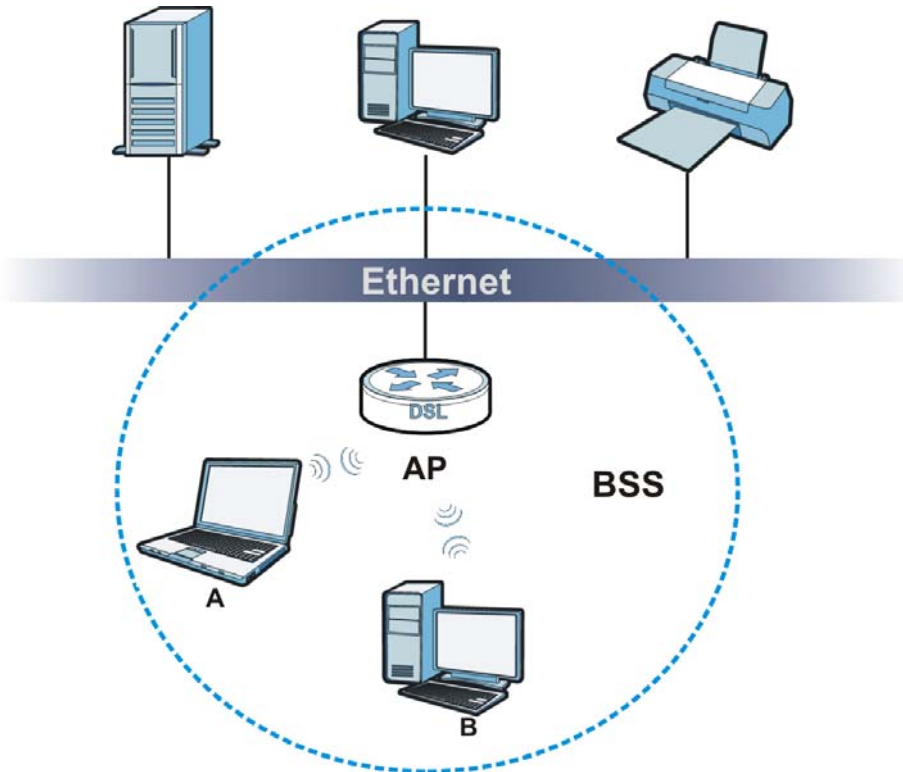

7.10.6 MBSSID

Traditionally, you need to use different APs to configure different Basic Service Sets (BSSs). As well as the cost of buying extra APs, there is also the possibility of channel interference. The AMG1312-T Series's MBSSID (Multiple Basic Service Set Identifier) function allows you to use one access point to provide several BSSs simultaneously. You can then assign varying QoS priorities and/or security modes to different SSIDs.

Wireless devices can use different BSSIDs to associate with the same AP.

7.10.6.1 Notes on Multiple BSSs

- A maximum of eight BSSs are allowed on one AP simultaneously.
- You must use different keys for different BSSs. If two wireless devices have different BSSIDs (they are in different BSSs), but have the same keys, they may hear each other's communications (but not communicate with each other).

- MBSSID should not replace but rather be used in conjunction with 802.1x security.

7.10.7 Wireless Distribution System (WDS)

The AMG1312-T Series can act as a wireless network bridge and establish WDS (Wireless Distribution System) links with other APs. You need to know the MAC addresses of the APs you want to link to. Once the security settings of peer sides match one another, the connection between devices is made.

At the time of writing, WDS security is compatible with other ZyXEL access points only. Refer to your other access point's documentation for details.

The following figure illustrates how WDS link works between APs. Notebook computer **A** is a wireless client connecting to access point **AP 1**. **AP 1** has no wired Internet connection, but it can establish a WDS link with access point **AP 2**, which has a wired Internet connection. When **AP 1** has a WDS link with **AP 2**, the notebook computer can access the Internet through **AP 2**.

Figure 42 WDS Link Example



7.10.8 WiFi Protected Setup (WPS)

Your AMG1312-T Series supports WiFi Protected Setup (WPS), which is an easy way to set up a secure wireless network. WPS is an industry standard specification, defined by the WiFi Alliance.

WPS allows you to quickly set up a wireless network with strong security, without having to configure security settings manually. Each WPS connection works between two devices. Both devices must support WPS (check each device's documentation to make sure).

Depending on the devices you have, you can either press a button (on the device itself, or in its configuration utility) or enter a PIN (a unique Personal Identification Number that allows one device to authenticate the other) in each of the two devices. When WPS is activated on a device, it has two minutes to find another device that also has WPS activated. Then, the two devices connect and set up a secure network by themselves.

7.10.8.1 Push Button Configuration

WPS Push Button Configuration (PBC) is initiated by pressing a button on each WPS-enabled device, and allowing them to connect automatically. You do not need to enter any information.

Not every WPS-enabled device has a physical WPS button. Some may have a WPS PBC button in their configuration utilities instead of or in addition to the physical button.

Take the following steps to set up WPS using the button.

- 1 Ensure that the two devices you want to set up are within wireless range of one another.

- 2 Look for a WPS button on each device. If the device does not have one, log into its configuration utility and locate the button (see the device's User's Guide for how to do this - for the AMG1312-T Series, see [Section 7.6 on page 99](#)).
- 3 Press the button on one of the devices (it doesn't matter which). For the AMG1312-T Series you must press the WPS button for more than three seconds.
- 4 Within two minutes, press the button on the other device. The registrar sends the network name (SSID) and security key through an secure connection to the enrollee.

If you need to make sure that WPS worked, check the list of associated wireless clients in the AP's configuration utility. If you see the wireless client in the list, WPS was successful.

7.10.8.2 PIN Configuration

Each WPS-enabled device has its own PIN (Personal Identification Number). This may either be static (it cannot be changed) or dynamic (in some devices you can generate a new PIN by clicking on a button in the configuration interface).

Use the PIN method instead of the push-button configuration (PBC) method if you want to ensure that the connection is established between the devices you specify, not just the first two devices to activate WPS in range of each other. However, you need to log into the configuration interfaces of both devices to use the PIN method.

When you use the PIN method, you must enter the PIN from one device (usually the wireless client) into the second device (usually the Access Point or wireless router). Then, when WPS is activated on the first device, it presents its PIN to the second device. If the PIN matches, one device sends the network and security information to the other, allowing it to join the network.

Take the following steps to set up a WPS connection between an access point or wireless router (referred to here as the AP) and a client device using the PIN method.

- 1 Ensure WPS is enabled on both devices.
- 2 Access the WPS section of the AP's configuration interface. See the device's User's Guide for how to do this.
- 3 Look for the client's WPS PIN; it will be displayed either on the device, or in the WPS section of the client's configuration interface (see the device's User's Guide for how to find the WPS PIN - for the AMG1312-T Series, see [Section 7.5 on page 97](#)).
- 4 Enter the client's PIN in the AP's configuration interface.
- 5 If the client device's configuration interface has an area for entering another device's PIN, you can either enter the client's PIN in the AP, or enter the AP's PIN in the client - it does not matter which.
- 6 Start WPS on both devices within two minutes.
- 7 Use the configuration utility to activate WPS, not the push-button on the device itself.
- 8 On a computer connected to the wireless client, try to connect to the Internet. If you can connect, WPS was successful.

If you cannot connect, check the list of associated wireless clients in the AP's configuration utility. If you see the wireless client in the list, WPS was successful.

The following figure shows a WPS-enabled wireless client (installed in a notebook computer) connecting to the WPS-enabled AP via the PIN method.

Figure 43 Example WPS Process: PIN Method

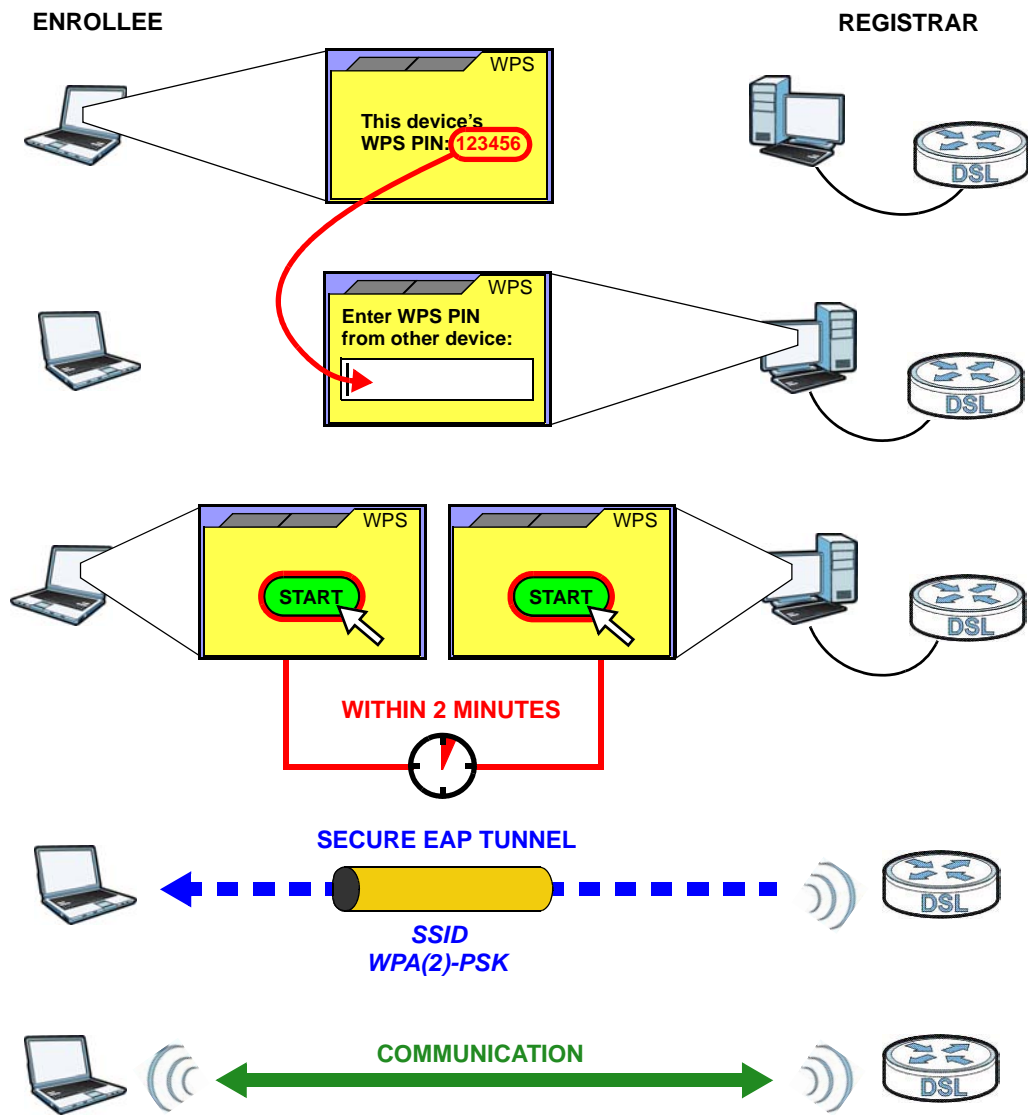

7.10.8.3 How WPS Works

When two WPS-enabled devices connect, each device must assume a specific role. One device acts as the registrar (the device that supplies network and security settings) and the other device acts as the enrollee (the device that receives network and security settings). The registrar creates a secure EAP (Extensible Authentication Protocol) tunnel and sends the network name (SSID) and the WPA-PSK or WPA2-PSK pre-shared key to the enrollee. Whether WPA-PSK or WPA2-PSK is used depends on the standards supported by the devices. If the registrar is already part of a network, it sends the existing information. If not, it generates the SSID and WPA(2)-PSK randomly.

The following figure shows a WPS-enabled client (installed in a notebook computer) connecting to a WPS-enabled access point.

Figure 44 How WPS works

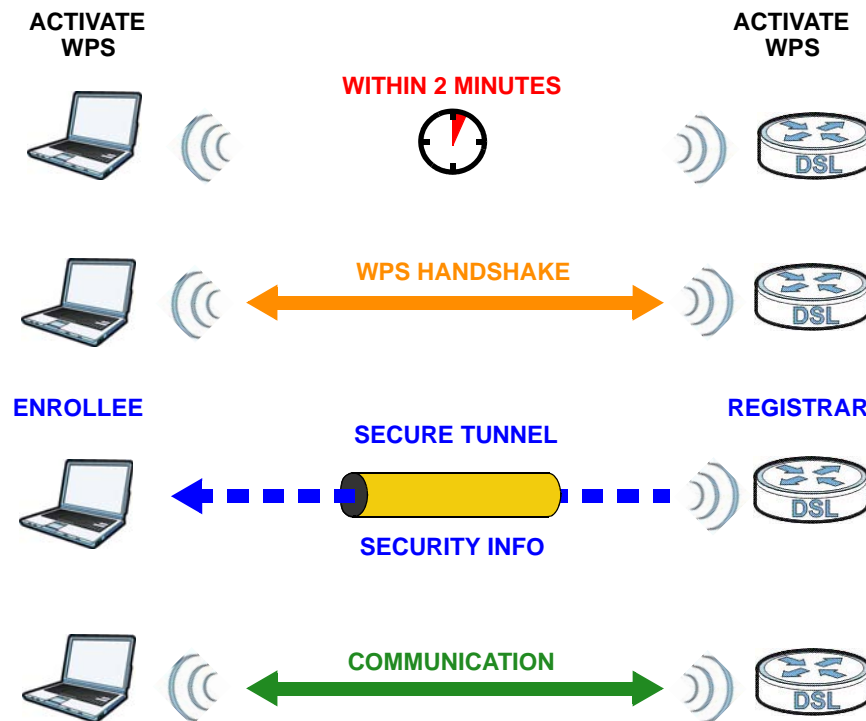

The roles of registrar and enrollee last only as long as the WPS setup process is active (two minutes). The next time you use WPS, a different device can be the registrar if necessary.

The WPS connection process is like a handshake; only two devices participate in each WPS transaction. If you want to add more devices you should repeat the process with one of the existing networked devices and the new device.

Note that the access point (AP) is not always the registrar, and the wireless client is not always the enrollee. All WPS-certified APs can be a registrar, and so can some WPS-enabled wireless clients.

By default, a WPS device is “unconfigured”. This means that it is not part of an existing network and can act as either enrollee or registrar (if it supports both functions). If the registrar is unconfigured, the security settings it transmits to the enrollee are randomly-generated. Once a WPS-enabled device has connected to another device using WPS, it becomes “configured”. A configured wireless client can still act as enrollee or registrar in subsequent WPS connections, but a configured access point can no longer act as enrollee. It will be the registrar in all subsequent WPS connections in which it is involved. If you want a configured AP to act as an enrollee, you must reset it to its factory defaults.

7.10.8.4 Example WPS Network Setup

This section shows how security settings are distributed in an example WPS setup.

The following figure shows an example network. In step 1, both **AP1** and **Client 1** are unconfigured. When WPS is activated on both, they perform the handshake. In this example, **AP1** is the registrar, and **Client 1** is the enrollee. The registrar randomly generates the security information to set up the network, since it is unconfigured and has no existing information.

Figure 45 WPS: Example Network Step 1

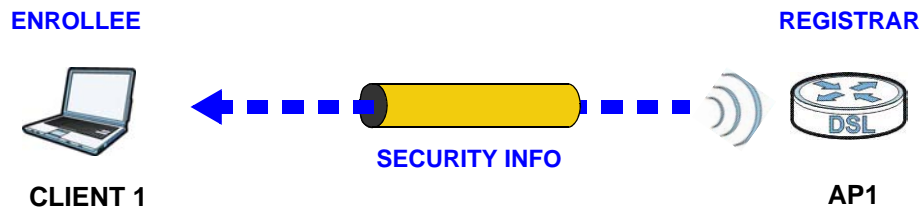

In step 2, you add another wireless client to the network. You know that **Client 1** supports registrar mode, but it is better to use **AP1** for the WPS handshake with the new client since you must connect to the access point anyway in order to use the network. In this case, **AP1** must be the registrar, since it is configured (it already has security information for the network). **AP1** supplies the existing security information to **Client 2**.

Figure 46 WPS: Example Network Step 2

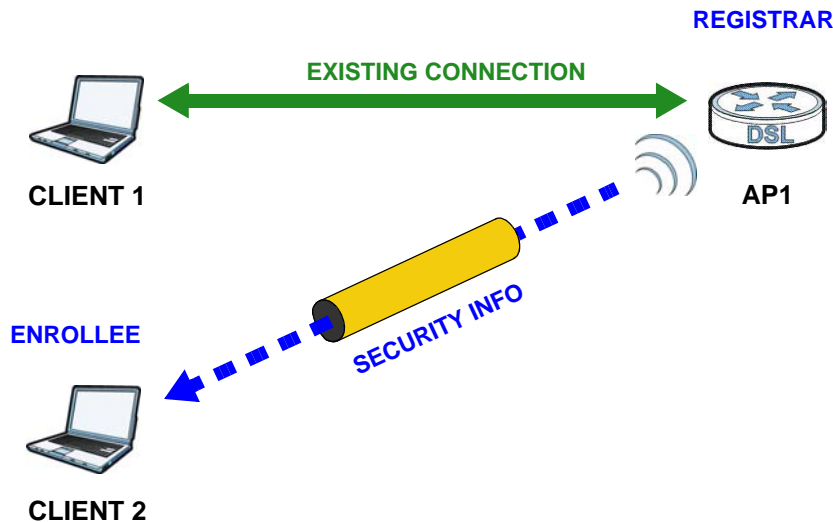

In step 3, you add another access point (**AP2**) to your network. **AP2** is out of range of **AP1**, so you cannot use **AP1** for the WPS handshake with the new access point. However, you know that **Client 2** supports the registrar function, so you use it to perform the WPS handshake instead.

Figure 47 WPS: Example Network Step 3

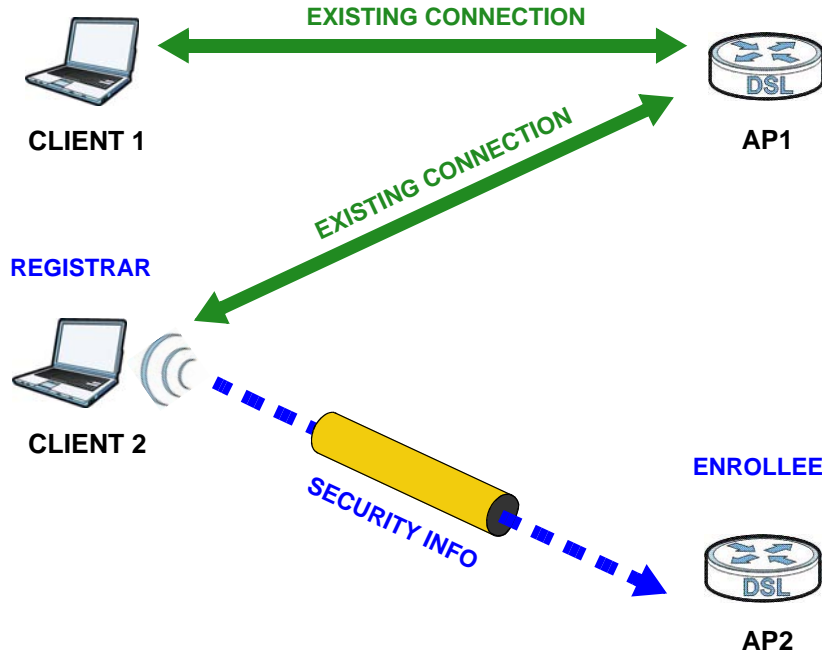

7.10.8.5 Limitations of WPS

WPS has some limitations of which you should be aware.

- WPS works in Infrastructure networks only (where an AP and a wireless client communicate). It does not work in Ad-Hoc networks (where there is no AP).
- When you use WPS, it works between two devices only. You cannot enroll multiple devices simultaneously, you must enroll one after the other.

For instance, if you have two enrollees and one registrar you must set up the first enrollee (by pressing the WPS button on the registrar and the first enrollee, for example), then check that it successfully enrolled, then set up the second device in the same way.

- WPS works only with other WPS-enabled devices. However, you can still add non-WPS devices to a network you already set up using WPS.

WPS works by automatically issuing a randomly-generated WPA-PSK or WPA2-PSK pre-shared key from the registrar device to the enrollee devices. Whether the network uses WPA-PSK or WPA2-PSK depends on the device. You can check the configuration interface of the registrar device to discover the key the network is using (if the device supports this feature). Then, you can enter the key into the non-WPS device and join the network as normal (the non-WPS device must also support WPA-PSK or WPA2-PSK).

- When you use the PBC method, there is a short period (from the moment you press the button on one device to the moment you press the button on the other device) when any WPS-enabled device could join the network. This is because the registrar has no way of identifying the “correct” enrollee, and cannot differentiate between your enrollee and a rogue device. This is a possible way for a hacker to gain access to a network.

You can easily check to see if this has happened. WPS works between only two devices simultaneously, so if another device has enrolled your device will be unable to enroll, and will not have access to the network. If this happens, open the access point’s configuration interface and look at the list of associated clients (usually displayed by MAC address). It does not matter if the

access point is the WPS registrar, the enrollee, or was not involved in the WPS handshake; a rogue device must still associate with the access point to gain access to the network. Check the MAC addresses of your wireless clients (usually printed on a label on the bottom of the device). If there is an unknown MAC address you can remove it or reset the AP.

Home Networking

8.1 Overview

A Local Area Network (LAN) is a shared communication system to which many networking devices are connected. It is usually located in one immediate area such as a building or floor of a building.

Use the LAN screens to help you configure a LAN DHCP server and manage IP addresses.

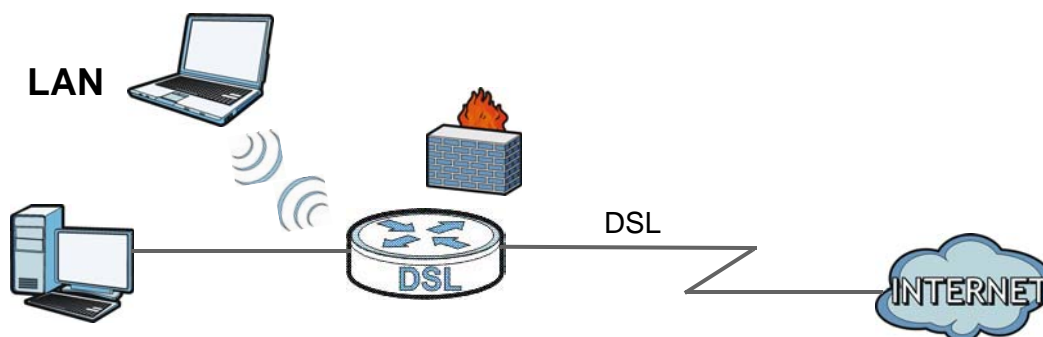

8.1.1 What You Can Do in the LAN Screens

- Use the **LAN Setup** screen to set the LAN IP address, subnet mask, and DHCP settings of your AMG1312-T Series ([Section 8.2 on page 117](#)).
- Use the **Static DHCP** screen to assign IP addresses on the LAN to specific individual computers based on their MAC Addresses ([Section 8.3 on page 119](#)).
- Use the **IP Alias** screen ([Section 8.4 on page 120](#)) to change your AMG1312-T Series's IP alias settings.
- Use the **UPnP** screen to enable UPnP and UPnP NAT traversal on the AMG1312-T Series ([Section 8.5 on page 121](#)).
- Use the **IPv6 LAN Setup** screen ([Section 8.6 on page 122](#)) to configure the IPv6 settings on your AMG1312-T Series's LAN interface.
- Use the **File Sharing** screen to enable file-sharing server ([Section 8.7 on page 125](#)).

8.1.2 What You Need To Know

8.1.2.1 About LAN

IP Address

IP addresses identify individual devices on a network. Every networking device (including computers, servers, routers, printers, etc.) needs an IP address to communicate across the network. These networking devices are also known as hosts.

Subnet Mask

Subnet masks determine the maximum number of possible hosts on a network. You can also use subnet masks to divide one network into multiple sub-networks.

DHCP

A DHCP (Dynamic Host Configuration Protocol) server can assign your AMG1312-T Series an IP address, subnet mask, DNS and other routing information when it's turned on.

DNS

DNS (Domain Name System) is for mapping a domain name to its corresponding IP address and vice versa. The DNS server is extremely important because without it, you must know the IP address of a networking device before you can access it.

8.1.2.2 About UPnP

Identifying UPnP Devices

UPnP hardware is identified as an icon in the Network Connections folder (Windows XP). Each UPnP compatible device installed on your network will appear as a separate icon. Selecting the icon of a UPnP device will allow you to access the information and properties of that device.

NAT Traversal

UPnP NAT traversal automates the process of allowing an application to operate through NAT. UPnP network devices can automatically configure network addressing, announce their presence in the network to other UPnP devices and enable exchange of simple product and service descriptions. NAT traversal allows the following:

- Dynamic port mapping
- Learning public IP addresses
- Assigning lease times to mappings

Windows Messenger is an example of an application that supports NAT traversal and UPnP.

See the [Chapter 11 on page 147](#) for more information on NAT.

Cautions with UPnP

The automated nature of NAT traversal applications in establishing their own services and opening firewall ports may present network security issues. Network information and configuration may also be obtained and modified by users in some network environments.

When a UPnP device joins a network, it announces its presence with a multicast message. For security reasons, the AMG1312-T Series allows multicast messages on the LAN only.

All UPnP-enabled devices may communicate freely with each other without additional configuration. Disable UPnP if this is not your intention.

UPnP and ZyXEL

Sexual has achieved UPnP certification from the Universal Plug and Play Forum UPnP™ Implementers Corp. (UIC). ZyXEL's UPnP implementation supports Internet Gateway Device (IGD) 1.0.

Finding Out More

See [Section 8.8 on page 128](#) for technical background information on LANs.

8.1.3 Before You Begin

Find out the MAC addresses of your network devices if you intend to add them to the DHCP Client List screen.

8.2 The LAN Setup Screen

Use this screen to set the Local Area Network IP address, subnet mask and advanced networking settings such as RIP, multicast of your AMG1312-T Series. Click **Network Setting > Home Networking** to open the **LAN Setup** screen.

Figure 48 Network Setting > Home Networking > LAN Setup

LAN IP Setup

IP Address :

Subnet Mask :

RIP Version : Direction :

Multicast :

IGMP Snooping : Disabled Enabled

DHCP Server State

DHCP : Disable Enable DHCP Relay

IP Addressing Values

IP Pool Starting Address :

Pool Size :

DHCP Server Lease Time

Lease Time : seconds

DNS Values

DNS Server 1 :

DNS Server 2 :

The following table describes the fields in this screen.

Table 31 Network Setting > Home Networking > LAN Setup

LABEL	DESCRIPTION
LAN IP Setup	
IP Address	Enter the LAN IP address you want to assign to your AMG1312-T Series in dotted decimal notation, for example, 192.168.1.1 (factory default).
Subnet Mask	Type the subnet mask of your network in dotted decimal notation, for example 255.255.255.0 (factory default). Your AMG1312-T Series automatically computes the subnet mask based on the IP Address you enter, so do not change this field unless you are instructed to do so.
Dynamic Route	RIP (Routing Information Protocol) allows a router to exchange routing information with other routers. Select the RIP version from RIP1 and RIP2 .
Direction	Use this field to control how much routing information the VDSL Router sends and receives on the subnet. Select the RIP Direction from None , Both , IN Only and OUT Only .
Multicast	IGMP (Internet Group Multicast Protocol) is a network-layer protocol used to establish membership in a multicast group. The AMG1312-T Series supports IGMP v1/IGMP v2/IGMP v3 . Select None to disable it.
IGMP Snooping	Select Enabled to activate IGMP Snooping. This allows the AMG1312-T Series to passively learn memberships in multicast groups. Otherwise, select Disabled to deactivate it.
DHCP Server State	

Table 31 Network Setting > Home Networking > LAN Setup (continued)

LABEL	DESCRIPTION
DHCP	<p>If set to Enable, your AMG1312-T Series can assign IP addresses, an IP default gateway and DNS servers to Windows 95, Windows NT and other systems that support the DHCP client.</p> <p>If set to Disable, the DHCP server will be disabled.</p> <p>If set to DHCP Relay, the AMG1312-T Series acts as a surrogate DHCP server and relays DHCP requests and responses between the remote server and the clients. Enter the IP address of the actual, remote DHCP server in the Remote DHCP Server field in this case.</p> <p>When DHCP is used, the following items need to be set:</p>
IP Addressing Values	
Beginning IP Address	This field specifies the first of the contiguous addresses in the IP address pool.
Pool Size	This field specifies the size, or count of the IP address pool.
DHCP Server Lease Time	
Lease Time	This field specifies the lease time in seconds of an IP address assigned by the DHCP server.
DNS Values	
DNS	<p>Select Dynamic to have the AMG1312-T Series pass a DNS (Domain Name System) server IP address to the DHCP clients.</p> <p>Select Static and enter the DNS server IP address(es) in the fields below, if you know the IP address.</p>
DNS Server 1/2	Enter the IP address of your primary/secondary DNS server.
Apply	Click this to save your changes.
Cancel	Click this to restore your previously saved settings.
Advanced Setup	Click this to display the Advanced LAN Setup screen and edit more details of your LAN setup.

8.3 The Static DHCP Screen

This table allows you to assign IP addresses on the LAN to specific individual computers based on their MAC Addresses.

Every Ethernet device has a unique MAC (Media Access Control) address. The MAC address is assigned at the factory and consists of six pairs of hexadecimal characters, for example, 00:A0:C5:00:00:02.

Use this screen to change your AMG1312-T Series's static DHCP settings. Click **Network Setting > Home Networking > Static DHCP** to open the following screen.

Figure 49 Network Setting > Home Networking > Static DHCP

Add new static lease				
#	Active	MAC Address	IP Address	Modify

The following table describes the labels in this screen.

Table 32 Network Setting > Home Networking > Static DHCP

LABEL	DESCRIPTION
Add new static lease	Click this to add a new static DHCP entry.
#	This is the index number of the entry.
Active	This field displays whether the client is connected to the AMG1312-T Series.
MAC Address	The MAC (Media Access Control) or Ethernet address on a LAN (Local Area Network) is unique to your computer (six pairs of hexadecimal notation). A network interface card such as an Ethernet adapter has a hardwired address that is assigned at the factory. This address follows an industry standard that ensures no other adapter has a similar address.
IP Address	This field displays the IP address relative to the # field listed above.
Modify	Click the Edit icon to have the IP address field editable and change it. Click the Delete icon to delete a static DHCP entry. A window displays asking you to confirm that you want to delete the selected entry.

If you click **Add new static lease** in the **Static DHCP** screen or the **Edit** icon next to a static DHCP entry, the following screen displays.

Figure 50 Static DHCP: Add/Edit

The following table describes the labels in this screen.

Table 33 Static DHCP: Add/Edit

LABEL	DESCRIPTION
MAC Address	If you select Manual Input in the Select Device Info field, enter the MAC address of a computer on your LAN.
IP Address	If you select Manual Input in the Select Device Info field, enter the IP address that you want to assign to the computer on your LAN with the MAC address that you will also specify.
OK	Click OK to save your changes.
Cancel	Click Cancel to exit this screen without saving.

8.4 The IP Alias Screen

IP alias allows you to partition a physical network into different logical networks over the same Ethernet interface. The AMG1312-T Series supports multiple logical LAN interfaces via its physical Ethernet interface with the AMG1312-T Series itself as the gateway for the LAN network.

When you use IP alias, you can also configure firewall rules to control access to the LAN's logical network (subnet).

8.4.1 Configuring the LAN IP Alias Screen

Use this screen to change your AMG1312-T Series's IP alias settings. Click **Network Setting > Home Networking > IP Alias** to open the following screen.

Figure 51 Network Setting > Home Networking > IP Alias

The following table describes the labels in this screen.

Table 34 Network Setting > Home Networking > IP Alias

LABEL	DESCRIPTION
IP Alias	Select Enable to configure a LAN network for the AMG1312-T Series.
IP Address	Enter the IP address of your AMG1312-T Series in dotted decimal notation.
IP Subnet Mask	Your AMG1312-T Series will automatically calculate the subnet mask based on the IP address that you assign. Unless you are implementing subnetting, use the subnet mask computed by the AMG1312-T Series.
Apply	Click this to save your changes.
Cancel	Click this to restore your previously saved settings.

8.5 The UPnP Screen

Universal Plug and Play (UPnP) is a distributed, open networking standard that uses TCP/IP for simple peer-to-peer network connectivity between devices. A UPnP device can dynamically join a network, obtain an IP address, convey its capabilities and learn about other devices on the network. In turn, a device can leave a network smoothly and automatically when it is no longer in use.

See [page 116](#) for more information on UPnP.

Use the following screen to enable or disable the UPnP function on your AMG1312-T Series. Click **Network Setting > Home Networking > UPnP** to display the screen shown next.

Figure 52 Network Setting > Home Networking > UPnP

The following table describes the labels in this screen.

Table 35 Network Setting > Home Networking > UPnP

LABEL	DESCRIPTION
UPnP	Select Enable to activate UPnP. Be aware that anyone could use a UPnP application to open the web configurator's login screen without entering the AMG1312-T Series's IP address (although you must still enter the password to access the web configurator). Otherwise, select Disable to deactivate UPnP.
Apply	Click Apply to save your changes.
Cancel	Click Cancel to exit this screen without saving.

8.6 The IPv6 LAN Setup Screen

Use this screen to configure the IPv6 settings for your AMG1312-T Series's LAN interface. See [Appendix E on page 277](#) for background information about IPv6.

Figure 53 Network Setting > Home Networking > IPv6 LAN Setup

IPv6 LAN Setup

Link Local Address Type : Manual EUI64

IPv6 Address :

Prefix :

MLD Snooping : Enabled Disabled

Lan Global Identifier Type : Manual EUI64

Lan Identifier :

IPv6 ULA Address Type : Auto Generate Manual

IPv6 ULA Address :

LAN IPv6 Address Setting

Delegate prefix from WAN Static

Static IPv6 Address Prefix :

Prefix length :

Preferred Lifetime :

Valid Lifetime :

LAN IPv6 Address Assign Setup:

LAN IPv6 DNS Assign Setup:

DHCPv6

DHCPv6 Server : Disable Enable

DNSv6 Mode: Proxy Relay Manual

Primary DNS :

Secondary DNS :

Information refresh time :

DNS Query Mode :

The following table describes the labels in this screen.

Table 36 Network Setting > Home Networking > IPv6 LAN Setup

LABEL	DESCRIPTION
IPv6 LAN Setup	
Link Local Address Type	Select Manual to manually enter a link local address. Select EUI 64 to use the EUI-64 format to generate a link local address from the Ethernet MAC address.
IPv6 Address	If you selected Manual in the Link Local Address Type field, enter the LAN IPv6 address you want to assign to your AMG1312-T Series in hexadecimal notation, for example, fe80::1 (factory default).
Prefix	Enter the address prefix to specify how many most significant bits in an IPv6 address compose the network address.
MLD Snooping	Multicast Listener Discovery (MLD) allows an IPv6 switch or router to discover the presence of MLD hosts who wish to receive multicast packets and the IP addresses of multicast groups the hosts want to join on its network. Select Enabled to activate MLD Snooping on the AMG1312-T Series. This allows the AMG1312-T Series to check MLD packets passing through it and learn the multicast group membership. It helps reduce multicast traffic.
Lan Global Identifier Type	Select Manual to manually enter a LAN Identifier as the interface ID to identify the LAN interface. The LAN Identifier is appended to the IPv6 address prefix to create the routable global IPv6 address. Select EUI 64 to use the EUI-64 format to generate an interface ID from the Ethernet MAC address.
Lan Identifier	If you selected Manual , enter the LAN Identifier in this field. The LAN identifier should be unique and 64 bits in hexadecimal form. Every 16 bit block should be separated by a colon as in XXXX:XXXX:XXXX:XXXX where X is a hexadecimal character. Blocks of zeros can be represented with double colons as in XXXX:XXXX::XXXX.
LAN IPv6 Address Setting	
Delegate prefix from WAN	Select this option to automatically obtain an IPv6 network prefix from the service provider or an uplink router.
Static	Select this option to configure a fixed IPv6 address for the AMG1312-T Series's LAN IPv6 address.
Static IPv6 Address Prefix	If you select static IPv6 address, enter the IPv6 address prefix that the AMG1312-T Series uses for the LAN IPv6 address.
Prefix length	If you select static IPv6 address, enter the IPv6 prefix length that the AMG1312-T Series uses to generate the LAN IPv6 address. An IPv6 prefix length specifies how many most significant bits (starting from the left) in the address compose the network address. This field displays the bit number of the IPv6 subnet mask.
Preferred Lifetime	Enter the preferred lifetime for the prefix.
Valid Lifetime	Enter the valid lifetime for the prefix.
RADVD Setup	

Table 36 Network Setting > Home Networking > IPv6 LAN Setup (continued)

LABEL	DESCRIPTION
Send RA on	<p>Select this to have the AMG1312-T Series send router advertisement messages to the LAN hosts.</p> <p>Router advertisement is a response to a router solicitation or a periodical multicast advertisement from a router to advertise its presence and other parameters, such as IPv6 prefix and DNS information.</p> <p>Router solicitation is a request from a host to locate a router that can act as the default router and forward packets.</p> <p>Note: The LAN hosts neither generate global IPv6 addresses nor communicate with other networks if you disable this feature.</p>
Delegate M/O flag from WAN	Select this to have the AMG1312-T Series obtain the M/O (Managed/Other) flag setting from the service provider or uplink router.
Manual	Select this to specify the M/O flag setting manually.
Managed config flag on	<p>Select this to have the AMG1312-T Series indicate to hosts to obtain network settings (such as prefix and DNS settings) through DHCPv6.</p> <p>Clear this to have the AMG1312-T Series indicate to hosts that DHCPv6 is not available and they should use the prefix in the router advertisement message.</p>
Other config flag on	<p>Select this to have the AMG1312-T Series indicate to hosts to obtain DNS information through DHCPv6.</p> <p>Clear this to have the AMG1312-T Series indicate to hosts that DNS information is not available in this network.</p>
Advertisement interval option on	Select this to have the Router Advertisement messages the VDSL Router sends specify the allowed interval between Router Advertisement messages.
Hop limit	Enter the maximum number of network segments that a packet can cross before reaching the destination. When forwarding an IPv6 packet, IPv6 routers are required to decrease the Hop Limit by 1 and to discard the IPv6 packet when the Hop Limit is 0. Possible value for this field are 0-255.
Router Lifetime	Enter the time in seconds that hosts should consider the AMG1312-T Series to be the default router. Possible values for this field are 0-9000.
Router Preference	<p>Select the router preference (Low, Medium or High) for the AMG1312-T Series. The AMG1312-T Series sends this preference in the router advertisements to tell hosts what preference they should use for the AMG1312-T Series. This helps hosts to choose their default router especially when there are multiple IPv6 router in the network.</p> <p>Note: Make sure the hosts also support router preference to make this function work.</p>
Reachable Time (ms)	Enter the time in milliseconds that can elapse before a neighbor is detected. Possible values for this field are 0-3600000.
Retrans Timer (ms)	Enter the time in milliseconds between neighbor solicitation packet retransmissions. Possible values for this field are 1000-4294967295.
RA Interval	Enter the time in seconds between router advertisement messages. Possible values for this field are 4-1800.
Delegate MTU from WAN	Select this to have the AMG1312-T Series obtain the MTU setting from the service provider or uplink router.
Manual	Select this to specify the MTU manually.
MTU	The Maximum Transmission Unit. Type the maximum size of each IPv6 data packet, in bytes, that can move through this interface. If a larger packet arrives, the AMG1312-T Series divides it into smaller fragments.

Table 36 Network Setting > Home Networking > IPv6 LAN Setup (continued)

LABEL	DESCRIPTION
DAD attempts	Specify the number of DAD (Duplicate Address Detection) attempts before an IPv6 address is assigned to the AMG1312-T Series LAN interface. Possible values for this field are 1-7.
DHCPv6	
DHCPv6 Server	Use this field to Enable or Disable DHCPv6 server on the AMG1312-T Series.
DNSv6 Mode	Select the DNS role (Proxy or Relay) that you want the AMG1312-T Series to act in the IPv6 LAN network. Alternatively, select Manual and specify the DNS servers' IPv6 address in the fields below.
Primary DNS	This field is available if you choose Manual as the DNSv6 mode. Enter the first DNS server IPv6 address the AMG1312-T Series passes to the DHCP clients.
Secondary DNS	This field is available if you choose Manual as the DNSv6 mode. Enter the second DNS server IPv6 address the AMG1312-T Series passes to the DHCP clients.
Information refresh time	Enter the number of seconds a DHCPv6 client should wait before refreshing information retrieved from DHCPv6.
Apply	Click this to save your changes.
Cancel	Click this to restore your previously saved settings.

8.7 The File Sharing Screen

Use this screen to set up file sharing through the AMG1312-T Series. The AMG1312-T Series's LAN users can access the shared folder (or share) from the USB device inserted in the AMG1312-T Series. To access this screen, click **Network Setting > Home Networking > File Sharing**.

Figure 54 Network Setting > Home Networking > File Sharing

Server Configuration

Active the File Sharing Services (SMB)

Share Directory Access Level: Public



Account Management

#	Status	User Name	Modify
1	⚡		🗑️
2	⚡		🗑️
14	⚡		🗑️
15	⚡		🗑️
16	⚡		🗑️

Apply Cancel

Each field is described in the following table.

Table 37 Network Setting > Home Networking > File Sharing

LABEL	DESCRIPTION
Server Configuration	
Active the File Sharing Services (SMB)	Select Active the File Sharing Services (SMB) to activate file sharing through the AMG1312-T Series.
Share Directory Access Level	Select Public to allow all users on the network to access the shared files. Select Security to require users to log in to access shared files.
Account Management	
#	This field shows the number of the user.
Status	This field shows the status of the user.  : The user account is not activated for the share.  : The user account is activated for the share.
User Name	This is the name of a user who is allowed to access the secured shares on the USB device.
Modify	Click the Edit icon to modify the user account. Click the Delete icon to remove the user account from the AMG1312-T Series.
Apply	Click this to save your changes to the AMG1312-T Series.
Cancel	Click this to restore your previously saved settings.

8.7.1 The User Edit Screen

Use this screen to edit an user. To access this screen, click the **Edit** button in the **Network Setting > Home Networking > File Sharing** screen.

Figure 55 Network Setting > Home Networking > File Sharing > Edit

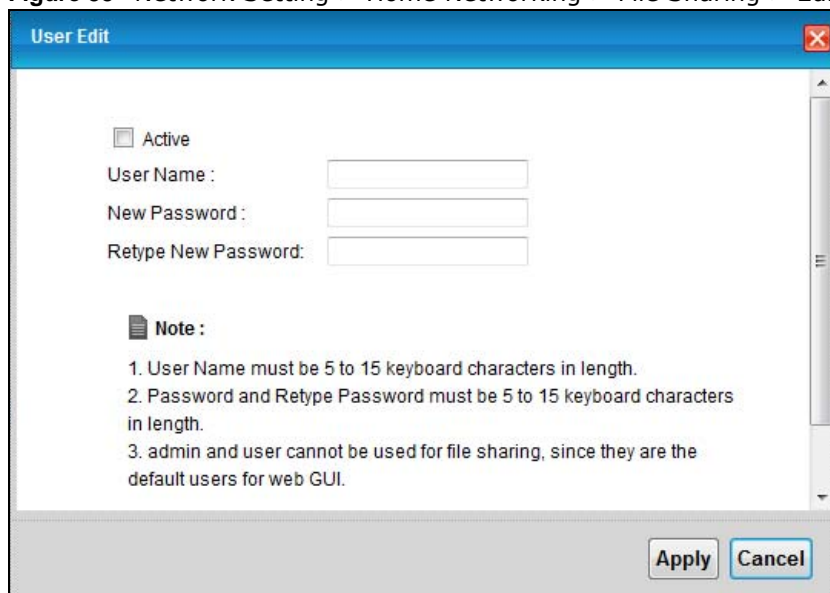

User Edit

Active

User Name :

New Password :

Retype New Password:

Note :

1. User Name must be 5 to 15 keyboard characters in length.
2. Password and Retype Password must be 5 to 15 keyboard characters in length.
3. admin and user cannot be used for file sharing, since they are the default users for web GUI.

Apply Cancel

Each field is described in the following table.

Table 38 Network Setting > Home Networking > File Sharing > Edit

LABEL	DESCRIPTION
Active	Select Active to edit user file sharing through the AMG1312-T Series.
User Name	Type in the user name of 5 to 15 keyboard characters in length.
New Password	Type in the new password of 5 to 15 keyboard characters in length.
Retype New Password	Retype the new password of 5 to 15 keyboard characters in length.
Apply	Click this to save your changes to the AMG1312-T Series.
Cancel	Click this to restore your previously saved settings.

8.8 Home Networking Technical Reference

This section provides some technical background information about the topics covered in this chapter.

8.8.1 LANs, WANs and the AMG1312-T Series

The actual physical connection determines whether the AMG1312-T Series ports are LAN or WAN ports. There are two separate IP networks, one inside the LAN network and the other outside the WAN network as shown next.

Figure 56 LAN and WAN IP Addresses

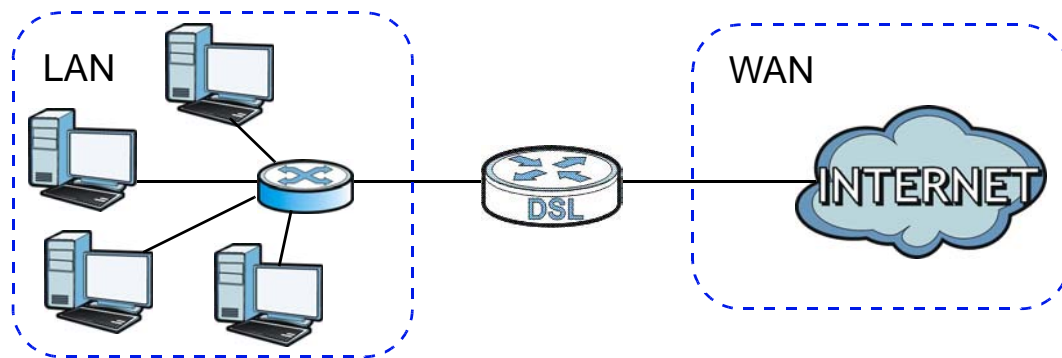

8.8.2 DHCP Setup

DHCP (Dynamic Host Configuration Protocol, RFC 2131 and RFC 2132) allows individual clients to obtain TCP/IP configuration at start-up from a server. You can configure the AMG1312-T Series as a DHCP server or disable it. When configured as a server, the AMG1312-T Series provides the TCP/IP configuration for the clients. If you turn DHCP service off, you must have another DHCP server on your LAN, or else the computer must be manually configured.

IP Pool Setup

The AMG1312-T Series is pre-configured with a pool of IP addresses for the DHCP clients (DHCP Pool). Do not assign static IP addresses from the DHCP pool to your LAN computers.

8.8.3 DNS Server Addresses

DNS (Domain Name System) maps a domain name to its corresponding IP address and vice versa. The DNS server is extremely important because without it, you must know the IP address of a computer before you can access it. The DNS server addresses you enter when you set up DHCP are passed to the client machines along with the assigned IP address and subnet mask.

There are two ways that an ISP disseminates the DNS server addresses.

- The ISP tells you the DNS server addresses, usually in the form of an information sheet, when you sign up. If your ISP gives you DNS server addresses, enter them in the **DNS Server** fields in the **DHCP Setup** screen.

- Some ISPs choose to disseminate the DNS server addresses using the DNS server extensions of IPCP (IP Control Protocol) after the connection is up. If your ISP did not give you explicit DNS servers, chances are the DNS servers are conveyed through IPCP negotiation. The AMG1312-T Series supports the IPCP DNS server extensions through the DNS proxy feature.

Please note that DNS proxy works only when the ISP uses the IPCP DNS server extensions. It does not mean you can leave the DNS servers out of the DHCP setup under all circumstances. If your ISP gives you explicit DNS servers, make sure that you enter their IP addresses in the **DHCP Setup** screen.

8.8.4 LAN TCP/IP

The AMG1312-T Series has built-in DHCP server capability that assigns IP addresses and DNS servers to systems that support DHCP client capability.

IP Address and Subnet Mask

Similar to the way houses on a street share a common street name, so too do computers on a LAN share one common network number.

Where you obtain your network number depends on your particular situation. If the ISP or your network administrator assigns you a block of registered IP addresses, follow their instructions in selecting the IP addresses and the subnet mask.

If the ISP did not explicitly give you an IP network number, then most likely you have a single user account and the ISP will assign you a dynamic IP address when the connection is established. If this is the case, it is recommended that you select a network number from 192.168.0.0 to 192.168.255.0 and you must enable the Network Address Translation (NAT) feature of the AMG1312-T Series. The Internet Assigned Number Authority (IANA) reserved this block of addresses specifically for private use; please do not use any other number unless you are told otherwise. Let's say you select 192.168.1.0 as the network number; which covers 254 individual addresses, from 192.168.1.1 to 192.168.1.254 (zero and 255 are reserved). In other words, the first three numbers specify the network number while the last number identifies an individual computer on that network.

Once you have decided on the network number, pick an IP address that is easy to remember, for instance, 192.168.1.1, for your AMG1312-T Series, but make sure that no other device on your network is using that IP address.

The subnet mask specifies the network number portion of an IP address. Your AMG1312-T Series will compute the subnet mask automatically based on the IP address that you entered. You don't need to change the subnet mask computed by the AMG1312-T Series unless you are instructed to do otherwise.

Private IP Addresses

Every machine on the Internet must have a unique address. If your networks are isolated from the Internet, for example, only between your two branch offices, you can assign any IP addresses to the hosts without problems. However, the Internet Assigned Numbers Authority (IANA) has reserved the following three blocks of IP addresses specifically for private networks:

- 10.0.0.0 — 10.255.255.255
- 172.16.0.0 — 172.31.255.255

- 192.168.0.0 — 192.168.255.255

You can obtain your IP address from the IANA, from an ISP or it can be assigned from a private network. If you belong to a small organization and your Internet access is through an ISP, the ISP can provide you with the Internet addresses for your local networks. On the other hand, if you are part of a much larger organization, you should consult your network administrator for the appropriate IP addresses.

Note: Regardless of your particular situation, do not create an arbitrary IP address; always follow the guidelines above. For more information on address assignment, please refer to RFC 1597, "Address Allocation for Private Internets" and RFC 1466, "Guidelines for Management of IP Address Space".

8.8.5 RIP Setup

RIP (Routing Information Protocol) allows a router to exchange routing information with other routers. The **RIP Direction** field controls the sending and receiving of RIP packets. When set to:

- **Both** - the AMG1312-T Series will broadcast its routing table periodically and incorporate the RIP information that it receives.
- **In Only** - the AMG1312-T Series will not send any RIP packets but will accept all RIP packets received.
- **Out Only** - the AMG1312-T Series will send out RIP packets but will not accept any RIP packets received.
- **None** - the AMG1312-T Series will not send any RIP packets and will ignore any RIP packets received.

The **Version** field controls the format and the broadcasting method of the RIP packets that the AMG1312-T Series sends (it recognizes both formats when receiving). RIP-1 is universally supported; but RIP-2 carries more information. RIP-1 is probably adequate for most networks, unless you have an unusual network topology.

Both RIP-2B and RIP-2M sends the routing data in RIP-2 format; the difference being that RIP-2B uses subnet broadcasting while RIP-2M uses multicasting. Multicasting can reduce the load on non-router machines since they generally do not listen to the RIP multicast address and so will not receive the RIP packets. However, if one router uses multicasting, then all routers on your network must use multicasting, also.

8.8.6 Multicast

Traditionally, IP packets are transmitted in one of either two ways - Unicast (1 sender - 1 recipient) or Broadcast (1 sender - everybody on the network). Multicast delivers IP packets to a group of hosts on the network - not everybody and not just 1.

IGMP (Internet Group Multicast Protocol) is a network-layer protocol used to establish membership in a Multicast group - it is not used to carry user data. IGMP version 2 (RFC 2236) is an improvement over version 1 (RFC 1112) but IGMP version 1 is still in wide use. IGMP version 3 supports source filtering, reporting or ignoring traffic from specific source address to a particular host on the network. If you would like to read more detailed information about interoperability between IGMP version 2 and version 1, please see sections 4 and 5 of RFC 2236. The class D IP address is used to identify host groups and can be in the range 224.0.0.0 to 239.255.255.255. The address 224.0.0.0 is not assigned to any group and is used by IP multicast computers. The address

224.0.0.1 is used for query messages and is assigned to the permanent group of all IP hosts (including gateways). All hosts must join the 224.0.0.1 group in order to participate in IGMP. The address 224.0.0.2 is assigned to the multicast routers group.

At start up, the AMG1312-T Series queries all directly connected networks to gather group membership. After that, the AMG1312-T Series periodically updates this information. IP multicasting can be enabled/disabled on the AMG1312-T Series LAN and/or WAN interfaces in the web configurator (**LAN**; **WAN**). Select **None** to disable IP multicasting on these interfaces.

Static Route

9.1 Overview

The AMG1312-T Series usually uses the default gateway to route outbound traffic from computers on the LAN to the Internet. To have the AMG1312-T Series send data to devices not reachable through the default gateway, use static routes.

For example, the next figure shows a computer (**A**) connected to the AMG1312-T Series's LAN interface. The AMG1312-T Series routes most traffic from **A** to the Internet through the AMG1312-T Series's default gateway (**R1**). You create one static route to connect to services offered by your ISP behind router **R2**. You create another static route to communicate with a separate network behind a router **R3** connected to the LAN.

Figure 57 Example of Static Routing Topology

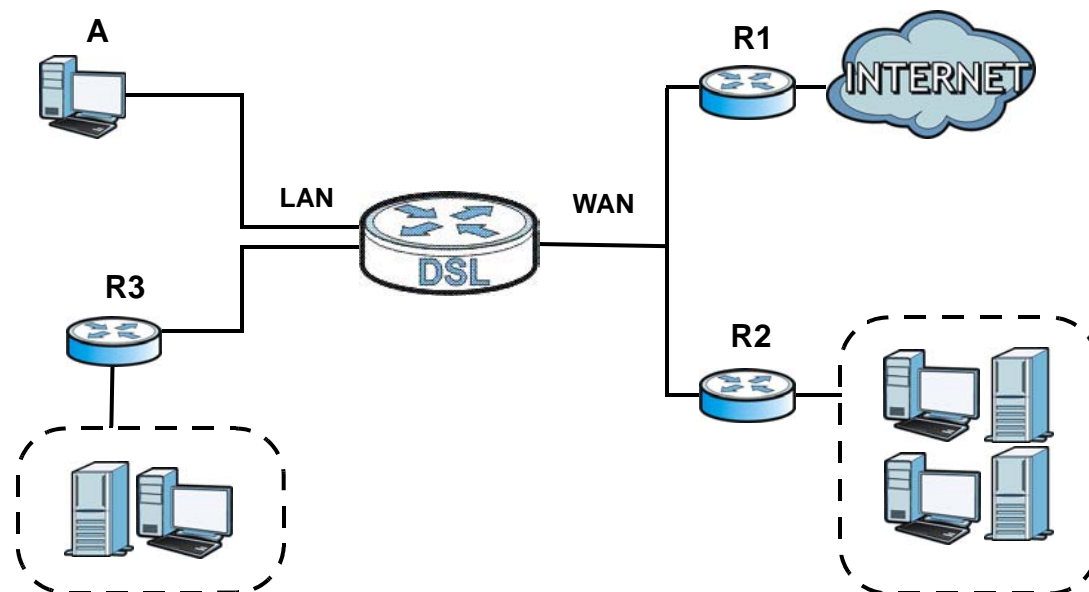

9.1.1 What You Can Do in the Static Route Screens

- Use the **Static Route** screens ([Section 9.2 on page 133](#)) to view and configure IP static routes on the AMG1312-T Series.
- Use the **IPv6 Static Route** screens ([Section 9.3 on page 134](#)) to view and configure IPv6 static routes on the AMG1312-T Series.

9.2 The Static Route Screen

Use this screen to view the static route rules. Click **Network Setting > Static Route** to open the **Static Route** screen.

Figure 58 Network Setting > Static Route



The following table describes the labels in this screen.

Table 39 Network Setting > Static Route

LABEL	DESCRIPTION
Add new static route	Click this to configure a new static route.
#	This is the number of an individual static route.
Destination IP	This parameter specifies the IP network address of the final destination. Routing is always based on network number.
Gateway	This is the IP address of the gateway. The gateway is a router or switch on the same network segment as the device's LAN or WAN port. The gateway helps forward packets to their destinations.
Subnet Mask	This parameter specifies the IP network subnet mask of the final destination.
Metric	This is the number of transmission hops between this AMG1312-T Series and the destination.
Modify	Click the Edit icon to go to the screen where you can set up a static route on the AMG1312-T Series. Click the Delete icon to remove a static route from the AMG1312-T Series. A window displays asking you to confirm that you want to delete the route.

9.2.1 Static Route Add/Edit

Use this screen to add or edit a static route. Click **Add new Static Route Entry** in the **Routing** screen or the **Edit** icon next to the static route you want to edit. The screen shown next appears.

Figure 59 Network Setting > Static Route Add/Edit

The following table describes the labels in this screen.

Table 40 Network Setting > Static Route Add/Edit

LABEL	DESCRIPTION
Destination IP Address	This parameter specifies the IP network address of the final destination. Routing is always based on network number. If you need to specify a route to a single host, use a subnet mask of 255.255.255.255 in the subnet mask field to force the network number to be identical to the host ID.
IP Subnet Mask	Enter the IP subnet mask here.
Gateway IP Address	Enter the IP address of the gateway. The gateway is a router or switch on the same network segment as the device's LAN or WAN port. The gateway helps forward packets to their destinations.
Metric	Enter the number of transmission hops (routers) that need to cross from the AMG1312-T Series to the destination.
OK	Click this to save your changes.
Cancel	Click this to restore your previously saved settings.

9.3 IPv6 Static Route

Use this screen to view the IPv6 static route rules. Click **Network Setting > Static Route > IPv6 Static Route** to open the **IPv6 Static Route** screen.

Figure 60 Network Setting > Static Route > IPv6 Static Route

The following table describes the labels in this screen.

Table 41 Network Setting > Static Route > IPv6 Static Route

LABEL	DESCRIPTION
Add new static route	Click this to configure a new IPv6 static route.
#	This is the number of an individual static route.

Table 41 Network Setting > Static Route > IPv6 Static Route (continued)

LABEL	DESCRIPTION
Destination	This parameter specifies the IP network address of the final destination. Routing is always based on network number.
Prefix Length	An IPv6 prefix length specifies how many most significant bits (starting from the left) in the address compose the network address. This field displays the bit number of the IPv6 subnet mask.
Device	This specifies the LAN or WAN PVC.
Modify	Click the Edit icon to go to the screen where you can set up a static route on the AMG1312-T Series. Click the Remove icon to remove a static route from the AMG1312-T Series. A window displays asking you to confirm that you want to delete the route.

9.3.1 IPv6 Static Route Edit

Use this screen to configure the required information for an IPv6 static route. Click **Add new static route** or select an IPv6 static route index number and click **Edit**. The screen shown next appears.

Figure 61 Network Setting > Static Route > IPv6 Static Route: Add/Edit

The following table describes the labels in this screen.

Table 42 Network Setting > Static Route > IPv6 Static Route: Add/Edit

LABEL	DESCRIPTION
Destination IPv6 Address	This parameter specifies the IP network address of the final destination. Routing is always based on network number. If you need to specify a route to a single host, use a prefix length of 128 in the prefix length field to force the network number to be identical to the host ID.
IPv6 Prefix Length	Enter the address prefix to specify how many most significant bits compose the network address.
PVC IPv6 Address	Select the interface through which the traffic is routed.
OK	Click this to save your changes.
Cancel	Click this to restore your previously saved settings.

Quality of Service (QoS)

10.1 Overview

Use the **QoS** screen to set up your AMG1312-T Series to use QoS for traffic management.

Quality of Service (QoS) refers to both a network's ability to deliver data with minimum delay, and the networking methods used to control bandwidth. QoS allows the AMG1312-T Series to group and prioritize application traffic and fine-tune network performance.

Without QoS, all traffic data are equally likely to be dropped when the network is congested. This can cause a reduction in network performance and make the network inadequate for time-critical applications such as video-on-demand.

The AMG1312-T Series assigns each packet a priority and then queues the packet accordingly. Packets assigned with a high priority are processed more quickly than those with low priorities if there is congestion, allowing time-sensitive applications to flow more smoothly. Time-sensitive applications include both those that require a low level of latency (delay) and a low level of jitter (variations in delay) such as Voice over IP (VoIP) or Internet gaming, and those for which jitter alone is a problem such as Internet radio or streaming video.

In the following figure, your Internet connection has an upstream transmission speed of 50 Mbps. You configure a classifier to assign the highest priority queue (6) to VoIP traffic from the LAN interface, so that voice traffic would not get delayed when there is network congestion. Traffic from the boss's IP address (192.168.1.23 for example) is mapped to queue 5. Traffic that does not match these two classes are assigned priority queue based on the internal QoS mapping table on the AMG1312-T Series.

Figure 62 QoS Example

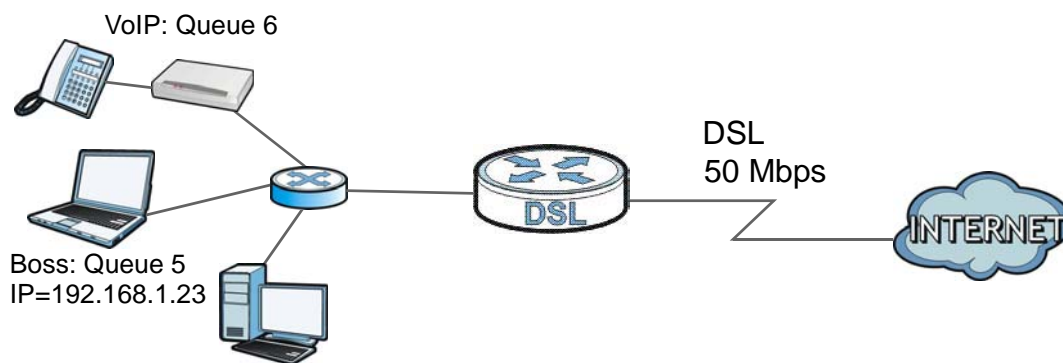

10.1.1 What You Can Do in the QoS Screens

- Use the **General** screen ([Section 10.2 on page 137](#)) to enable QoS on the AMG1312-T Series, and specify the type of scheduling.

- Use the **Queue** screen ([Section 10.3 on page 138](#)) to configure QoS settings on the AMG1312-T Series.
- Use the **Class Setup** screen ([Section 10.4 on page 140](#)) to configure QoS settings on the AMG1312-T Series.
- Use the **Game List** screen ([Section 10.5 on page 144](#)) to give priority to traffic for specific games.

10.1.2 What You Need to Know About QoS

802.1p

QoS is used to prioritize source-to-destination traffic flows. All packets in the same flow are given the same priority. 802.1p is a way of managing traffic in a network by grouping similar types of traffic together and treating each type as a class. You can use 802.1p to give different priorities to different packet types.

Tagging and Marking

In a QoS class, you can configure whether to add or change the DiffServ Code Point (DSCP) value and IEEE 802.1p priority level in a matched packet. When the packet passes through a compatible network, the networking device, such as a backbone switch, can provide specific treatment or service based on the tag or marker.

Finding Out More

See [Section 10.6 on page 145](#) for advanced technical information on QoS.

10.2 The Quality of Service General Screen

Use this screen to enable or disable QoS and set the upstream bandwidth.

Click **Network Setting > QoS > General** to open the screen as shown next.

Figure 63 Network Setting > QoS > General



Active QoS

Traffic priority will be automatically assigned by None

Apply Cancel

The following table describes the labels in this screen.

Table 43 Network Setting > QoS > General













LABEL	DESCRIPTION
Active QoS	Use this field to turn on QoS to improve your network performance.
Traffic priority will be automatically assigned by	<p>Select how the AMG1312-T Series assigns priorities to various incoming and outgoing traffic flows.</p> <ul style="list-style-type: none"> • None: Disables auto priority mapping and has the AMG1312-T Series put packets into the queues according to your classification rules. Traffic which does not match any of the classification rules is mapped into the default queue with the lowest priority. • Ethernet Priority: Automatically assign priority based on the IEEE 802.1p priority level. • IP Precedence: Automatically assign priority based on the first three bits of the TOS field in the IP header. • Packet Length: Automatically assign priority based on the packet size. Smaller packets get higher priority since control, signaling, VoIP, internet gaming, or other real-time packets are usually small while larger packets are usually best effort data packets like file transfers.
Apply	Click this to save your changes.
Cancel	Click this to restore your previously saved settings.

10.3 The Queue Screen

Use this screen to configure QoS queue assignment disciplines and priorities.

Click **Network Setting > QoS > Queue** to open the screen as shown next.

Figure 64 Network Setting > QoS > Queue

Inde	Status	Name	Interface	Priority	Weight	Rate Limit	Modify
1		Queue1	WAN	1	1	N/A	 
2		N/A	N/A	N/A	N/A	N/A N/A	 
3		N/A	N/A	N/A	N/A	N/A N/A	 
4		N/A	N/A	N/A	N/A	N/A N/A	 

The following table describes the labels in this screen.

Table 44 Network Setting > QoS > Queue

LABEL	DESCRIPTION
#	This is the index number of the entry.
Status	This field displays whether the queue is active or not. A yellow bulb signifies that this queue is active. A gray bulb signifies that this queue is not active.
Name	This shows the descriptive name of this queue.
Interface	This shows the name of the AMG1312-T Series's interface through which traffic in this queue passes.
Priority	This shows the priority of this queue.
Weight	This shows the weight of this queue.

Table 44 Network Setting > QoS > Queue (continued)

LABEL	DESCRIPTION
Rate Limit	This shows the maximum transmission rate allowed for traffic on this queue.
Modify	Click the Edit icon to edit the queue. Click the Delete icon to delete an existing queue. Note that subsequent rules move up by one when you take this action.

10.3.1 Adding a QoS Queue

Click the edit icon in the **Queue Setup** screen to configure a queue.

Figure 65 Queue Setup: Edit

The following table describes the labels in this screen.

Table 45 Queue Setup: Edit

LABEL	DESCRIPTION
Active	Select to enable or disable this queue.
Name	Enter the descriptive name of this queue.
Interface	Select the interface to which this queue is applied. This field is read-only if you are editing the queue.
Priority	Select the priority level (from 1 to 3) of this queue. The smaller the number, the higher the priority level. Traffic assigned to higher priority queues gets through faster while traffic in lower priority queues is dropped if the network is congested.
Weight	Select the weight (from 1 to 8) of this queue. If two queues have the same priority level, the AMG1312-T Series divides the bandwidth across the queues according to their weights. Queues with larger weights get more bandwidth than queues with smaller weights.
Rate Limit	Specify the maximum transmission rate (in Kbps) allowed for traffic on this queue.
OK	Click OK to save your changes.
Cancel	Click Cancel to exit this screen without saving.

10.4 The Class Setup Screen

Use this screen to add, edit or delete QoS classifiers. A classifier groups traffic into data flows according to specific criteria such as the source address, destination address, source port number, destination port number or incoming interface. For example, you can configure a classifier to select traffic from the same protocol port (such as Telnet) to form a flow.

You can give different priorities to traffic that the AMG1312-T Series forwards out through the WAN interface. Give high priority to voice and video to make them run more smoothly. Similarly, give low priority to many large file downloads so that they do not reduce the quality of other applications.

Click **Network Setting > QoS > Class Setup** to open the screen as shown next.

Figure 66 Network Setting > QoS > Class Setup

Index	Status	From Interface	Classification Criteria	DSCP(Traffic Class) Mark	802.1P/1Q Mark	To Queue	Modify
-------	--------	----------------	-------------------------	--------------------------	----------------	----------	--------

The following table describes the labels in this screen.

Table 46 Network Setting > QoS > Class Setup

LABEL	DESCRIPTION
Add new Classifier	Click this to create a new classifier.
Index	This is the index number of the entry.
Status	This field displays whether the classifier is active or not. A yellow bulb signifies that this classifier is active. A gray bulb signifies that this classifier is not active.
From Interface	This shows the interface from which traffic of this class should come.
Classification Criteria	This shows criteria specified in this classifier, for example the type and the source MAC address of traffic that matches this classifier.
DSCP Mark	This is the DSCP number added to traffic of this classifier.
802.1P/1Q Mark	This is the IEEE 802.1p priority level and 802.1Q VLAN tag assigned to traffic of this classifier.
To Queue	This is the name of the queue in which traffic of this classifier is put.
Modify	Click the Edit icon to edit the classifier. Click the Delete icon to delete an existing classifier. Note that subsequent rules move up by one when you take this action.

10.4.1 Class Setup Add/Edit

Click **Add new Classifier** in the **Network Setting > QoS > Class Setup** screen or click the **Edit** icon next to a class, the screen appears as shown next.

Figure 67 QoS > Class Setup Add/Edit

Add new Classifier

Rule Index [Dropdown]

Class Configuration

Active

Ether Type: IPv4 (0x0800) [Dropdown]

Interface: From LAN [Dropdown]

To Queue: [Dropdown]

Criteria Configuration

Use the configurations below to specify the characteristics of a data flow need to be managed by this QoS rule

▪ **Basic**

From Interface: LAN1 LAN2 LAN3 LAN4 ra0 ra1 ra2 ra3

▪ **Source**

IP Address [Text] IP Subnet Mask [Text] Exclude

Port Range [Text] ~ [Text] Exclude

MAC Address [Text] MAC Mask [Text] Exclude

▪ **Destination**

IP Address [Text] IP Subnet Mask [Text] Exclude

Port Range [Text] ~ [Text] Exclude

MAC Address [Text] MAC Mask [Text] Exclude

▪ **Others**

Service [Dropdown]

IP Protocol [Dropdown] Exclude

TCP ACK Exclude

DHCP [Text] [Text] Exclude

Packet Length [Text] ~ [Text] Exclude

IPP/DS Field IPP/TOS DSCP

IP Precedence Range [Dropdown] ~ [Dropdown] Exclude

Type of Service [Dropdown] Exclude

DSCP Range(0 ~ 63) [Text] ~ [Text] Exclude

802.1P [Dropdown] ~ [Dropdown] Exclude

VLAN ID [Text] ~ [Text] (Value Range: 1 ~ 4094) Exclude

Action

Forward to: Unchange [Dropdown]

IPP/DS Field: IPP/TOS DSCP

IP Precedence Mark: Unchange [Dropdown] [Dropdown]

Type Of Service Mark: Unchange [Dropdown] [Dropdown]

DSCP Mark(0 ~ 63): Unchange [Dropdown] [Text]

802.1Q Tag: Same [Dropdown]

- Ethernet Priority: [Dropdown] [Dropdown]

- VLAN ID: [Text] (Value Range: 1 ~ 4094)

OK Cancel

The following table describes the labels in this screen.

Table 47 QoS > Class Setup Add/Edit

LABEL	DESCRIPTION
Rule Index	Select the rule's index number from the drop-down list box.
Class Configuration	
Active	Use this field to enable or disable the QoS class rule.
Ether Type	Select a predefined application to configure a class for the matched traffic. If you select IPv4 or IPv6 , you also need to configure source or destination IP address, MAC address, DHCP options, DSCP value or the protocol type. If you select ARP , you also need to configure source or destination MAC address. If you select 802.1Q , you can configure an 802.1p priority level and VLAN ID.
Interface	Select an interface if you want to classify the traffic received by it.
To Queue	Select a queue that applies to this class. You should have configured a queue in the Queue Setup screen already.
Criteria Configuration	
Basic	
From Interface	If you select From LAN in the Interface field, you can select specific interface(s) from which traffic is received. ra0 ~ ra3 means wireless interfaces WLAN0 to WLAN3. If you select From WAN in the Interface field, you can select a specific WAN connection (PVC0~PVC2) from which traffic is received.
Source	
IP Address	Select the check box and enter the source IP address in dotted decimal notation. A blank IP address means any source IP address.
Subnet Netmask/ Source Prefix Length	Enter the source subnet mask if you select IPv4 as the Ether Type . Enter the source prefix length if you select IPv6 as the Ether Type .
Port Range	If you select TCP/UDP , TCP or UDP in the IP protocol field, select the check box and enter the port number(s) of the source.
MAC Address	Select the check box and enter the source MAC address of the packet.
Mac Netmask	Type the mask for the specified MAC address to determine which bits a packet's MAC address should match. Enter "f" for each bit of the specified source MAC address that the traffic's MAC address should match. Enter "0" for the bit(s) of the matched traffic's MAC address, which can be of any hexadecimal character(s). For example, if you set the MAC address to 00:13:49:00:00:00 and the mask to ff:ff:ff:00:00:00, a packet with a MAC address of 00:13:49:12:34:56 matches this criteria.
Exclude	Select this option to exclude the packets that match the specified criteria from this classifier.
Destination	
IP Address	Select the check box and enter the source IP address in dotted decimal notation. A blank IP address means any destination IP address.
Subnet Netmask/ Destination Prefix Length	Enter the destination subnet mask if you select IPv4 as the Ether Type . Enter the destination prefix length if you select IPv6 as the Ether Type .
Port Range	If you select TCP/UDP , TCP or UDP in the IP Protocol field, select the check box and enter the port number(s) of the source.
MAC Address	Select the check box and enter the destination MAC address of the packet.

Table 47 QoS > Class Setup Add/Edit (continued)

LABEL	DESCRIPTION
Mac Netmask	Type the mask for the specified MAC address to determine which bits a packet's MAC address should match. Enter "f" for each bit of the specified source MAC address that the traffic's MAC address should match. Enter "0" for the bit(s) of the matched traffic's MAC address, which can be of any hexadecimal character(s). For example, if you set the MAC address to 00:13:49:00:00:00 and the mask to ff:ff:ff:00:00:00, a packet with a MAC address of 00:13:49:12:34:56 matches this criteria.
Exclude	Select this option to exclude the packets that match the specified criteria from this classifier.
Others	
IP Protocol	This field is available only when you select IPv4 or IPv6 in the Ether Type field. If you select IPv4 , select this option and select the protocol (service type) from TCP/UDP, TCP, UDP or ICMP . If you select IPv6 , select this option and select the protocol (service type) from TCP/UDP, TCP, UDP or ICMPv6 .
TCP ACK	This field is available only when you select TCP in the IP protocol field. If you select this option, the matched TCP packets must contain the ACK (Acknowledge) flag.
Packet Length	This field is available only when you select IPv4 or IPv6 in the Ether Type field. Select this option and enter the minimum and maximum packet length (from 46 to 1500) in the fields provided.
IPP/DS Field	Select IPP/TOS to specify an IP precedence range and type of services. Select DSCP to specify a DiffServ Code Point (DSCP) range.
IP Precedence Range	Enter a range from 0 to 7 for IP precedence. 0 is the lowest priority and 7 is the highest.
Type of Service	Select a type of service from the drop-down list box. Available options are: Normal service, Minimize delay, Maximize throughput, Maximize reliability and Minimize monetary cost .
DSCP Range	Select this option and specify a DSCP (DiffServ Code Point) number between 0 and 63 in the field provided.
802.1P	Select this option and select a priority level (between 0 and 7) from the drop-down list box. "0" is the lowest priority level and "7" is the highest.
VLAN ID	Select this option and enter the source VLAN ID in this field.
Exclude	Select this option to exclude the packets that match the specified criteria from this classifier.
Action	
Forward To	Select the interface through which traffic that matches the rule is forwarded out. If you select Unchange , the AMG1312-T Series forwards traffic of this class according to the default routing table. If traffic of this class comes from a WAN interface and is in a queue that forwards traffic through the LAN/WLAN interface, the AMG1312-T Series ignores the setting here.
IPP/DS Field	Select IPP/TOS to specify an IP precedence range and type of services. Select DSCP to specify a DiffServ Code Point (DSCP) range.
IP Precedence Mark	Enter a range from 0 to 7 to re-assign IP precedence to matched traffic. 0 is the lowest priority and 7 is the highest.

Table 47 QoS > Class Setup Add/Edit (continued)

LABEL	DESCRIPTION
Type Of Service Mark	Select a type of service to re-assign the priority level to matched traffic. Available options are: Normal service , Minimize delay , Maximize throughput , Maximize reliability and Minimize monetary cost .
DSCP Mark(0~63)	This field is available only when you select IP in the Ether Type field. If you select Mark , enter a DSCP value with which the AMG1312-T Series replaces the DSCP field in the packets. If you select Unchange , the AMG1312-T Series keep the DSCP field in the packets.
802.1Q Tag	If you select Remark , select a priority level (in the Ethernet Priority field) and enter a VLAN ID number (in the VLAN ID field) with which the AMG1312-T Series replaces the IEEE 802.1p priority field and VLAN ID of the frames. If you select Remove , the AMG1312-T Series deletes the VLAN ID of the frames before forwarding them out. If you select Add , the AMG1312-T Series treat all matched traffic untagged and add a second priority level and VLAN ID that you specify in the Ethernet Priority and VLAN ID fields. If you select Same , the AMG1312-T Series keep the Ethernet Priority and VLAN ID in the packets. To configure the Ethernet Priority, you can either select a priority number in the first drop-down list box (7 is the highest and 0 is the lowest priority) or select an application from the second drop-down list box which automatically maps to the corresponding priority number. (Key Net Traffic: 7; Voice: 6; Video: 5; IGMP: 4; Key Data: 3)
OK	Click OK to save your changes.
Cancel	Click Cancel to exit this screen without saving.

10.5 The QoS Game List Screen

Use this screen to give priority to traffic for specific games. Click **Network Setting > QoS > Game List** to open the screen as shown next.

Figure 68 Network Setting > QoS > Game List

Enable Game List

Call of Duty: Black Ops(PC) Call of Duty: Black Ops(PS3) Call of Duty: Black Ops(XBOX360)

Call of Duty: Modern Warfare 2(PC) Call of Duty: Modern Warfare 2(PS3) Call of Duty: World at War(PS3)

CounterStrike(PC) DiRT 2(PS3) FIFA 2010(PS3)

FIFA 2011(PS3) Pro Evolution Soccer 2011(PS3) Red Dead Redemption(PS3)

StarCraft2(PC) Uncharted 2: Among Thieves(PS3) Valve Steam Session(PC)

The following table describes the labels in this screen.

Table 48 Network Setting > QoS > Game List

LABEL	DESCRIPTION
Enable Game List	Select this to have QoS give the highest priority to traffic for the games you specify. This priority is higher than the other QoS queues. Select the games below.
Apply	Click this to save your changes.
Cancel	Click this to restore previously saved settings.

10.6 QoS Technical Reference

This section provides some technical background information about the topics covered in this chapter.

10.6.1 IEEE 802.1p

IEEE 802.1p specifies the user priority field and defines up to eight separate traffic types. The following table describes the traffic types defined in the IEEE 802.1d standard (which incorporates the 802.1p).

Table 49 IEEE 802.1p Priority Level and Traffic Type

PRIORITY LEVEL	TRAFFIC TYPE
Level 7	Typically used for network control traffic such as router configuration messages.
Level 6	Typically used for voice traffic that is especially sensitive to jitter (jitter is the variations in delay).
Level 5	Typically used for video that consumes high bandwidth and is sensitive to jitter.
Level 4	Typically used for controlled load, latency-sensitive traffic such as SNA (Systems Network Architecture) transactions.
Level 3	Typically used for "excellent effort" or better than best effort and would include important business traffic that can tolerate some delay.
Level 2	This is for "spare bandwidth".
Level 1	This is typically used for non-critical "background" traffic such as bulk transfers that are allowed but that should not affect other applications and users.
Level 0	Typically used for best-effort traffic.

10.6.2 IP Precedence

Similar to IEEE 802.1p prioritization at layer-2, you can use IP precedence to prioritize packets in a layer-3 network. IP precedence uses three bits of the eight-bit ToS (Type of Service) field in the IP header. There are eight classes of services (ranging from zero to seven) in IP precedence. Zero is the lowest priority level and seven is the highest.

10.6.3 Automatic Priority Queue Assignment

If you enable QoS on the AMG1312-T Series, the AMG1312-T Series can automatically base on the IEEE 802.1p priority level, IP precedence and/or packet length to assign priority to traffic which does not match a class.

The following table shows you the internal layer-2 and layer-3 QoS mapping on the AMG1312-T Series. On the AMG1312-T Series, traffic assigned to higher priority queues gets through faster while traffic in lower index queues is dropped if the network is congested.

Table 50 Internal Layer2 and Layer3 QoS Mapping

PRIORITY QUEUE	LAYER 2	LAYER 3		
	IEEE 802.1P USER PRIORITY (ETHERNET PRIORITY)	TOS (IP PRECEDENCE)	DSCP	IP PACKET LENGTH (BYTE)
0	1	0	000000	
1	2			
2	0	0	000000	>1100
3	3	1	001110 001100 001010 001000	250~1100
4	4	2	010110 010100 010010 010000	
5	5	3	011110 011100 011010 011000	<250
6	6	4	100110 100100 100010 100000	
		5	101110 101000	
7	7	6	110000	
		7	111000	

Network Address Translation (NAT)

11.1 Overview

This chapter discusses how to configure NAT on the AMG1312-T Series. NAT (Network Address Translation - NAT, RFC 1631) is the translation of the IP address of a host in a packet, for example, the source address of an outgoing packet, used within one network to a different IP address known within another network.

11.1.1 What You Can Do in the NAT Screens

- Use the **General** screen ([Section 11.2 on page 148](#)) to activate/deactivate NAT for the default WAN connection (PVC0).
- Use the **Port Forwarding** screen ([Section 11.3 on page 149](#)) to configure forward incoming service requests to the server(s) on your local network.
- Use the **DMZ** screen to configure a default server ([Section 11.4 on page 152](#)).
- Use the **ALG** screen to enable and disable the NAT and SIP (VoIP) ALG in the AMG1312-T Series ([Section 11.5 on page 152](#)).

11.1.2 What You Need To Know About NAT

Inside/Outside

Inside/outside denotes where a host is located relative to the AMG1312-T Series, for example, the computers of your subscribers are the inside hosts, while the web servers on the Internet are the outside hosts.

Global/Local

Global/local denotes the IP address of a host in a packet as the packet traverses a router, for example, the local address refers to the IP address of a host when the packet is in the local network, while the global address refers to the IP address of the host when the same packet is traveling in the WAN side.

NAT

In the simplest form, NAT changes the source IP address in a packet received from a subscriber (the inside local address) to another (the inside global address) before forwarding the packet to the WAN side. When the response comes back, NAT translates the destination address (the inside global address) back to the inside local address before forwarding it to the original inside host.

Port Forwarding

A port forwarding set is a list of inside (behind NAT on the LAN) servers, for example, web or FTP, that you can make visible to the outside world even though NAT makes your whole inside network appear as a single computer to the outside world.

Finding Out More

See [Section 11.6 on page 153](#) for advanced technical information on NAT.

11.2 The NAT General Screen

Use this screen to activate NAT for the default WAN connection (PVC0). Click **Network Setting > NAT** to open the following screen.

Note: You must create an IP filter rule in addition to setting up NAT, to allow traffic from the WAN to be forwarded through the AMG1312-T Series.

Figure 69 Network Setting > NAT > General

The screenshot shows a configuration window for NAT. At the top, there is a checked checkbox labeled 'Active'. Below it is a text input field labeled 'Max NAT/Firewall Session Per User' containing the number '3072'. A 'Note' section follows, containing the text: 'Maximum number of NAT/firewall sessions for the router is 8192. To remove the per user limit, set to 8192.' At the bottom right, there are two buttons: 'Apply' and 'Cancel'.

The following table describes the labels in this screen.

Table 51 Network Setting > NAT > General

LABEL	DESCRIPTION
Active	Select this check box to enable NAT.
Max NAT/Firewall Session Per User	<p>When computers use peer to peer applications, such as file sharing applications, they need to establish NAT sessions. If you do not limit the number of NAT sessions a single client can establish, this can result in all of the available NAT sessions being used. In this case, no additional NAT sessions can be established, and users may not be able to access the Internet.</p> <p>Each NAT session establishes a corresponding firewall session. Use this field to limit the number of NAT/Firewall sessions client computers can establish through the AMG1312-T Series.</p> <p>If your network has a small number of clients using peer to peer applications, you can raise this number to ensure that their performance is not degraded by the number of NAT sessions they can establish. If your network has a large number of users using peer to peer applications, you can lower this number to ensure no single client is exhausting all of the available NAT sessions.</p>
Apply	Click this to save your changes.
Cancel	Click this to restore your previously saved settings.

11.3 The Port Forwarding Screen

Use this screen to forward incoming service requests to the server(s) on your local network.

You may enter a single port number or a range of port numbers to be forwarded, and the local IP address of the desired server. The port number identifies a service; for example, web service is on port 80 and FTP on port 21. In some cases, such as for unknown services or where one server can support more than one service (for example both FTP and web service), it might be better to specify a range of port numbers. You can allocate a server IP address that corresponds to a port or a range of ports.

The most often used port numbers and services are shown in [Appendix F on page 286](#). Please refer to RFC 1700 for further information about port numbers.

Note: Many residential broadband ISP accounts do not allow you to run any server processes (such as a Web or FTP server) from your location. Your ISP may periodically check for servers and may suspend your account if it discovers any active services at your location. If you are unsure, refer to your ISP.

Default Server IP Address

In addition to the servers for specified services, NAT supports a default server IP address. A default server receives packets from ports that are not specified in this screen.

Note: If you do not assign a **Default Server** IP address, the AMG1312-T Series discards all packets received for ports that are not specified here or in the remote management setup.

Configuring Servers Behind Port Forwarding (Example)

Let's say you want to assign ports 21-25 to one FTP, Telnet and SMTP server (**A** in the example), port 80 to another (**B** in the example) and assign a default server IP address of 192.168.1.35 to a third (**C** in the example). You assign the LAN IP addresses and the ISP assigns the WAN IP address. The NAT network appears as a single host on the Internet.

Figure 70 Multiple Servers Behind NAT Example

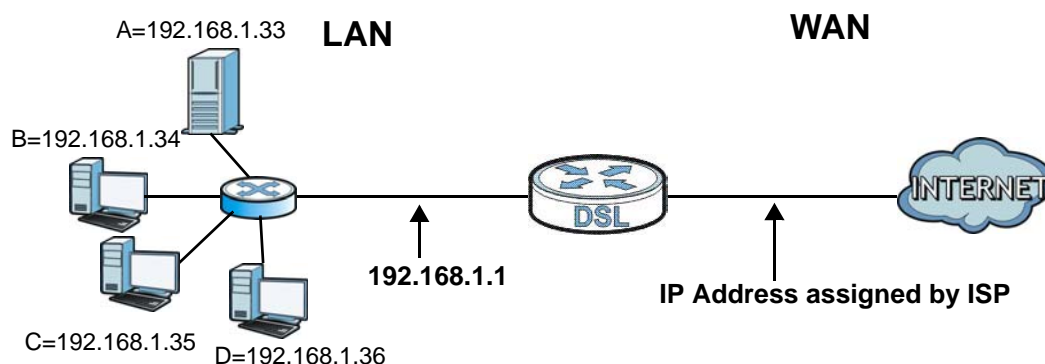

11.3.1 Configuring the Port Forwarding Screen

Click **Network Setting > NAT > Port Forwarding** to open the following screen.

See [Appendix F on page 286](#) for port numbers commonly used for particular services.

Note: Make sure NAT is activated on the WAN connection before you configure a port forwarding rule for it. For the default WAN connection (PVC0), activate NAT in the **Network Setting > NAT > General** screen. For other WAN connections (PVC1~PVC7), activate NAT for an individual WAN connection in the **Broadband > More Connections > Edit** screen.

Figure 71 Network Setting > NAT > Port Forwarding

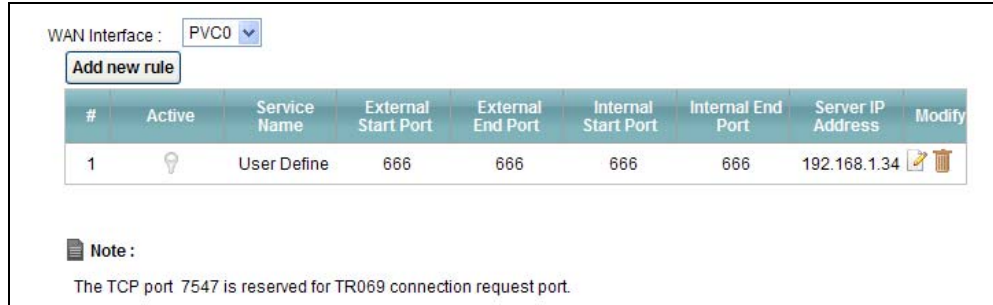

WAN Interface : PVC0

Add new rule

#	Active	Service Name	External Start Port	External End Port	Internal Start Port	Internal End Port	Server IP Address	Modify
1	<input checked="" type="checkbox"/>	User Define	666	666	666	666	192.168.1.34	

Note :
The TCP port 7547 is reserved for TR069 connection request port.

The following table describes the fields in this screen.

Table 52 Network Setting > NAT > Port Forwarding

LABEL	DESCRIPTION
WAN Interface	Select a WAN connection for which you want to configure a port forwarding rule. A 3G option is available only when you enable the 3G backup function.
Add new rule	Click this button to add a rule to the table below.
#	This is the rule index number (read-only).
Active	This field indicates whether the rule is active or not. Clear the check box to disable the rule. Select the check box to enable it.
Service Name	This is a service's name.
External Start Port	This is the first port number of a port range that incoming service requests may use to access the service in your local network.
External End Port	This is the last port number of a port range that incoming service requests may use to access the service in your local network.
Internal Start Port	This is the starting port number that the device translates for the service in your local network.
Internal End Port	This is the ending port number that the device translates for the service in your local network.
Server IP Address	This is the server's IP address in your local network.
Modify	Click the edit icon to go to the screen where you can edit the port forwarding rule. Click the delete icon to delete an existing port forwarding rule. Note that subsequent address mapping rules move up by one when you take this action.

11.3.2 Port Forwarding Rule Add/Edit

Use this screen to add or edit a port forwarding rule. Click the **Add new rule** button or a rule's edit icon in the **Port Forwarding** screen to display the screen as shown next.

Figure 72 Network Setting > NAT > Port Forwarding: Add/Edit

The following table describes the fields in this screen.

Table 53 Network Setting > NAT > Port Forwarding: Edit

LABEL	DESCRIPTION
Active	Click this check box to enable the rule.
Service Name	Enter a name to identify this port-forwarding rule.
External Start Port	Enter a port number in this field. To forward only one port, enter the port number again in the End Port field. To forward a series of ports, enter the start port number here and the end port number in the End Port field.
External End Port	Enter a port number in this field. To forward only one port, enter the port number in the Start Port field above and then enter it again in this field. To forward a series of ports, enter the last port number in a series that begins with the port number in the Start Port field above.
Server IP Address	Enter the IP address of the server in your local network.
Trigger Protocol	Select the protocol of the service, TCP , UDP or ALL (TCP+UDP).
Open Start Port	Enter the first port number here to which you want the device to translate the incoming port. For a range of ports, you only need to enter the first number of the range to which you want the incoming ports translated, the device automatically calculates the last port of the translated port range.
Open End Port	Enter the last port number here to which you want the device to translate the incoming port. For a range of ports, you only need to enter the first number of the range to which you want the incoming ports translated, the device automatically calculates the last port of the translated port range.
Back	Click this to return to the previous screen without saving.
Apply	Click this to save your changes.
Cancel	Click this to restore your previously saved settings.

11.4 The DMZ Screen

If you need to allow packets from a specific WAN connection to your local network, NAT supports a default server IP address. A default server receives packets from the specified WAN connection and the ports that are not specified in the **NAT Port Forwarding Setup** screen.

Figure 73 Network Setting > NAT > DMZ

WAN Interface : PVC0

Default Server Address : 0.0.0.0

Note :
 Enter IP address and click 'Apply' to activate the DMZ host.
 Input 0.0.0.0 in IP address field and click 'Apply' to deactivate the DMZ host.

Apply Cancel

The following table describes the fields in this screen.

Table 54 Network Setting > NAT > DMZ

LABEL	DESCRIPTION
WAN Interface	Select a WAN PVC connection (PVC0~PVC7) from which you want to forward the traffic to the specified default server.
Default Server Address	Enter the IP address of the default server which receives packets from ports that are not specified in the NAT > Port Forwarding screen. Note: If you do not assign a Default Server Address , the AMG1312-T Series discards all packets received for ports that are not specified in the NAT Port Forwarding screen.
Apply	Click Apply to save your changes.
Cancel	Click Cancel to restore your previously saved settings.

11.5 The ALG Screen

Some NAT routers may include a SIP Application Layer Gateway (ALG). A SIP ALG allows SIP calls to pass through NAT by examining and translating IP addresses embedded in the data stream. When the AMG1312-T Series registers with the SIP register server, the SIP ALG translates the AMG1312-T Series's private IP address inside the SIP data stream to a public IP address. You do not need to use STUN or an outbound proxy if your AMG1312-T Series is behind a SIP ALG.

Use this screen to enable and disable the SIP (VoIP) ALG in the AMG1312-T Series. To access this screen, click **Network Settings > NAT > ALG**.

Figure 74 Network Setting > NAT > ALG

The following table describes the fields in this screen.

Table 55 Network Setting > NAT > ALG

LABEL	DESCRIPTION
ALG	Enable the SIP ALG to make sure SIP (VoIP) works correctly with port-forwarding and address-mapping rules.
Apply	Click Apply to save your changes.
Cancel	Click Cancel to restore your previously saved settings.

11.6 NAT Technical Reference

This chapter contains more information regarding NAT.

11.6.1 NAT Definitions

Inside/outside denotes where a host is located relative to the AMG1312-T Series, for example, the computers of your subscribers are the inside hosts, while the web servers on the Internet are the outside hosts.

Global/local denotes the IP address of a host in a packet as the packet traverses a router, for example, the local address refers to the IP address of a host when the packet is in the local network, while the global address refers to the IP address of the host when the same packet is traveling in the WAN side.

Note that inside/outside refers to the location of a host, while global/local refers to the IP address of a host used in a packet. Thus, an inside local address (ILA) is the IP address of an inside host in a packet when the packet is still in the local network, while an inside global address (IGA) is the IP address of the same inside host when the packet is on the WAN side. The following table summarizes this information.

Table 56 NAT Definitions

ITEM	DESCRIPTION
Inside	This refers to the host on the LAN.
Outside	This refers to the host on the WAN.
Local	This refers to the packet address (source or destination) as the packet travels on the LAN.
Global	This refers to the packet address (source or destination) as the packet travels on the WAN.

NAT never changes the IP address (either local or global) of an outside host.

11.6.2 What NAT Does

In the simplest form, NAT changes the source IP address in a packet received from a subscriber (the inside local address) to another (the inside global address) before forwarding the packet to the WAN side. When the response comes back, NAT translates the destination address (the inside global address) back to the inside local address before forwarding it to the original inside host. Note that the IP address (either local or global) of an outside host is never changed.

The global IP addresses for the inside hosts can be either static or dynamically assigned by the ISP. In addition, you can designate servers, for example, a web server and a telnet server, on your local network and make them accessible to the outside world. If you do not define any servers (for Many-to-One and Many-to-Many Overload mapping – see [Table 57 on page 156](#)), NAT offers the additional benefit of firewall protection. With no servers defined, your AMG1312-T Series filters out all incoming inquiries, thus preventing intruders from probing your network. For more information on IP address translation, refer to *RFC 1631, The IP Network Address Translator (NAT)*.

11.6.3 How NAT Works

Each packet has two addresses – a source address and a destination address. For outgoing packets, the ILA (Inside Local Address) is the source address on the LAN, and the IGA (Inside Global Address) is the source address on the WAN. For incoming packets, the ILA is the destination address on the LAN, and the IGA is the destination address on the WAN. NAT maps private (local) IP addresses to globally unique ones required for communication with hosts on other networks. It replaces the original IP source address (and TCP or UDP source port numbers for Many-to-One and Many-to-Many Overload NAT mapping) in each packet and then forwards it to the Internet. The AMG1312-T Series keeps track of the original addresses and port numbers so incoming reply packets can have their original values restored. The following figure illustrates this.

Figure 75 How NAT Works

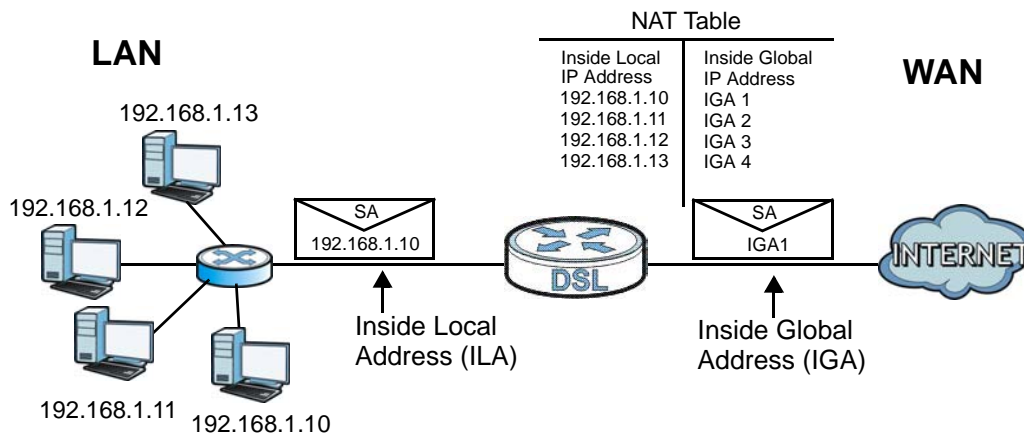

11.6.4 NAT Application

The following figure illustrates a possible NAT application, where three inside LANs (logical LANs using IP alias) behind the AMG1312-T Series can communicate with three distinct WAN networks.

Figure 76 NAT Application With IP Alias

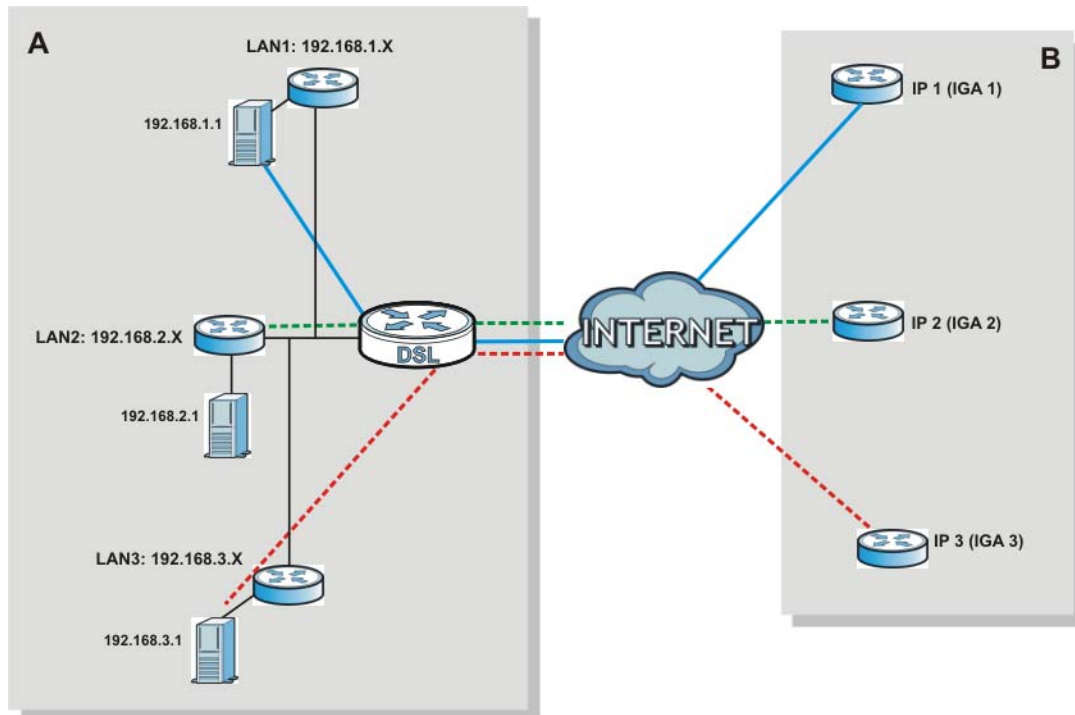

11.6.5 NAT Mapping Types

NAT supports five types of IP/port mapping. They are:

- **One to One:** In One-to-One mode, the AMG1312-T Series maps one local IP address to one global IP address.
- **Many to One:** In Many-to-One mode, the AMG1312-T Series maps multiple local IP addresses to one global IP address. This is equivalent to SUA (for instance, PAT, port address translation), ZyXEL's Single User Account feature that previous ZyXEL routers supported (the **SUA Only** option in today's routers).
- **Many to Many Overload:** In Many-to-Many Overload mode, the AMG1312-T Series maps the multiple local IP addresses to shared global IP addresses.
- **Many-to-Many No Overload:** In Many-to-Many No Overload mode, the AMG1312-T Series maps each local IP address to a unique global IP address.
- **Server:** This type allows you to specify inside servers of different services behind the NAT to be accessible to the outside world.

Port numbers do NOT change for **One-to-One** and **Many-to-Many No Overload** NAT mapping types.

The following table summarizes these types.

Table 57 NAT Mapping Types

TYPE	IP MAPPING
One-to-One	ILA1 ↔ IGA1
Many-to-One (SUA/PAT)	ILA1 ↔ IGA1 ILA2 ↔ IGA1 ...
Many-to-Many Overload	ILA1 ↔ IGA1 ILA2 ↔ IGA2 ILA3 ↔ IGA1 ILA4 ↔ IGA2 ...
Many-to-Many No Overload	ILA1 ↔ IGA1 ILA2 ↔ IGA2 ILA3 ↔ IGA3 ...
Server	Server 1 IP ↔ IGA1 Server 2 IP ↔ IGA1 Server 3 IP ↔ IGA1

Port Binding

12.1 Overview

This chapter describes how to configure the port binding settings.

Port binding allows you to aggregate port connections into logical groups. You may bind WAN PVCs to Ethernet ports and WLANs to specify how traffic is forwarded. Different ATM QoS settings can be specified for each WAN PVC to meet bandwidth requirements for the type of traffic to be transferred.

For example, three port binding groups could be created on the device (R1) for three different WAN PVC connections. The first PVC (PVC0) is for non time-sensitive data traffic. The second and third PVCs (PVC1 and PVC2) are for time sensitive Media-On-Demand (MOD) video traffic and VoIP traffic, respectively.

Figure 77 Port Binding Groups

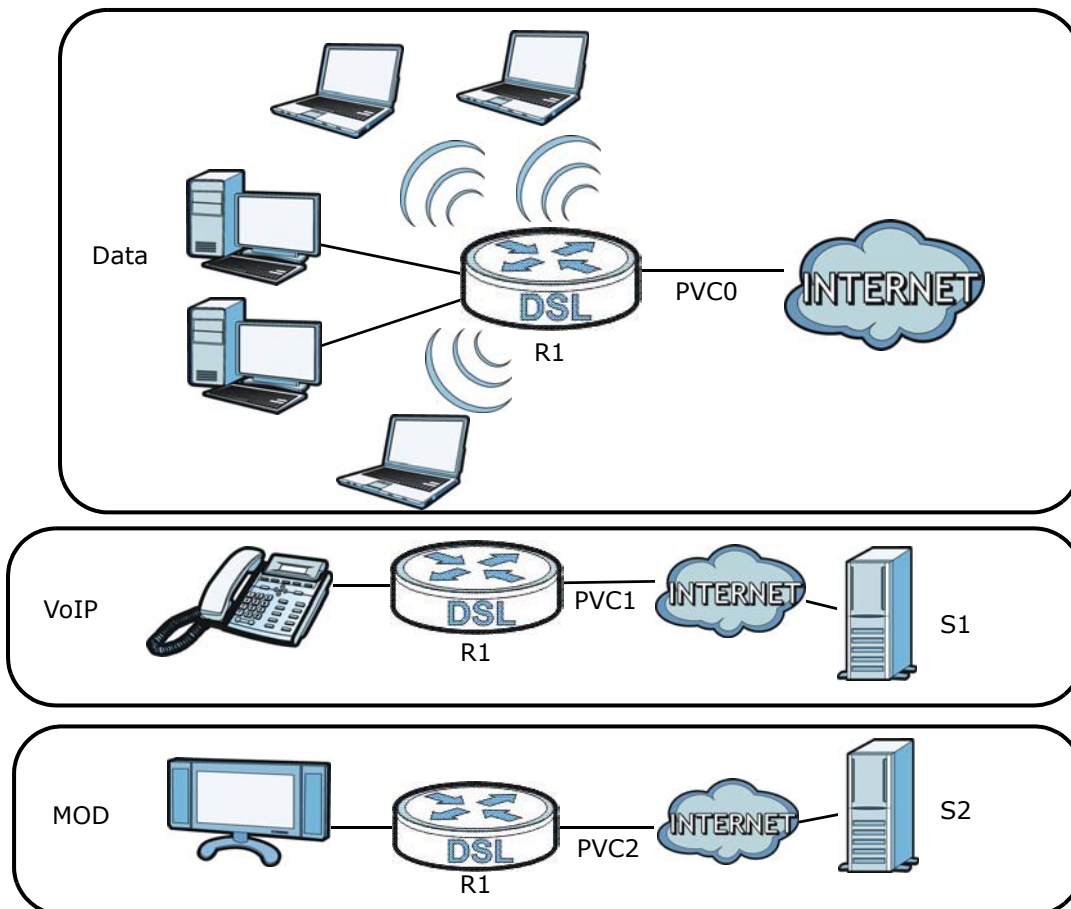

If a WAN PVC is bound to an ethernet port, traffic from the ethernet port will only be forwarded through the specified WAN PVC and vice versa. If a port is not in a port binding group, traffic to and from the port will be forwarded according to the routing table. See the tutorial section ([Section on page 34](#)) for more details on configuring port binding for multiple WAN connections.

12.1.1 What You Can Do in the Port Binding Screens

- Use the **General** screen ([Section 12.3 on page 158](#)) to activate port binding.
- Use the **Port Binding** screen ([Section 12.3 on page 158](#)) to set up port binding groups.
- Use the **Port Binding Summary** screen ([Section 12.3.1 on page 159](#)) to view configured port binding groups.

12.2 The Port Binding General Screen

Use this screen to activate port binding and set up port binding groups. Click **Network Setting > Port Binding** to display the following screen.

Figure 78 Network Setting > Port Binding



The following table describes the labels in this screen.

Table 58 Network Setting > Port Binding

LABEL	DESCRIPTION
Activated Port Binding	Activate or deactivate the port binding feature.
Apply	Add the selected port binding group configuration.

12.3 The Port Binding Screen

Use this screen to set up port binding groups. Click **Network Setting > Port Binding > Port Binding** to display the following screen.

Figure 79 Network Setting > Port Binding > Port Binding

The following table describes the labels in this screen.

Table 59 Network Setting > Port Binding > Port Binding

LABEL	DESCRIPTION
Port Binding	
Active	Activate or deactivate port binding for the port binding group.
Group Index	Select the index number for the port binding group. When a port is assigned to a port binding group, traffic will be forwarded to the other ports in the group, but not to ports in other groups. If a port is not included in any groups, traffic will be forwarded according to the routing table.
ATM VCs	Select the ATM VC (PVC) to include in the port binding group. Each ATM VC can only be bound to one group.
Ethernet	Select the Ethernet (Eth) ports to include in the port binding group. Each Ethernet port can only be bound to one group.
Wireless LAN	Select the WLAN (AP) connection to include in the port binding group. Additional APs can be enabled on the More AP screen (Section 7.3 on page 94).
Group Summary	
Port Binding Summary	Click this to view a summary of configured port binding groups.
Apply	Add the selected port binding group configuration.
Delete	Delete the selected port binding group configuration.
Cancel	Click this to restore your previously saved settings.

12.3.1 Port Binding Summary Screen

Use this screen to view configured port binding groups.

In the **Port Binding** screen, click the **Port Binding Summary** button in the **Group Summary** section to display the following screen.

Figure 80 Network Setting > Port Binding > Port Binding Summary

Group ID	Group Port
Group0	PVC1,eth2,AP0,
Group1	PVC0,eth1,

Example

The following table describes the labels in this screen.

Table 60 Network Setting > Port Binding > Port Binding Summary

LABEL	DESCRIPTION
Group ID	This field displays the group index number.
Group port	This field displays the ports included in the group.

Dynamic DNS Setup

13.1 Overview

Dynamic DNS allows you to update your current dynamic IP address with one or many dynamic DNS services so that anyone can contact you (in NetMeeting, CU-SeeMe, etc.). You can also access your FTP server or Web site on your own computer using a domain name (for instance myhost.dhs.org, where myhost is a name of your choice) that will never change instead of using an IP address that changes each time you reconnect. Your friends or relatives will always be able to call you even if they don't know your IP address.

First of all, you need to have registered a dynamic DNS account with www.dyndns.org. This is for people with a dynamic IP from their ISP or DHCP server that would still like to have a domain name. The Dynamic DNS service provider will give you a password or key.

13.1.1 What You Can Do in the DDNS Screen

Use the **Dynamic DNS** screen ([Section 13.2 on page 161](#)) to enable DDNS and configure the DDNS settings on the AMG1312-T Series.

13.1.2 What You Need To Know About DDNS

DYNDNS Wildcard

Enabling the wildcard feature for your host causes *.yourhost.dyndns.org to be aliased to the same IP address as yourhost.dyndns.org. This feature is useful if you want to be able to use, for example, www.yourhost.dyndns.org and still reach your hostname.

If you have a private WAN IP address, then you cannot use Dynamic DNS.

13.2 The Dynamic DNS Screen

Use this screen to change your AMG1312-T Series's DDNS. Click **Network Setting > Dynamic DNS**. The screen appears as shown.

Figure 81 Network Setting > Dynamic DNS

The following table describes the fields in this screen.

Table 61 Network Setting > Dynamic DNS

LABEL	DESCRIPTION
Dynamic DNS Setup	
Active Dynamic DNS	Select this check box to use dynamic DNS.
Service Provider	This is the website of your Dynamic DNS service provider.
Host Name	Type the domain name assigned to your AMG1312-T Series by your Dynamic DNS provider. You can specify up to two host names in the field separated by a comma (",").
Username	Type your user name.
Password	Type the password assigned to you.
Enable Wildcard Option	Select the check box to enable DynDNS Wildcard.
Apply	Click this to save your changes.
Cancel	Click this to restore your previously saved settings.

14.1 Overview

This chapter introduces three types of filters supported by the AMG1312-T Series. You can configure rules to restrict traffic by IP addresses, MAC addresses, IPv6 addresses and/or URLs.

14.1.1 What You Can Do in the Filter Screens

- Use the **IP/MAC Filter** screen ([Section 14.2 on page 163](#)) to create IP and MAC filter rules.
- Use the **IPv6/MAC Filter** screen ([Section 14.3 on page 166](#)) to create IPv6 and MAC filter rules.

14.1.2 What You Need to Know About Filtering

URL

The URL (Uniform Resource Locator) identifies and helps locates resources on a network. On the Internet the URL is the web address that you type in the address bar of your Internet browser, for example "http://www.zyxel.com".

URL and IP Filter Structure

The URL, IP and IPv6 filters have individual rule indexes. The AMG1312-T Series allows you to configure each type of filter with its own respective set of rules.

14.2 The IP/MAC Filter Screen

Use this screen to create and apply IP and MAC filters. Click **Security > Filter > IP/MAC Filter**. The screen appears as shown.

Figure 82 Security > Filter > IP/MAC Filter

Rule Type

Rule Type selection:

IP / MAC Filter Rule Editing

IP / MAC Filter Rule Index:

Active: Yes No

Interface:

Direction:

Rule Type:

Source IP Address: (0.0.0.0 means Dont care)

Subnet Mask:

Port Number: (0 means Dont care)

Destination IP Address: (0.0.0.0 means Dont care)

Subnet Mask:

Port Number:

Protocol:

IP / MAC Filter Listing

IP / MAC Filter Rule Index:

#	Active	Interface	Direction	Src IP/Mask	Dest IP/Mask	Mac Address	Src Port	Dest Port	Protocol
1	No	PVC0	Incoming	0.0.0.0/ 0.0.0.0	0.0.0.0/ 0.0.0.0	N/A	0	0	TCP

The following table describes the labels in this screen.

Table 62 Security > Filter > IP/MAC Filter

LABEL	DESCRIPTION
Rule Type	
Rule Type selection	Select White List to specify traffic to allow and Black List to specify traffic to disallow.
IP / MAC Filter Rule Editing	
IP / MAC Filter Rule Index	Select the index number of the filter rule.
Active	Use this field to enable or disable the filter rule.
Interface	Select the PVC to which to apply the filter.
Direction	Apply the filter to Incoming or Outgoing traffic direction.
Rule Type	Select IP or MAC type to configure the rule. Use the IP Filter to block or allow traffic by IP addresses. Use the MAC Filter to block or allow traffic by MAC address.
Source IP Address	Enter the source IP address of the packets you wish to filter. This field is ignored if it is 0.0.0.0.
Subnet Mask	Enter the IP subnet mask for the source IP address
Port Number	Enter the source port of the packets that you wish to filter. The range of this field is 0 to 65535. This field is ignored if it is 0.
Destination IP Address	Enter the destination IP address of the packets you wish to filter. This field is ignored if it is 0.0.0.0.

Table 62 Security > Filter > IP/MAC Filter (continued)

LABEL	DESCRIPTION
Subnet Mask	Enter the IP subnet mask for the destination IP address.
Port Number	Enter the destination port of the packets that you wish to filter. The range of this field is 0 to 65535. This field is ignored if it is 0.
Protocol	Select ICMP , TCP or UDP for the upper layer protocol.
IP / MAC Filter Listing	
IP / MAC Filter Rule Index	Select the index number of the filter set from the drop-down list box.
#	This is the index number of the rule in a filter set.
Active	This field shows whether the rule is activated.
Interface	This is the interface that the filter set applies to.
Direction	The filter set applies to this traffic direction.
Src IP/Mask	This is the source IP address and subnet mask when you select IP as the rule type.
Dest IP/Mask	This is the destination IP address and subnet mask.
Mac Address	This is the MAC address of the packets being filtered.
Src Port	This is the source port number.
Dest Port	This is the destination port number.
Protocol	This is the upper layer protocol.
Apply	Click this to apply your changes.
Delete	Click this to remove the filter rule.
Cancel	Click this to restore your previously saved settings.

14.3 IPv6/MAC Filter

Use this screen to create and apply IPv6 filters. Click **Security > Filter > IPv6/MAC Filter**. The screen appears as shown.

Figure 83 Security > Filter > IPv6/MAC Filter

Rule Type

Rule Type selection: White List

IPv6 / MAC Filter Rule Editing

IPv6 / MAC Filter Rule Index: 1

Active: Yes No

Interface: PVC0

Direction: Incoming

Rule Type: IP

Source IP Address:

Source Prefix Length:

Destination IPv6 Address:

Destination Prefix Length:

ICMPv6 Type: 1 / Destination Unreachable (0 - no route to destination)

Protocol: ICMPv6

IPv6 / MAC Filter Listing

IPv6 / MAC Filter Rule Index: 1

#	Active	Interface	Direction	ICMPv6 Type	Src IP/Prefix length	Dest IP/Prefix length	Mac Address	Protocol
1	No	PVC0	Incoming	N/A	N/A/N/A	N/A/N/A	N/A	ICMPv6

Apply Delete Cancel

The following table describes the labels in this screen.

Table 63 Security > Filter > IPv6/MAC Filter

LABEL	DESCRIPTION
Rule Type	
Rule Type selection	Select White List to specify traffic to allow and Black List to specify traffic to block.
IPv6 / MAC Filter Rule Editing	
IPv6 / MAC Filter Rule Index	Select the index number of the filter rule.
Active	Use this field to enable or disable the filter rule.
Interface	Select the PVC to which to apply the filter.
Direction	Apply the filter to Incoming or Outgoing traffic direction.
Rule Type	Select IP or MAC type to configure the rule. Use the IP Filter to block or allow traffic by IPv6 addresses. Use the MAC Filter to block or allow traffic by MAC address.
Source IP Address	Enter the source IPv6 address of the packets you wish to filter. This field is ignored if it is ::.
Source Prefix Length	Enter the prefix length for the source IPv6 address
Destination IPv6 Address	Enter the destination IPv6 address of the packets you wish to filter. This field is ignored if it is ::.

Table 63 Security > Filter > IPv6/MAC Filter (continued)

LABEL	DESCRIPTION
Destination Prefix Length	Enter the prefix length for the destination IPv6 address.
ICMPv6 Type	<p>Select the ICMPv6 message type to filter. The following message types can be selected:</p> <p>1 / Destination Unreachable: 0 - no route to destination; 1 - communication with destination administratively prohibited; 3 - address unreachable; 4 - port unreachable</p> <p>2 / Packet Too Big</p> <p>3 / Time Exceeded: 0 - hop limit exceeded in transit; 1 - fragment reassembly time exceeded</p> <p>4 / Parameter Problem: 0 - erroneous header field encountered; 1 - unrecognized Next Header type encountered; 2 - unrecognized IPv6 option encountered</p> <p>128 / Echo Request</p> <p>129 / Echo Response</p> <p>130 / Listener Query - Multicast listener query</p> <p>131 / Listener Report - Multicast listener report</p> <p>132 / Listener Done - Multicast listener done</p> <p>143 / Listener Report v2 - Multicast listener report v2</p> <p>133 / Router Solicitation</p> <p>134 / Router Advertisement</p> <p>135 / Neighbor Solicitation</p> <p>136 / Neighbor Advertisement</p> <p>137 / Redirect - Redirect message</p>
Protocol	This is the (upper layer) protocol that defines the service to which this rule applies. By default it is ICMPv6.
IPv6 / MAC Filter Listing	
IPv6 / MAC Filter Rule Index	Select the index number of the filter set from the drop-down list box.
#	This is the index number of the rule in a filter set.
Active	This field shows whether the rule is activated.
Interface	This is the interface that the rule applies to.
Direction	The filter set applies to this traffic direction.
ICMPv6 Type	The ICMPv6 message type to filter.
Src IP/PrefixLength	This displays the source IPv6 address and prefix length.
Dest IP/PrefixLength	This displays the destination IPv6 address and prefix length.
Mac Address	This is the MAC address of the packets being filtered.
Protocol	This is the (upper layer) protocol that defines the service to which this rule applies. By default it is ICMPv6.
Apply	Click this to apply your changes.
Delete	Click this to remove the filter rule.
Cancel	Click this to restore your previously saved settings.

15.1 Overview

This chapter shows you how to enable the AMG1312-T Series firewall. Use the firewall to protect your AMG1312-T Series and network from attacks by hackers on the Internet and control access to it. The firewall:

- allows traffic that originates from your LAN computers to go to all other networks.
- blocks traffic that originates on other networks from going to the LAN.
- blocks SYN and port scanner attacks.

By default, the AMG1312-T Series blocks DDOS, LAND and Ping of Death attacks whether the firewall is enabled or disabled.

The following figure illustrates the firewall action. User **A** can initiate an IM (Instant Messaging) session from the LAN to the WAN (1). Return traffic for this session is also allowed (2). However other traffic initiated from the WAN is blocked (3 and 4).

Figure 84 Default Firewall Action

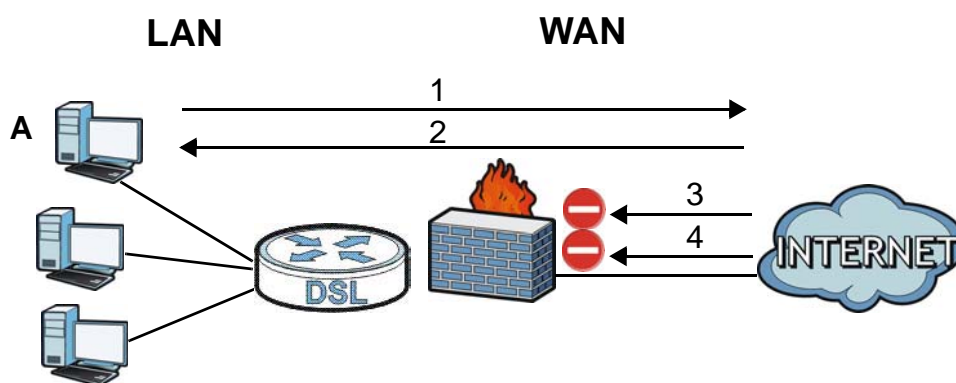

15.1.1 What You Can Do in the Firewall Screens

- Use the **General** screen ([Section 15.2 on page 170](#)) to select the firewall protection level on the AMG1312-T Series.
- Use the **Default Action** screen ([Section 15.3 on page 171](#)) to set the default action that the firewall takes on packets that do not match any of the firewall rules.
- Use the **Rules** screen ([Section 15.4 on page 173](#)) to view the configured firewall rules and add, edit or remove a firewall rule.
- Use the **Dos** screen ([Section 15.5 on page 179](#)) to set the thresholds that the AMG1312-T Series uses to determine when to start dropping sessions that do not become fully established (half-open sessions).

15.1.2 What You Need to Know About Firewall

SYN Attack

A SYN attack floods a targeted system with a series of SYN packets. Each packet causes the targeted system to issue a SYN-ACK response. While the targeted system waits for the ACK that follows the SYN-ACK, it queues up all outstanding SYN-ACK responses on a backlog queue. SYN-ACKs are moved off the queue only when an ACK comes back or when an internal timer terminates the three-way handshake. Once the queue is full, the system will ignore all incoming SYN requests, making the system unavailable for legitimate users.

DoS

Denials of Service (DoS) attacks are aimed at devices and networks with a connection to the Internet. Their goal is not to steal information, but to disable a device or network so users no longer have access to network resources. The AMG1312-T Series is pre-configured to automatically detect and thwart all known DoS attacks.

DDoS

A Distributed DoS (DDoS) attack is one in which multiple compromised systems attack a single target, thereby causing denial of service for users of the targeted system.

LAND Attack

In a Local Area Network Denial (LAND) attack, hackers flood SYN packets into the network with a spoofed source IP address of the target system. This makes it appear as if the host computer sent the packets to itself, making the system unavailable while the target system tries to respond to itself.

Ping of Death

Ping of Death uses a "ping" utility to create and send an IP packet that exceeds the maximum 65,536 bytes of data allowed by the IP specification. This may cause systems to crash, hang or reboot.

SPI

Stateful Packet Inspection (SPI) tracks each connection crossing the firewall and makes sure it is valid. Filtering decisions are based not only on rules but also context. For example, traffic from the WAN may only be allowed to cross the firewall in response to a request from the LAN.

RFC 4890 SPEC Traffic

RFC 4890 specifies the filtering policies for ICMPv6 messages. This is important for protecting against security threats including DoS, probing, redirection attacks and renumbering attacks that can be carried out through ICMPv6. Since ICMPv6 error messages are critical for establishing and maintaining communications, filtering policy focuses on ICMPv6 informational messages.

Anti-Probing

If an outside user attempts to probe an unsupported port on your AMG1312-T Series, an ICMP response packet is automatically returned. This allows the outside user to know the AMG1312-T Series exists. The AMG1312-T Series supports anti-probing, which prevents the ICMP response packet from being sent. This keeps outsiders from discovering your AMG1312-T Series when unsupported ports are probed.

ICMP

Internet Control Message Protocol (ICMP) is a message control and error-reporting protocol between a host server and a gateway to the Internet. ICMP uses Internet Protocol (IP) datagrams, but the messages are processed by the TCP/IP software and directly apparent to the application user.

DoS Thresholds

For DoS attacks, the AMG1312-T Series uses thresholds to determine when to drop sessions that do not become fully established. These thresholds apply globally to all sessions. You can use the default threshold values, or you can change them to values more suitable to your security requirements.

15.2 The Firewall General Screen

Use this screen to select the firewall protection level on the AMG1312-T Series. Click **Security > Firewall > General** to display the following screen.

Figure 85 Security > Firewall > General

Firewall

High
This setting blocks all traffic to and from the Internet. Only local network traffic and LAN to WAN service (Telnet, FTP, HTTP, HTTPS, DNS, POP3, SMTP) is permitted.

Medium
This is the recommended setting. It allows traffic to the Internet but blocks anyone from the Internet from accessing any services on your local network.

Low
This setting allows traffic to the Internet and also allows someone from the Internet to access services on your local network. This would be used with Port Forwarding, Default Server.

Custom
This setting allows the customer to create and edit individual firewall rules.

Off
This setting is not recommended. It disables firewall protection for your network and could potentially expose your network to significant security risks. This option should only be used for troubleshooting or if you intend using another firewall in conjunction with your ZyXEL router.

The following table describes the labels in this screen.

Table 64 Security > Firewall > General

LABEL	DESCRIPTION
High	This setting blocks all traffic to and from the Internet. Only local network traffic and LAN to WAN service (Telnet, FTP, HTTP, HTTPS, DNS, POP3, SMTP) is permitted.
Medium	This is the recommended setting. It allows traffic to the Internet but blocks anyone from the Internet from accessing any services on your local network.
Low	This setting allows traffic to the Internet and also allows someone from the Internet to access services on your local network. This would be used with Port Forwarding, Default Server.
Custom	This setting allows the customer to create and edit individual firewall rules. Firewall rules can be created in the Default Action screen (Section 15.3 on page 171) and Rules screen (Section 15.4 on page 173).
Off	This setting is not recommended. It disables firewall protection for your network and could potentially expose your network to significant security risks. This option should only be used for troubleshooting or if you intend using another firewall in conjunction with your ZyXEL router.
Apply	Click this to save your changes.
Cancel	Click this to restore your previously saved settings.

15.3 The Default Action Screen

Use this screen to set the default action that the firewall takes on packets that do not match any of the firewall rules. Click **Security > Firewall > Default Action** to display the following screen.

Figure 86 Security > Firewall > Default Action

Packet Direction	Default Action
WAN to LAN	Drop
LAN to WAN	Permit
WAN to Router	Drop
LAN to Router	Permit

The following table describes the labels in this screen.

Table 65 Security > Firewall > Default Action

LABEL	DESCRIPTION
Packet Direction	<p>This is the direction of travel of packets (LAN to Router, LAN to WAN, WAN to Router, WAN to LAN).</p> <p>Firewall rules are grouped based on the direction of travel of packets to which they apply. For example, LAN to Router means packets traveling from a computer/subnet on the LAN to the AMG1312-T Series itself.</p>
Default Action	<p>Use the drop-down list boxes to select the default action that the firewall is to take on packets that are traveling in the selected direction and do not match any of the firewall rules.</p> <p>Select Drop to silently discard the packets without sending a TCP reset packet or an ICMP destination-unreachable message to the sender.</p> <p>Select Reject to deny the packets and send a TCP reset packet (for a TCP packet) or an ICMP destination-unreachable message (for a UDP packet) to the sender.</p> <p>Select Permit to allow the passage of the packets.</p>
Apply	Click this to save your changes.
Cancel	Click this to restore your previously saved settings.

15.4 The Rules Screen

Click **Security > Firewall > Rules** to display the following screen. This screen displays a list of the configured firewall rules. Note the order in which the rules are listed.

Note: The firewall configuration screen shown in this section is specific to the following devices: P-The ordering of your rules is very important as rules are applied in turn.

Figure 87 Security > Firewall > Rules

The following table describes the labels in this screen.

Table 66 Security > Firewall > Rules

LABEL	DESCRIPTION
Firewall Rules Storage Space in Use	This read-only bar shows how much of the AMG1312-T Series's memory for recording firewall rules it is currently using. When you are using 80% or less of the storage space, the bar is green. When the amount of space used is over 80%, the bar is red.
Packet Direction	Use the drop-down list box to select a direction of travel of packets for which you want to configure firewall rules.
Create a new rule after rule number	Select an index number and click Add to add a new firewall rule after the selected index number. For example, if you select "6", your new rule becomes number 7 and the previous rule 7 (if there is one) becomes rule 8.
	The following read-only fields summarize the rules you have created that apply to traffic traveling in the selected packet direction. The firewall rules that you configure (summarized below) take priority over the general firewall action settings in the General screen.
#	This is your firewall rule number. The ordering of your rules is important as rules are applied in turn.
Active	This field displays whether a firewall is turned on or not. Select the check box to enable the rule. Clear the check box to disable the rule.
Source IP Address	This column displays the source addresses or ranges of addresses to which this firewall rule applies. Please note that a blank source or destination address is equivalent to Any .
Destination IP Address	This column displays the destination addresses or ranges of addresses to which this firewall rule applies. Please note that a blank source or destination address is equivalent to Any .
Service	This column displays the services to which this firewall rule applies. See Appendix F on page 286 for more information.
Action	This field displays whether the firewall silently discards packets (Drop), discards packets and sends a TCP reset packet or an ICMP destination-unreachable message to the sender (Reject) or allows the passage of packets (Permit).
Source Interface	This column displays the source interface to which this firewall rule applies. This is the interface through which the traffic entered the AMG1312-T Series. Please note that a blank source interface is equivalent to Any .

Table 66 Security > Firewall > Rules (continued)

LABEL	DESCRIPTION
Destination Interface	This column displays the destination interface to which this firewall rule applies. This is the interface through which the traffic is destined to leave the AMG1312-T Series. Please note that a blank source interface is equivalent to Any .
Modify	Click the Edit icon to go to the screen where you can edit the rule. Click the Remove icon to delete an existing firewall rule. A window displays asking you to confirm that you want to delete the firewall rule. Note that subsequent firewall rules move up by one when you take this action.
Apply	Click this to save your changes.
Cancel	Click this to restore your previously saved settings.

15.4.1 The Rules Add Screen

Use this screen to configure firewall rules. In the **Rules** screen, select an index number and click **Add** or click a rule's **Edit** icon to display this screen and refer to the following table for information on the labels.

Figure 88 Security > Firewall > Rules > Add

The following table describes the labels in this screen.

Table 67 Security > Firewall > Rules > Add

LABEL	DESCRIPTION
Active	Select this option to enable this firewall rule.
Action for Matched Packets	Use the drop-down list box to select whether to discard (Drop), deny and send an ICMP destination-unreachable message to the sender of (Reject) or allow the passage of (Permit) packets that match this rule.
IP Version Type	Select the IP version, IPv4 or IPv6 , to apply this firewall rule to.
Rate Limit	Set a maximum number of packets per second, minute, or hour to limit the throughput of traffic that matches this rule.
Maximum Burst Number	Set the maximum number of packets that can be sent at the peak rate.
Log	This field determines if a log for packets that match the rule is created or not.
Rules/Destination Address	

Table 67 Security > Firewall > Rules > Add (continued)

LABEL	DESCRIPTION
Address Type	Do you want your rule to apply to packets with a particular (single) IP, a range of IP addresses (for instance, 192.168.1.10 to 192.169.1.50), a subnet or any IP address? Select an option from the drop-down list box that includes: Single Address, Range Address, Subnet Address and Any Address .
Start IP Address	Enter the single IP address or the starting IP address in a range here.
End IP Address	Enter the ending IP address in a range here.
Subnet Mask	Enter the subnet mask here, if applicable.
Source Mac Address	Specify a source MAC address of traffic to which to apply this firewall rule applies. Please note that a blank source MAC address is equivalent to any.
Source Interface	Specify a source interface to which this firewall rule applies. This is the interface through which the traffic entered the AMG1312-T Series. Please note that a blank source interface is equivalent to any.
Destination Interface	Specify a destination interface to which this firewall rule applies. This is the interface through which the traffic is destined to leave the AMG1312-T Series. Please note that a blank source interface is equivalent to any.
Services	
Available Services	Please see Appendix F on page 286 for more information on services available. Select a service from the Available Services box.
Edit Customized Service	Click the Edit Customized Service button to bring up the screen that you use to configure a new custom service that is not in the predefined list of services.
TCP Flag	Specify any TCP flag bits the firewall rule is to check for.
Schedule	Select the days and time during which to apply the rule. Select Everyday and All Day to always apply the rule.
Apply	Click this to save your changes.
Cancel	Click this to restore your previously saved settings.

15.4.2 Customized Services

Configure customized services and port numbers not predefined by the AMG1312-T Series. For a comprehensive list of port numbers and services, visit the IANA (Internet Assigned Number Authority) website. See [Appendix F on page 286](#) for some examples. Click the **Edit Customized Services** button while editing a firewall rule to configure a custom service port. This displays the following screen.

Figure 89 Security > Firewall > Rules: Edit: Edit Customized Services

#	Name	Protocol	Port Type	Start Port	End Port	Modify

Add OK

The following table describes the labels in this screen.

Table 68 Security > Firewall > Rules: Edit: Edit Customized Services

LABEL	DESCRIPTION
#	This is the number of your customized port.
Name	This is the name of your customized service.
Protocol	This shows the IP protocol (TCP or UDP) that defines your customized service.
Port Type	This is the port number or range that defines your customized service.
Start Port	This is a single port number or the starting port number of a range that defines your customized service.
End Port	This is a single port number or the ending port number of a range that defines your customized service.
Modify	Click this to edit a customized service.
Add	Click this to configure a customized service.
Back	Click this to return to the Firewall Edit Rule screen.

15.4.3 Customized Service Add/Edit

Use this screen to add a customized rule or edit an existing rule. Click **Add** or the **Edit** icon next to a rule number in the **Firewall Customized Services** screen to display the following screen.

Figure 90 Security > Firewall > Rules: Edit: Edit Customized Services: Add/Edit

Config

Service Name

Service Type ▾

Port Configuration

Type Single Port Range

Port Number From To

Apply Cancel

The following table describes the labels in this screen.

Table 69 Security > Firewall > Rules: Edit: Edit Customized Services: Add/Edit

LABEL	DESCRIPTION
Config	
Service Name	Type a unique name for your custom port.
Service Type	Choose the IP port (TCP or UDP) that defines your customized port from the drop down list box.
Port Configuration	
Type	Click Single to specify one port only or Port Range to specify a span of ports that define your customized service.
Port Number	Type a single port number or the range of port numbers that define your customized service.
Back	Click this to return to the previous screen without saving.
Apply	Click this to save your changes.
Cancel	Click this to restore your previously saved settings.
Delete	Click this to delete the current rule.

15.5 The DoS Screen

Use this screen to enable DoS protection. Click **Security > Firewall > Dos** to display the following screen.

Figure 91 Security > Firewall > Dos



The following table describes the labels in this screen.

Table 70 Security > Firewall > Dos

LABEL	DESCRIPTION
Denial of Services	Enable this to protect against DoS attacks. The AMG1312-T Series will drop sessions that surpass maximum thresholds.
Apply	Click this to save your changes.
Cancel	Click this to restore your previously saved settings.
Advanced	Click this to go to a screen to specify maximum thresholds at which the AMG1312-T Series will start dropping sessions.

15.5.1 The DoS Advanced Screen

For DoS attacks, the AMG1312-T Series uses thresholds to determine when to start dropping sessions that do not become fully established (half-open sessions). These thresholds apply globally to all sessions.

For TCP, half-open means that the session has not reached the established state—the TCP three-way handshake has not yet been completed. Under normal circumstances, the application that initiates a session sends a SYN (synchronize) packet to the receiving server. The receiver sends back an ACK (acknowledgment) packet and its own SYN, and then the initiator responds with an ACK (acknowledgment). After this handshake, a connection is established.

Figure 92 Three-Way Handshake

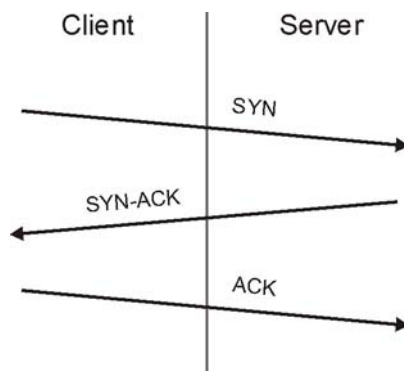

For UDP, half-open means that the firewall has detected no return traffic. An unusually high number (or arrival rate) of half-open sessions could indicate a DOS attack.

15.5.1.1 Threshold Values

If everything is working properly, you probably do not need to change the threshold settings as the default threshold values should work for most small offices. Tune these parameters when you believe the AMG1312-T Series has been receiving DoS attacks that are not recorded in the logs or the logs show that the AMG1312-T Series is classifying normal traffic as DoS attacks. Factors influencing choices for threshold values are:

- 1 The maximum number of opened sessions.
- 2 The minimum capacity of server backlog in your LAN network.
- 3 The CPU power of servers in your LAN network.
- 4 Network bandwidth.
- 5 Type of traffic for certain servers.

Reduce the threshold values if your network is slower than average for any of these factors (especially if you have servers that are slow or handle many tasks and are often busy).

- If you often use P2P applications such as file sharing with eMule or eDonkey, it's recommended that you increase the threshold values since lots of sessions will be established during a small period of time and the AMG1312-T Series may classify them as DoS attacks.

15.5.2 Configuring Firewall Thresholds

Click **Security > Firewall > DoS > Advanced** to display the following screen.

Figure 93 Security > Firewall > DoS > Advanced

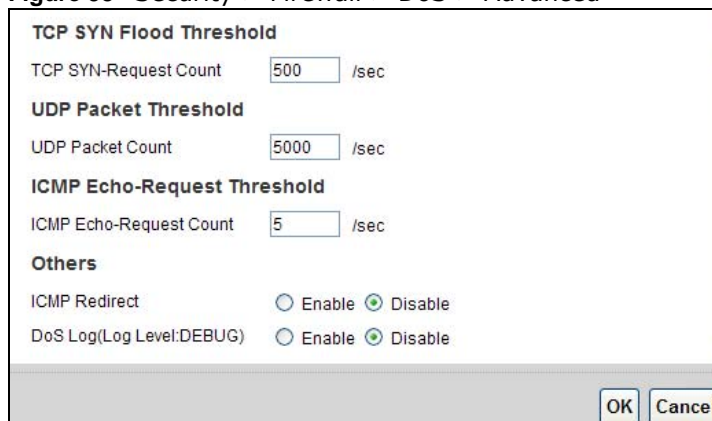

TCP SYN Flood Threshold
TCP SYN-Request Count /sec

UDP Packet Threshold
UDP Packet Count /sec

ICMP Echo-Request Threshold
ICMP Echo-Request Count /sec

Others

ICMP Redirect Enable Disable

DoS Log(Log Level:DEBUG) Enable Disable

OK Cancel

The following table describes the labels in this screen.

Table 71 Security > Firewall > DoS > Advanced

LABEL	DESCRIPTION
TCP SYN-Request Count	This is the rate of new TCP half-open sessions per second that causes the firewall to start deleting half-open sessions. When the rate of new connection attempts rises above this number, the AMG1312-T Series deletes half-open sessions as required to accommodate new connection attempts.
UDP Packet Count	This is the rate of new UDP half-open sessions per second that causes the firewall to start deleting half-open sessions. When the rate of new connection attempts rises above this number, the AMG1312-T Series deletes half-open sessions as required to accommodate new connection attempts.
ICMP Echo-Request Count	This is the rate of new ICMP Echo-Request half-open sessions per second that causes the firewall to start deleting half-open sessions. When the rate of new connection attempts rises above this number, the AMG1312-T Series deletes half-open sessions as required to accommodate new connection attempts.
Back	Click this button to return to the previous screen.
Apply	Click this to save your changes.
Cancel	Click this to restore your previously saved settings.

15.6 Firewall Technical Reference

This section provides some technical background information about the topics covered in this chapter.

15.6.1 Firewall Rules Overview

Your customized rules take precedence and override the AMG1312-T Series's default settings. The AMG1312-T Series checks the source IP address, destination IP address and IP protocol type of network traffic against the firewall rules (in the order you list them). When the traffic matches a rule, the AMG1312-T Series takes the action specified in the rule.

Firewall rules are grouped based on the direction of travel of packets to which they apply:

- LAN to Router
- LAN to WAN
- WAN to LAN
- WAN to Router

Note: The LAN includes both the LAN port and the WLAN.

By default, the AMG1312-T Series's stateful packet inspection allows packets traveling in the following directions:

- LAN to Router
 - These rules specify which computers on the LAN can manage the AMG1312-T Series (remote management).

Note: You can also configure the remote management settings to allow only a specific computer to manage the AMG1312-T Series.

- LAN to WAN

These rules specify which computers on the LAN can access which computers or services on the WAN.

By default, the AMG1312-T Series's stateful packet inspection drops packets traveling in the following directions:

- WAN to LAN

These rules specify which computers on the WAN can access which computers or services on the LAN.

Note: You also need to configure NAT port forwarding (or full featured NAT address mapping rules) to allow computers on the WAN to access devices on the LAN.

- WAN to Router

By default the AMG1312-T Series stops computers on the WAN from managing the AMG1312-T Series. You could configure one of these rules to allow a WAN computer to manage the AMG1312-T Series.

Note: You also need to configure the remote management settings to allow a WAN computer to manage the AMG1312-T Series.

You may define additional rules and sets or modify existing ones but please exercise extreme caution in doing so.

For example, you may create rules to:

- Block certain types of traffic, such as IRC (Internet Relay Chat), from the LAN to the Internet.
- Allow certain types of traffic, such as Lotus Notes database synchronization, from specific hosts on the Internet to specific hosts on the LAN.
- Allow everyone except your competitors to access a web server.
- Restrict use of certain protocols, such as Telnet, to authorized users on the LAN.

These custom rules work by comparing the source IP address, destination IP address and IP protocol type of network traffic to rules set by the administrator. Your customized rules take precedence and override the AMG1312-T Series's default rules.

15.6.2 Guidelines For Enhancing Security With Your Firewall

- 6 Change the default password via web configurator.
- 7 Think about access control before you connect to the network in any way.
- 8 Limit who can access your router.
- 9 Don't enable any local service (such as telnet or FTP) that you don't use. Any enabled service could present a potential security risk. A determined hacker might be able to find creative ways to misuse the enabled services to access the firewall or the network.
- 10 For local services that are enabled, protect against misuse. Protect by configuring the services to communicate only with specific peers, and protect by configuring rules to block packets for the services at specific interfaces.

- 11 Protect against IP spoofing by making sure the firewall is active.
- 12 Keep the firewall in a secured (locked) room.

15.6.3 Security Considerations

Note: Incorrectly configuring the firewall may block valid access or introduce security risks to the AMG1312-T Series and your protected network. Use caution when creating or deleting firewall rules and test your rules after you configure them.

Consider these security ramifications before creating a rule:

- 1 Does this rule stop LAN users from accessing critical resources on the Internet? For example, if IRC is blocked, are there users that require this service?
- 2 Is it possible to modify the rule to be more specific? For example, if IRC is blocked for all users, will a rule that blocks just certain users be more effective?
- 3 Does a rule that allows Internet users access to resources on the LAN create a security vulnerability? For example, if FTP ports (TCP 20, 21) are allowed from the Internet to the LAN, Internet users may be able to connect to computers with running FTP servers.
- 4 Does this rule conflict with any existing rules?

Once these questions have been answered, adding rules is simply a matter of entering the information into the correct fields in the web configurator screens.

15.6.4 Triangle Route

When the firewall is on, your AMG1312-T Series acts as a secure gateway between your LAN and the Internet. In an ideal network topology, all incoming and outgoing network traffic passes through the AMG1312-T Series to protect your LAN against attacks.

Figure 94 Ideal Firewall Setup

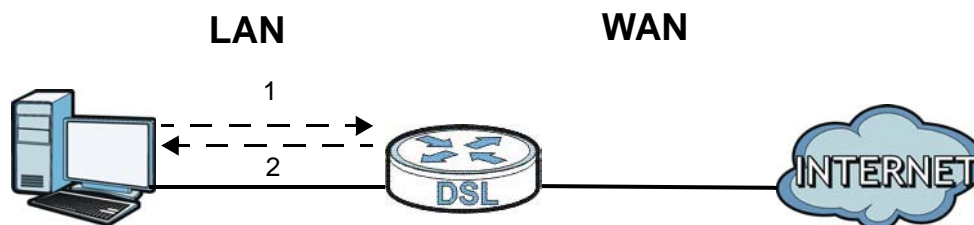

15.6.4.1 The “Triangle Route” Problem

A traffic route is a path for sending or receiving data packets between two Ethernet devices. You may have more than one connection to the Internet (through one or more ISPs). If an alternate gateway is on the LAN (and its IP address is in the same subnet as the AMG1312-T Series’s LAN IP address), the “triangle route” (also called asymmetrical route) problem may occur. The steps below describe the “triangle route” problem.

- 1 A computer on the LAN initiates a connection by sending out a SYN packet to a receiving server on the WAN.
- 2 The AMG1312-T Series reroutes the SYN packet through Gateway **A** on the LAN to the WAN.
- 3 The reply from the WAN goes directly to the computer on the LAN without going through the AMG1312-T Series.

As a result, the AMG1312-T Series resets the connection, as the connection has not been acknowledged.

Figure 95 "Triangle Route" Problem

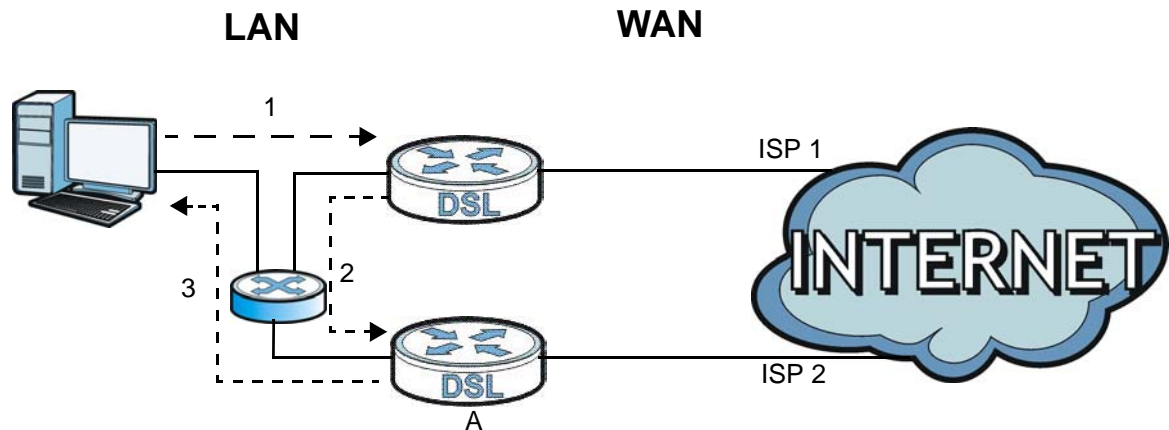

15.6.4.2 Solving the "Triangle Route" Problem

If you have the AMG1312-T Series allow triangle route sessions, traffic from the WAN can go directly to a LAN computer without passing through the AMG1312-T Series and its firewall protection.

Another solution is to use IP alias. IP alias allows you to partition your network into logical sections over the same Ethernet interface. Your AMG1312-T Series supports up to three logical LAN interfaces with the AMG1312-T Series being the gateway for each logical network.

It's like having multiple LAN networks that actually use the same physical cables and ports. By putting your LAN and Gateway **A** in different subnets, all returning network traffic must pass through the AMG1312-T Series to your LAN. The following steps describe such a scenario.

- 1 A computer on the LAN initiates a connection by sending a SYN packet to a receiving server on the WAN.
- 2 The AMG1312-T Series reroutes the packet to Gateway **A**, which is in Subnet 2.
- 3 The reply from the WAN goes to the AMG1312-T Series.
- 4 The AMG1312-T Series then sends it to the computer on the LAN in Subnet 1.

Figure 96 IP Alias

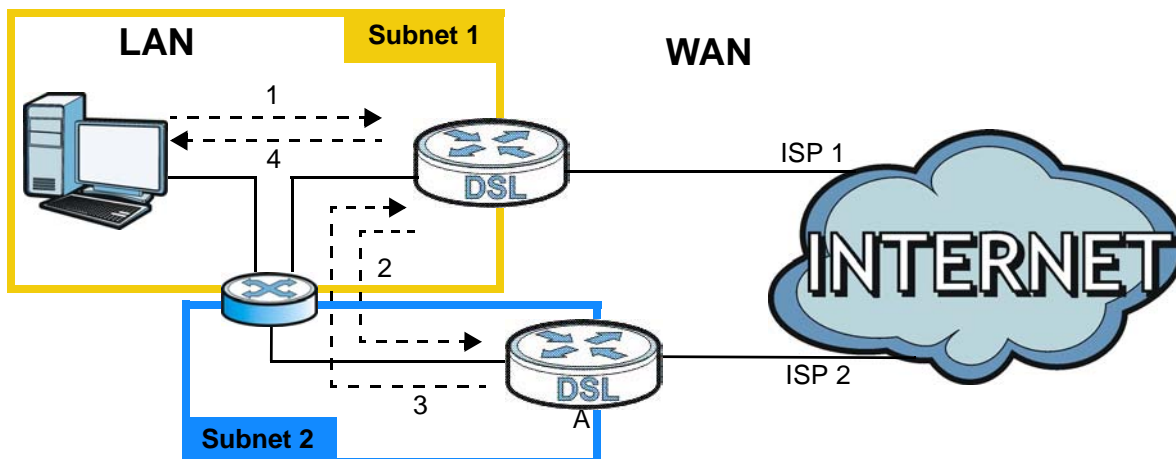

Parental Control

16.1 Overview

Parental control allows you to block web sites with the specific URL. You can also define time periods and days during which the AMG1312-T Series performs parental control on a specific user.

16.2 The Parental Control Screen

Use this screen to enable parental control, view the parental control rules and schedules.

Click **Security > Parental Control** to open the following screen.

Figure 97 Security > Parental Control

The screenshot shows the 'Parental Control' configuration screen. Under the 'General' tab, the 'Parental Control' option is set to 'Disable (settings are invalid when disabled)'. There is an 'Add new PCP' button. Below this is a table with the following columns: #, Status, PCP Name, Home Network User, Internet Access Schedule, Network Service, Website Blocked, and Modify. At the bottom right, there are 'Apply' and 'Cancel' buttons.

The following table describes the fields in this screen.

Table 72 Security > Parental Control

LABEL	DESCRIPTION
Parental Control	Use this field to activate or deactivate parental control.
Add new PCP	Click this to create a new parental control rule.
#	This is the index number of the rule.
Status	This indicates whether the rule is active or not. A yellow bulb signifies that this rule is active. A gray bulb signifies that this rule is not active.
PCP Name	This shows the name of the rule.
Home Network User	This shows the MAC address of the LAN user's computer to which this rule applies.
Internet Access Schedule	This shows the day(s) and time on which parental control is enabled.
Network Service	This shows whether the network service is configured. If not, None will be shown.

Table 72 Security > Parental Control (continued)

LABEL	DESCRIPTION
Website Blocked	This shows whether the website block is configured. If not, None will be shown.
Modify	Click the Edit icon to go to the screen where you can edit the rule. Click the Delete icon to delete an existing rule.
Apply	Click Apply to save your changes.
Cancel	Click Cancel to restore your previously saved settings.

16.2.1 Add/Edit Parental Control Rule

Click **Add new PCP** in the **Parental Control** screen to add a new rule or click the **Edit** icon next to an existing rule to edit it. Use this screen to configure a restricted access schedule and/or URL filtering settings to block the users on your network from accessing certain web sites.

Figure 98 Add/Edit Parental Control Rule

The following table describes the fields in this screen.

Table 73 Parental Control: Add/Edit

LABEL	DESCRIPTION
General	
Active	Select the checkbox to activate this parental control rule.

Table 73 Parental Control: Add/Edit (continued)

LABEL	DESCRIPTION
Parental Control Profile Name	Enter a descriptive name for the rule.
Home Network User	Select the LAN user that you want to apply this rule to from the drop-down list box. If you select Custom , enter the LAN user's MAC address. If you select All , the rule applies to all LAN users.
Internet Access Schedule	
Day	Select check boxes for the days that you want the AMG1312-T Series to perform parental control.
Time of Day to Apply	Enter the starting and ending time that the LAN user is allowed access.
Network Service	
Network Service Setting	If you select Block , the AMG1312-T Series prohibits the users from viewing the Web sites with the URLs listed below. If you select Access , the AMG1312-T Series blocks access to all URLs except ones listed below.
Add new service	Click this to show a screen in which you can add a new service rule. You can configure the Service Name , Protocol , and Name of the new rule.
Active	This shows whether a configured service is activated or not.
Service Name	This shows the name of the rule.
Protocol	This shows the protocol of the rule.
Port	This shows the port of the rule.
Modify	Click the Edit icon to go to the screen where you can edit the rule. Click the Delete icon to delete an existing rule.
Blocked Site/URL	Enter the URL of web sites or URL keywords to which the AMG1312-T Series blocks access.
Apply	Click Apply to save your changes.
Cancel	Click Cancel to exit this screen without saving.

Certificate

17.1 Overview

The AMG1312-T Series can use certificates (also called digital IDs) to authenticate users. Certificates are based on public-private key pairs. A certificate contains the certificate owner's identity and public key. Certificates provide a way to exchange public keys for use in authentication.

17.1.1 What You Can Do in this Chapter

- Use the **Local Certificates** screen to view and import the AMG1312-T Series's CA-signed certificates ([Section 17.3 on page 189](#)).
- The **Trusted CA** screen lets you save the certificates of trusted CAs to the AMG1312-T Series ([Section 17.4 on page 191](#)).

17.2 What You Need to Know

The following terms and concepts may help as you read through this chapter.

Certification Authority

A Certification Authority (CA) issues certificates and guarantees the identity of each certificate owner. There are commercial certification authorities like CyberTrust or VeriSign and government certification authorities. The certification authority uses its private key to sign certificates. Anyone can then use the certification authority's public key to verify the certificates. You can use the AMG1312-T Series to generate certification requests that contain identifying information and public keys and then send the certification requests to a certification authority.

Certificate File Format

The certification authority certificate that you want to import has to be in one of these file formats:

- PEM (Base-64) encoded X.509: This Privacy Enhanced Mail format uses 64 ASCII characters to convert a binary X.509 certificate into a printable form.

17.3 Local Certificates

Use this screen to view the AMG1312-T Series's summary list of certificates and certification requests. You can import the following certificates to your AMG1312-T Series:

- Web Server - This certificate secures HTTP connections.
- SSH - This certificate secures remote connections.

Click **Security > Certificates** to open the **Local Certificates** screen.

Figure 99 Security > Certificates > Local Certificates

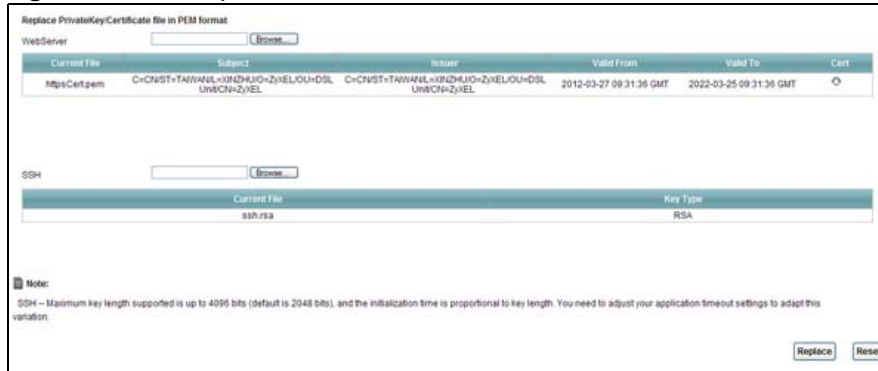

The following table describes the labels in this screen.

Table 74 Security > Certificates > Local Certificates

LABEL	DESCRIPTION
WebServer	Click Browse... to find the certificate file you want to upload.
Current File	This field displays the name used to identify this certificate. It is recommended that you give each certificate a unique name.
Subject	This field displays identifying information about the certificate's owner, such as CN (Common Name), OU (Organizational Unit or department), O (Organization or company) and C (Country). It is recommended that each certificate have unique subject information.
Issuer	This field displays identifying information about the certificate's issuing certification authority, such as a common name, organizational unit or department, organization or company and country.
Valid From	This field displays the date that the certificate becomes applicable. The text displays in red and includes a Not Yet Valid! message if the certificate has not yet become applicable.
Valid To	This field displays the date that the certificate expires. The text displays in red and includes an Expiring! or Expired! message if the certificate is about to expire or has already expired.
Cert	Click this button and then Save in the File Download screen. The Save As screen opens, browse to the location that you want to use and click Save .
SSH	Type in the location of the SSH certificate file you want to upload in this field or click Browse to find it.
Current File	This field displays the name used to identify this certificate. It is recommended that you give each certificate a unique name.
Key Type	This field applies to the SSH certificate. This shows the file format of the current certificate.
Replace	Click this to replace the certificate(s) and save your changes back to the AMG1312-T Series.
Reset	Click this to clear your settings.

17.4 The Trusted CA Screen

Use this screen to view a summary list of certificates of the certification authorities that you have set the AMG1312-T Series to accept as trusted. The AMG1312-T Series accepts any valid certificate signed by a certification authority on this list as being trustworthy; thus you do not need to import any certificate that is signed by one of these certification authorities.

Click **Security > Certificates > Trusted CA** to open the **Trusted CA** screen.

Figure 100 Security > Certificates > Trusted CA

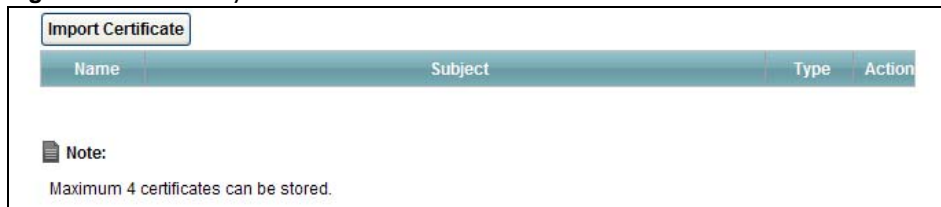

The following table describes the fields in this screen.

Table 75 Security > Certificates > Trusted CA

LABEL	DESCRIPTION
Import Certificate	Click this button to open a screen where you can save the certificate of a certification authority that you trust to the AMG1312-T Series.
Name	This field displays the name used to identify this certificate.
Subject	This field displays information that identifies the owner of the certificate, such as Common Name (CN), OU (Organizational Unit or department), Organization (O), State (ST) and Country (C). It is recommended that each certificate have unique subject information.
Type	This field displays general information about the certificate. ca means that a Certification Authority signed the certificate.
Action	Click View to open a screen with an in-depth list of information about the certificate. Click Remove to delete the certificate.

17.5 Trusted CA Import

Click **Import Certificate** in the **Trusted CA** screen to open the **Import Certificate** screen. You can save a trusted certification authority's certificate to the AMG1312-T Series.

Note: You must remove any spaces from the certificate's filename before you can import the certificate.

Figure 101 Trusted CA > Import

The certificate is in one of the following formats.

- Binary X.509
- PEM (Base-64) encoded
- Binary PKCS#7
- PEM (Base-64) encoded PKCS#7

Certificate File Path ::

The following table describes the labels in this screen.

Table 76 Security > Certificates > Trusted CA > Import

LABEL	DESCRIPTION
Certificate File Path	Type in the location of the file you want to upload in this field or click Browse to find it.
Browse	Click Browse to find the certificate file you want to upload.
Apply	Click Apply to save the certificate on the AMG1312-T Series.
Back	Click Back to return to the previous screen.

17.6 View Certificate

Use this screen to view in-depth information about the certification authority's certificate, change the certificate's name and set whether or not you want the AMG1312-T Series to check a certification authority's list of revoked certificates before trusting a certificate issued by the certification authority.

Click **Security > Certificates > Trusted CA** to open the **Trusted CA** screen. Click the **View** icon to open the **View Certificate** screen.

Figure 102 Trusted CA: View

Certificate Details	
Name	cert
Type	request
Subject	CN=ZyXEL/O=TW/ST=NA/C=US
Certificate	{null}

The following table describes the labels in this screen.

Table 77 Trusted CA: View

LABEL	DESCRIPTION
Certificate Name	This field displays the identifying name of this certificate. If you want to change the name, type up to 31 characters to identify this key certificate. You may use any character (not including spaces).
Certificate Detail	This read-only text box displays the certificate or certification request in Privacy Enhanced Mail (PEM) format. PEM uses 64 ASCII characters to convert the binary certificate into a printable form. You can copy and paste the certificate into an e-mail to send to friends or colleagues or you can copy and paste the certificate into a text editor and save the file on a management computer for later distribution (via floppy disk for example).
Back	Click this to return to the previous screen.

18.1 Overview

The web configurator allows you to choose which categories of events and/or alerts to have the AMG1312-T Series log and then display the logs or have the AMG1312-T Series send them to an administrator (as e-mail) or to a syslog server.

18.1.1 What You Can Do in this Chapter

- Use the **Log** screen to see the system logs for the categories that you select ([Section 18.2 on page 195](#)).

18.1.2 What You Need To Know

The following terms and concepts may help as you read this chapter.

Alerts and Logs

An alert is a type of log that warrants more serious attention. They include system errors, attacks (access control) and attempted access to blocked web sites. Some categories such as **System Errors** consist of both logs and alerts. You may differentiate them by their color in the **View Log** screen. Alerts display in red and logs display in black.

Syslog Overview

The syslog protocol allows devices to send event notification messages across an IP network to syslog servers that collect the event messages. A syslog-enabled device can generate a syslog message and send it to a syslog server.

Syslog is defined in RFC 3164. The RFC defines the packet format, content and system log related information of syslog messages. Each syslog message has a facility and severity level. The syslog facility identifies a file in the syslog server. Refer to the documentation of your syslog program for details. The following table describes the syslog severity levels.

Table 78 Syslog Severity Levels

CODE	SEVERITY
0	Emergency: The system is unusable.
1	Alert: Action must be taken immediately.
2	Critical: The system condition is critical.
3	Error: There is an error condition on the system.
4	Warning: There is a warning condition on the system.
5	Notice: There is a normal but significant condition on the system.

Table 78 Syslog Severity Levels (continued)

CODE	SEVERITY
6	Informational: The syslog contains an informational message.
7	Debug: The message is intended for debug-level purposes.

18.2 The System Log Screen

Click **System Monitor > Log** to open the **System Log** screen. Use the **System Log** screen to see the system logs for the categories that you select in the upper left drop-down list box.

Figure 103 System Monitor > Log > System Log

#	Time	Level	Message
1	Jan 1 00:10:17	INFO	Connecting PPPoE socket: 00:00:00:00:00:00 0000 0x48f088
2	Jan 1 00:10:17	ERROR	Couldn't get channel number: Transport endpoint is not connected
3	Jan 1 00:10:17	WARNING	Doing disconnect
4	Jan 1 00:11:17	INFO	Sending PADI
5	Jan 1 00:21:17	INFO	Connecting PPPoE socket: 00:00:00:00:00:00 0000 0x48f088
6	Jan 1 00:21:17	ERROR	Couldn't get channel number: Transport endpoint is not connected
7	Jan 1 00:21:17	WARNING	Doing disconnect
8	Jan 1 00:22:17	INFO	Sending PADI

The following table describes the fields in this screen.

Table 79 System Monitor > Log > System Log

LABEL	DESCRIPTION
Level	Select a severity level from the drop-down list box. This filters search results according to the severity level you have selected. When you select a severity, the AMG1312-T Series searches through all logs of that severity or higher.
Refresh	Click this to renew the log screen.
Clear Logs	Click this to delete all the logs.
Export	Click this to download logs to a file on your computer.
Email Log Now	Click this to send logs to a specified e-mail address.
#	This field is a sequential value and is not associated with a specific entry.
Time	This field displays the time the log was recorded.
Level	This field displays the severity level of the logs that the device is to send to this syslog server.
Message	This field states the reason for the log.

Traffic Status

19.1 Overview

Use the **Traffic Status** screens to look at network traffic status and statistics of the WAN, LAN interfaces and NAT.

19.1.1 What You Can Do in this Chapter

- Use the **WAN** screen to view the WAN traffic statistics ([Section 19.2 on page 196](#)).
- Use the **LAN** screen to view the LAN traffic statistics ([Section 19.3 on page 197](#)).
- Use the **NAT** screen to view the NAT status of the AMG1312-T Series's client(s) ([Section 19.4 on page 198](#)).

19.2 The WAN Status Screen

Click **System Monitor > Traffic Status** to open the **WAN** screen. You can view the WAN traffic statistics in this screen.

Figure 104 System Monitor > Traffic Status > WAN

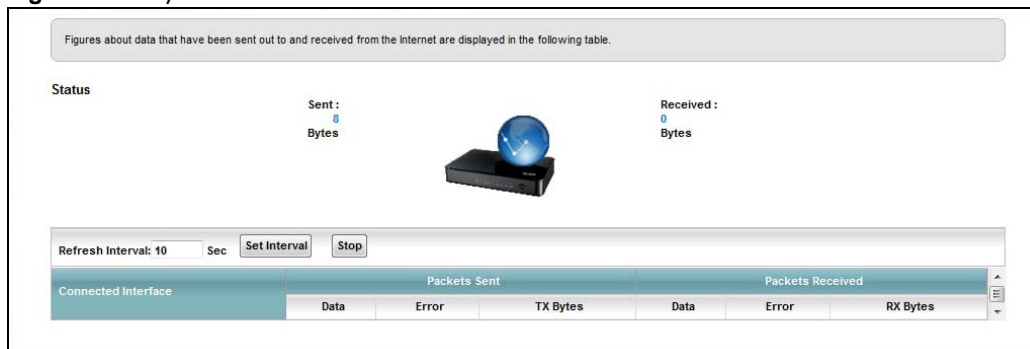

The following table describes the fields in this screen.

Table 80 System Monitor > Traffic Status > WAN

LABEL	DESCRIPTION
Status	This shows the number of bytes received and sent through the WAN interface of the AMG1312-T Series.
Refresh Interval	Select how often you want the AMG1312-T Series to update this screen from the drop-down list box.
Connected Interface	This shows the name of the WAN interface that is currently connected.

Table 80 System Monitor > Traffic Status > WAN (continued)

LABEL	DESCRIPTION
Packets Sent	
Data	This indicates the number of transmitted packets on this interface.
Error	This indicates the number of frames with errors transmitted on this interface.
Drop	This indicates the number of outgoing packets dropped on this interface.
Packets Received	
Data	This indicates the number of received packets on this interface.
Error	This indicates the number of frames with errors received on this interface.
Drop	This indicates the number of received packets dropped on this interface.

19.3 The LAN Status Screen

Click **System Monitor > Traffic Status > LAN** to open the following screen. You can view the LAN traffic statistics in this screen.

Figure 105 System Monitor > Traffic Status > LAN

The screenshot shows the LAN Status screen with the following elements:

- Refresh Interval: 10 Sec (with Set Interval and Stop buttons)
- Table 1: Bytes Sent and Bytes Received for LAN1, LAN2, LAN3, LAN4, and Wireless.
- Table 2: Packet statistics (Data, Error, Drop) for Sent and Received packets across LAN1, LAN2, LAN3, LAN4, and Wireless.

Interface	LAN1	LAN2	LAN3	LAN4	Wireless
Bytes Sent	19285011	19285011	19285011	51083049	0
Bytes Received	0	0	0	5470703	18266090

Interface	LAN1	LAN2	LAN3	LAN4	Wireless	
Sent (Packet)	Data	54633	54633	54633	89768	1686
	Error	0	0	0	0	0
	Drop	0	0	0	0	0
Received (Packet)	Data	0	0	0	41220	64888
	Error	0	0	0	0	0
	Drop	0	0	0	0	0

The following table describes the fields in this screen.

Table 81 System Monitor > Traffic Status > LAN

LABEL	DESCRIPTION
Refresh Interval(s)	Select how often you want the AMG1312-T Series to update this screen from the drop-down list box.
Set Interval	Click this button to apply the new poll interval you entered in the Refresh Interval field.
Stop	Click Stop to stop refreshing statistics.
Interface	This shows the LAN or WLAN interface.
Bytes Sent	This indicates the number of bytes transmitted on this interface.
Bytes Received	This indicates the number of bytes received on this interface.
Interface	This shows the LAN or WLAN interface.
Sent (Packet)	

Table 81 System Monitor > Traffic Status > LAN (continued)

LABEL	DESCRIPTION
Data	This indicates the number of transmitted packets on this interface.
Error	This indicates the number of frames with errors transmitted on this interface.
Drop	This indicates the number of outgoing packets dropped on this interface.
Received (Packet)	
Data	This indicates the number of received packets on this interface.
Error	This indicates the number of frames with errors received on this interface.
Drop	This indicates the number of received packets dropped on this interface.

19.4 The NAT Screen

Click **System Monitor > Traffic Status > NAT** to open the following screen. You can view the NAT status of the AMG1312-T Series's client(s) in this screen.

Figure 106 System Monitor > Traffic Status > NAT

Refresh Interval: 10 Sec	Set Interval	Stop	
Device Name	IP Address	MAC Address	No. of Open Session
Unknown	192.168.1.60	6C:F0:49:70:12:C5	103
			Total : 103

The following table describes the fields in this screen.

Table 82 System Monitor > Traffic Status > NAT

LABEL	DESCRIPTION
Refresh Interval	Select how often you want the AMG1312-T Series to update this screen from the drop-down list box.
Set Interval	Click this button to apply the new poll interval you entered in the Refresh Interval field.
Stop	Click Stop to stop refreshing statistics.
Device Name	This shows the name of the client.
IP Address	This shows the IP address of the client.
MAC Address	This shows the MAC address of the client.
No. of Open Session	This shows the number of NAT sessions used by the client.

User Account

20.1 Overview

You can configure system password for different user accounts in the **User Account** screen.

20.2 The User Account Screen

Use the **User Account** screen to configure system password.

Click **Maintenance > User Account** to open the following screen.

Figure 107 Maintenance > User Account

The screenshot shows a web form with the following elements:

- User Name:** A text input field containing the value "admin".
- Old Password:** An empty password input field.
- New Password:** An empty password input field.
- Retype to Confirm:** An empty password input field.
- Buttons:** Two buttons labeled "Apply" and "Cancel" are located at the bottom right of the form.

The following table describes the labels in this screen.

Table 83 Maintenance > User Account

LABEL	DESCRIPTION
User Name	You can configure the password for the Power User and Admin accounts.
Old Password	Type the default password or the existing password you use to access the system in this field.
New Password	Type your new system password (up to 30 characters). Note that as you type a password, the screen displays a (*) for each character you type. After you change the password, use the new password to access the AMG1312-T Series.
Retype to Confirm	Type the new password again for confirmation.
Apply	Click Apply to save your changes.
Cancel	Click Cancel to restore your previously saved settings.

TR-069 Client

21.1 Overview

The AMG1312-T Series supports TR-069 Amendment 1 (CPE WAN Management Protocol Release 2.0) and TR-069 Amendment 2 (CPE WAN Management Protocol v1.1, Release 3.0).

TR-069 is a protocol that defines how your AMG1312-T Series (**ZD**) can be managed via a management server (**MS**) such as ZyXEL's Vantage Access.

Figure 108 LAN and WAN

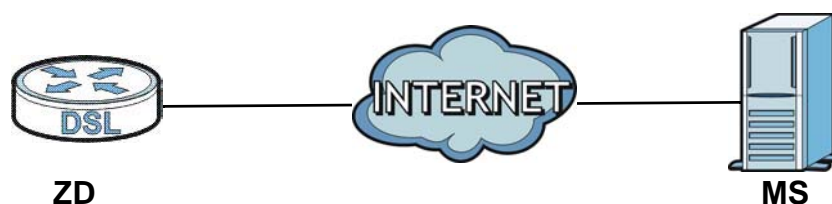

An administrator can use a management server to remotely set up the AMG1312-T Series, modify settings, perform firmware upgrades as well as monitor and diagnose the AMG1312-T Series.

In order to use CWMP, you need to configure the following steps:

- 1 Activate CWMP
- 2 Specify the URL, username and password.
- 3 Activate periodic inform and specify an interval value.

21.2 The TR-069 Client Screen

Use this screen to configure your AMG1312-T Series to be managed by a management server. Click **Maintenance > TR-069 Client** to display the following screen.

Figure 109 Maintenance > TR-069 Client

CWMP	<input type="radio"/> Enable <input checked="" type="radio"/> Disable
ACS URL:	<input type="text"/>
ACS User Name:	<input type="text" value="admin"/>
ACS Password:	<input type="text" value="admin"/>
Connection Request Path:	<input type="text" value="/tr69"/>
Connection Request Port:	<input type="text" value="7547"/>
Connection Request User Name:	<input type="text" value="admin"/>
Connection Request Password:	<input type="text" value="admin"/>
Inform	<input type="radio"/> Enable <input checked="" type="radio"/> Disable
Inform Interval:	<input type="text" value="300"/> Sec
<input type="button" value="Apply"/> <input type="button" value="Cancel"/>	

The following table describes the fields in this screen.

Table 84 Maintenance > TR-069 Client

LINK	DESCRIPTION
CWMP	Select Enable to allow the AMG1312-T Series to be managed by a management server or select Disable to not allow the AMG1312-T Series to be managed by a management server.
ACS URL	Type the IP address or domain name of the management server. If the AMG1312-T Series is behind a NAT router that assigns it a private IP address, you will have to configure a NAT port forwarding rule on the NAT router.
ACS User Name	The user name is used to authenticate the AMG1312-T Series when making a connection to the management server. This user name on the management server and the AMG1312-T Series must be the same. Type a user name of up to 255 printable characters found on an English-language keyboard. Spaces and characters such as @#\$%^&*()_+ are allowed.
ACS Password	The password is used to authenticate the AMG1312-T Series when making a connection to the management server. This password on the management server and the AMG1312-T Series must be the same. Type a password of up to 255 printable characters found on an English-language keyboard.
Connection Request Path	Type the IP address or domain name of the AMG1312-T Series. The management server uses this path to verify the AMG1312-T Series.
Connection Request Port	The default port for access to the AMG1312-T Series from the management server is port 7547. If you change it, make sure it does not conflict with another port on your network and it is recommended to use a port number above 1024 (not a commonly used port). The management server should use this port to connect to the AMG1312-T Series. You may need to alter your NAT port forwarding rules if they were already configured.
Connection Request UserName	The user name is used to authenticate the management server when connecting to the AMG1312-T Series. Type a user name of up to 255 printable characters found on an English-language keyboard. Spaces and characters such as @#\$%^&*()_+ are allowed.
Connection Request Password	The password is used to authenticate the management server when connecting to the AMG1312-T Series. Type a password of up to 255 printable characters found on an English-language keyboard. Spaces are not allowed.
Inform	Select Enable to have the AMG1312-T Series periodically send information to the management server (recommended if CWMP is enabled) or select Disable to not have the AMG1312-T Series periodically send information to the management server
Inform Interval	The interval is the duration in seconds for which the AMG1312-T Series must attempt to connect with the management server to send information and check for configuration updates. Enter a value between 1 and 86400 seconds.
Apply	Click this to save your changes.
Cancel	Click this to restore your previously saved settings.

System Settings

22.1 Overview

This chapter shows you how to configure system related settings, such as system time, password, name, the domain name and the inactivity timeout interval.

22.1.1 What You Can Do in the System Settings Screens

- Use the **System** screen ([Section 22.2 on page 202](#)) to configure system settings.
- Use the **Time Setting** screen ([Section 22.3 on page 202](#)) to set the system time.

22.2 The System Screen

Use this screen to configure system admin password.

Click **Maintenance > System** to open the screen as shown.

Figure 110 Maintenance > System

The screenshot shows a web interface for configuring system settings. It features a label 'Administrator Inactivity Timer' followed by a text input field containing the value '300'. To the right of the input field is the text '(seconds, 0 means no timeout)'. At the bottom right of the form are two buttons: 'Apply' and 'Cancel'.

The following table describes the labels in this screen.

Table 85 Maintenance > System

LABEL	DESCRIPTION
Administrator Inactivity Timer	Type how many seconds a management session (either via the web configurator) can be left idle before the session times out and you have to log in again. Very long idle timeouts may have security risks. A value of "0" means a management session never times out, no matter how long it has been left idle (not recommended).
Apply	Click this to save your changes.
Cancel	Click this to restore your previously saved settings.

22.3 The Time Screen

Use this screen to configure the AMG1312-T Series's time based on your local time zone. To change your AMG1312-T Series's time and date, click **Maintenance > System > Time Setting**. The screen appears as shown.

Figure 111 Maintenance > System > Time Setting

The following table describes the fields in this screen.

Table 86 Maintenance > System > Time

LABEL	DESCRIPTION
Current Date/Time	
Current Time	This field displays the time and date of your AMG1312-T Series. Each time you reload this page, the AMG1312-T Series synchronizes the time and date with the time server.
Time and Date Setup	
Manual	Select this radio button to enter the time and date manually. If you configure a new time and date, Time Zone and Daylight Saving at the same time, the new time and date you entered has priority and the Time Zone and Daylight Saving settings do not affect it.
Current Date/Time	This field displays the last updated time (in hh:mm:ss format) from the time server or the last time configured manually. When you set Time and Date Setup to Manual , enter the new time in this field and then click Apply .
Current Time	This field displays the last updated date (in yyyy/mm/dd format) from the time server or the last date configured manually. When you set Time and Date Setup to Manual , enter the new date in this field and then click Apply .
Get from Time Server	Select this radio button to have the AMG1312-T Series get the time and date from the time server you specified below.
Time Server Address 1/2	Enter the IP address or URL (up to 20 extended ASCII characters in length) of your time server. Check with your ISP/network administrator if you are unsure of this information.
Time Zone Setup	
Time Zone	Choose the time zone of your location. This will set the time difference between your time zone and Greenwich Mean Time (GMT).

Table 86 Maintenance > System > Time (continued)

LABEL	DESCRIPTION
Daylight Savings	<p>Daylight saving is a period from late spring to early fall when many countries set their clocks ahead of normal local time by one hour to give more daytime light in the evening.</p> <p>Select this option if you use Daylight Saving Time.</p>
Start Date	<p>Configure the day and time when Daylight Saving Time starts if you selected Enable Daylight Saving. The o'clock field uses the 24 hour format. Here are a couple of examples:</p> <p>Daylight Saving Time starts in most parts of the United States on the second Sunday of March. Each time zone in the United States starts using Daylight Saving Time at 2 A.M. local time. So in the United States you would select Second, Sunday, March and type 2 in the o'clock field.</p> <p>Daylight Saving Time starts in the European Union on the last Sunday of March. All of the time zones in the European Union start using Daylight Saving Time at the same moment (1 A.M. GMT or UTC). So in the European Union you would select Last, Sunday, March. The time you type in the o'clock field depends on your time zone. In Germany for instance, you would type 2 because Germany's time zone is one hour ahead of GMT or UTC (GMT+1).</p>
End Date	<p>Configure the day and time when Daylight Saving Time ends if you selected Enable Daylight Saving. The o'clock field uses the 24 hour format. Here are a couple of examples:</p> <p>Daylight Saving Time ends in the United States on the first Sunday of November. Each time zone in the United States stops using Daylight Saving Time at 2 A.M. local time. So in the United States you would select First, Sunday, November and type 2 in the o'clock field.</p> <p>Daylight Saving Time ends in the European Union on the last Sunday of October. All of the time zones in the European Union stop using Daylight Saving Time at the same moment (1 A.M. GMT or UTC). So in the European Union you would select Last, Sunday, October. The time you type in the o'clock field depends on your time zone. In Germany for instance, you would type 2 because Germany's time zone is one hour ahead of GMT or UTC (GMT+1).</p>
Apply	Click this to save your changes.
Cancel	Click this to restore your previously saved settings.

Firmware Upgrade

23.1 Overview

This chapter explains how to upload new firmware to your AMG1312-T Series. You can download new firmware releases from your nearest ZyXEL FTP site (or www.zyxel.com) to use to upgrade your device's performance.

Only use firmware for your device's specific model. Refer to the label on the bottom of your AMG1312-T Series.

23.2 The Firmware Screen

Click **Maintenance > Firmware Upgrade** to open the following screen. The upload process uses HTTP (Hypertext Transfer Protocol) and may take up to two minutes. After a successful upload, the system will reboot.

Do NOT turn off the AMG1312-T Series while firmware upload is in progress!

Figure 112 Maintenance > Firmware Upgrade

The following table describes the labels in this screen.

Table 87 Maintenance > Firmware Upgrade

LABEL	DESCRIPTION
Current Firmware Version	This is the present Firmware version.
File Path	Type in the location of the file you want to upload in this field or click Browse... to find it.
Browse...	Click this to find the .bin file you want to upload. Remember that you must decompress compressed (.zip) files before you can upload them.
Upload	Click this to begin the upload process. This process may take up to two minutes.

After you see the firmware updating screen, wait two minutes before logging into the AMG1312-T Series again.

Figure 113 Firmware Uploading

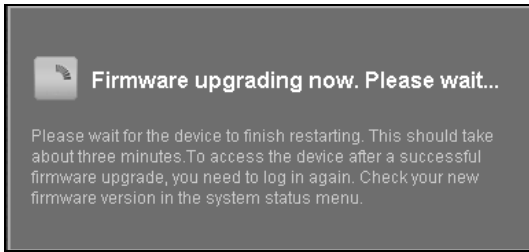

The AMG1312-T Series automatically restarts in this time causing a temporary network disconnect. In some operating systems, you may see the following icon on your desktop.

Figure 114 Network Temporarily Disconnected



After two minutes, log in again and check your new firmware version in the **Status** screen.

If the upload was not successful, an error screen will appear. Click **OK** to go back to the **Firmware Upgrade** screen.

Figure 115 Error Message

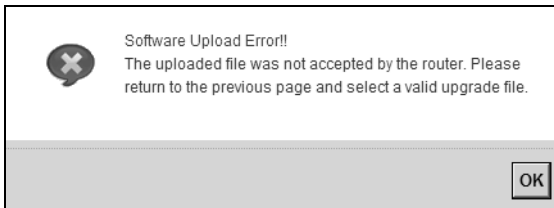

Backup/Restore

24.1 Overview

The **Backup/Restore** screen allows you to backup and restore device configurations. You can also reset your device settings back to the factory default.

24.2 The Backup/Restore Screen

Click **Maintenance > Backup/Restore**. Information related to factory defaults, backup configuration, and restoring configuration appears in this screen, as shown next.

Figure 116 Maintenance > Backup/Restore

The screenshot shows a web interface with three main sections:

- Backup Configuration:** A text instruction "Click Backup to save the current configuration of your system to your computer." followed by a "Backup" button.
- Restore Configuration:** A text instruction "To restore a previously saved configuration file to your system, browse to the location of the configuration file and click Upload." Below this is a "FilePath:" label, an empty text input field, a "Browse..." button, and an "Upload" button.
- Back to Factory Defaults:** A text instruction "Click Reset to clear all user-entered configuration information and return to factory defaults. After resetting, the LAN IP address will be 192.168.1.1 DHCP will be reset to server" followed by a "Reset" button.

Backup Configuration

Backup Configuration allows you to back up (save) the AMG1312-T Series's current configuration to a file on your computer. Once your AMG1312-T Series is configured and functioning properly, it is highly recommended that you back up your configuration file before making configuration changes. The backup configuration file will be useful in case you need to return to your previous settings.

Click **Backup** to save the AMG1312-T Series's current configuration to your computer.

Restore Configuration

Restore Configuration allows you to upload a new or previously saved configuration file from your computer to your AMG1312-T Series.

Table 88 Restore Configuration

LABEL	DESCRIPTION
File Path	Type in the location of the file you want to upload in this field or click Browse... to find it.
Browse...	Click this to find the file you want to upload. Remember that you must decompress compressed (.ZIP) files before you can upload them.
Upload	Click this to begin the upload process.
Reset	Click this to reset your device settings back to the factory default.

Do not turn off the AMG1312-T Series while configuration file upload is in progress.

After the AMG1312-T Series configuration has been restored successfully, the login screen appears. Login again to restart the AMG1312-T Series.

The AMG1312-T Series automatically restarts in this time causing a temporary network disconnect. In some operating systems, you may see the following icon on your desktop.

Figure 117 Network Temporarily Disconnected



If you restore the default configuration, you may need to change the IP address of your computer to be in the same subnet as that of the default device IP address (192.168.1.1). See [Appendix A on page 229](#) for details on how to set up your computer's IP address.

If the upload was not successful, an error screen will appear. Click **OK** to go back to the **Configuration** screen.

Reset to Factory Defaults

Click the **Reset** button to clear all user-entered configuration information and return the AMG1312-T Series to its factory defaults. The following warning screen appears.

Figure 118 Reset Warning Message

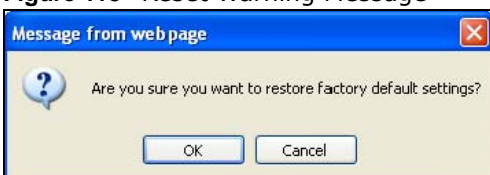

Wait until the AMG1312-T Series's login screen appears. You can also press the **RESET** button on the rear panel to reset the factory defaults of your AMG1312-T Series. Refer to [Section 1.7 on page 18](#) for more information on the **RESET** button.

24.3 The Reboot Screen

System restart allows you to reboot the AMG1312-T Series remotely without turning the power off. You may need to do this if the AMG1312-T Series hangs, for example.

Click **Maintenance > Reboot**. Click the **Reboot** button to have the AMG1312-T Series reboot. This does not affect the AMG1312-T Series's configuration.

Figure 119 Maintenance > Reboot

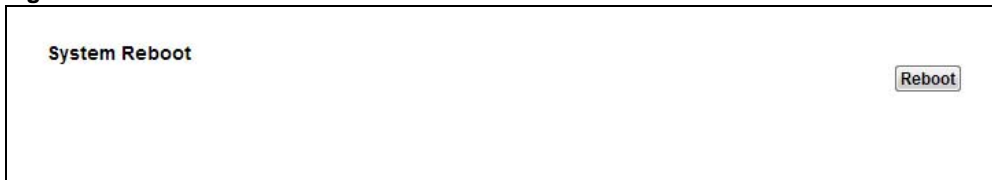

Remote Management

25.1 Overview

Remote management allows you to determine which services/protocols can access which AMG1312-T Series interface (if any) from which computers.

The following figure shows remote management of the AMG1312-T Series coming in from the WAN.

Figure 120 Remote Management From the WAN

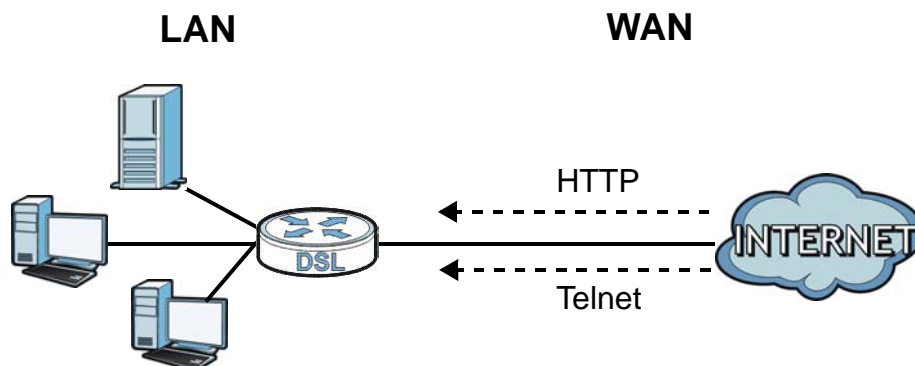

Note: When you configure remote management to allow management from the WAN, you still need to configure a IP filter rule to allow access.

You may manage your AMG1312-T Series from a remote location via:

- Internet (WAN only)
- LAN only
- LAN and WAN
- None (Disable)

To disable remote management of a service, select **Disable** in the corresponding **Service Access** field.

25.1.1 What You Can Do in the Remote Management Screens

- Use the **WWW** screen ([Section 25.2 on page 211](#)) to configure through which interface(s) and from which IP address(es) users can use HTTP to manage the AMG1312-T Series.
- Use the **Telnet** screen ([Section 25.3 on page 213](#)) to configure through which interface(s) and from which IP address(es) users can use Telnet to manage the AMG1312-T Series.
- Use the **FTP** screen ([Section 25.4 on page 213](#)) to configure through which interface(s) and from which IP address(es) users can use FTP to access the AMG1312-T Series.

- Your AMG1312-T Series can act as an SNMP agent, which allows a manager station to manage and monitor the AMG1312-T Series through the network. Use the **SNMP** screen (see [Section 25.5 on page 214](#)) to configure through which interface(s) and from which IP address(es) users can use SNMP to access the AMG1312-T Series.
- Use the **DNS** screen ([Section 25.6 on page 217](#)) to configure through which interface(s) and from which IP address(es) users can send DNS queries to the AMG1312-T Series.
- Use the **ICMP** screen ([Section 25.7 on page 217](#)) to set whether or not your AMG1312-T Series will respond to pings and probes for services that you have not made available.
- Use the **SSH** screen ([Section 25.8 on page 218](#)) to configure through which interface(s) and from which IP address(es) users can use SSH to manage the AMG1312-T Series.

25.1.2 What You Need to Know About Remote Management

Remote Management Limitations

Remote management does not work when:

- You have not enabled that service on the interface in the corresponding remote management screen.
- You have disabled that service in one of the remote management screens.
- The IP address in the **Secured Client IP Address** field does not match the client IP address. If it does not match, the AMG1312-T Series will disconnect the session immediately.
- There is a firewall rule that blocks it.

Remote Management and NAT

When NAT is enabled:

- Use the AMG1312-T Series's WAN IP address when configuring from the WAN.
- Use the AMG1312-T Series's LAN IP address when configuring from the LAN.

25.2 The WWW Screen

Use this screen to specify how to connect to the AMG1312-T Series from a web browser, such as Internet Explorer.

25.2.1 Configuring the WWW Screen

Click **Maintenance > RemoteMGMT** to display the **WWW** screen.

Figure 121 Maintenance > RemoteMGMT > WWW

The following table describes the labels in this screen.

Table 89 Maintenance > RemoteMGMT > WWW

LABEL	DESCRIPTION
Server Port	This displays the service port number for accessing the AMG1312-T Series using HTTP or HTTPS. If the number is grayed out, it is not editable.
Server Access	Select the interface(s) through which a computer may access the AMG1312-T Series using this service. Note: It is recommended if you are allowing WAN access even temporarily to change the default password (in Maintenance > User Account). To allow access from the WAN, you will need to configure a WAN to Router firewall rule. See Section 4.1 on page 34 for information on configuring firewall rules.
Secured Client IP Address	A secured client is a “trusted” computer that is allowed to communicate with the AMG1312-T Series using this service. Select All to allow any computer to access the AMG1312-T Series using this service. Choose Range to just allow the computer(s) with an IP address in the range that you specify to access the AMG1312-T Series using this service.
Apply	Click this to save your changes.
Cancel	Click this to restore your previously saved settings.

25.3 The Telnet Screen

You can use Telnet to access the AMG1312-T Series's command line interface. Specify which interfaces allow Telnet access and from which IP address the access can come.

Click **Maintenance > RemoteMGMT > Telnet** tab to display the screen as shown.

Figure 122 Maintenance > RemoteMGMT > Telnet

Server Port: 23

Server Access: LAN

Secured Client IP Address: All

Range

From: 0.0.0.0 To: 0.0.0.0

From: 0.0.0.0 To: 0.0.0.0

From: 0.0.0.0 To: 0.0.0.0

Note:

- The session will be reset after apply.
- The Range IP could be IPv4 or IPv6.

Apply Cancel

The following table describes the labels in this screen.

Table 90 Maintenance > RemoteMGMT > Telnet

LABEL	DESCRIPTION
Server Port	This displays the service port number for accessing the AMG1312-T Series. If the number is grayed out, it is not editable.
Server Access	Select the interface(s) through which a computer may access the AMG1312-T Series using this service. Note: It is recommended if you are allowing WAN access even temporarily to change the default password (in Maintenance > User Account). To allow access from the WAN, you will need to configure a WAN to Router firewall rule. See Firewall Section on page 168 for information on configuring firewall rules.
Secured Client IP Address	A secured client is a "trusted" computer that is allowed to communicate with the AMG1312-T Series using this service. Select All to allow any computer to access the AMG1312-T Series using this service. Choose Range to just allow the computer(s) with an IP address in the range that you specify to access the AMG1312-T Series using this service.
Apply	Click this to save your changes.
Cancel	Click this to restore your previously saved settings.

25.4 The FTP Screen

You can use FTP (File Transfer Protocol) to upload and download the AMG1312-T Series's firmware and configuration files. Please see the User's Guide chapter on firmware and configuration file maintenance for details. To use this feature, your computer must have an FTP client.

Use this screen to specify which interfaces allow FTP access and from which IP address the access can come. To change your AMG1312-T Series's FTP settings, click **Maintenance > RemoteMGMT > FTP**. The screen appears as shown.

Figure 123 Maintenance > RemoteMGMT > FTP

Server Port: 21

Server Access: LAN

Secured Client IP Address: All

Range

From: 0.0.0.0 To: 0.0.0.0

From: 0.0.0.0 To: 0.0.0.0

From: 0.0.0.0 To: 0.0.0.0

Note :

- 1.The session will be reset after apply.
- 2.The Range IP could be IPv4 or IPv6.

Apply Cancel

The following table describes the labels in this screen.

Table 91 Maintenance > RemoteMGMT > FTP

LABEL	DESCRIPTION
Server Port	This displays the service port number for accessing the AMG1312-T Series. If the number is grayed out, it is not editable.
Server Access	Select the interface(s) through which a computer may access the AMG1312-T Series using this service.
Secured Client IP Address	A secured client is a "trusted" computer that is allowed to communicate with the AMG1312-T Series using this service. Select All to allow any computer to access the AMG1312-T Series using this service. Choose Range to just allow the computer(s) with an IP address in the range that you specify to access the AMG1312-T Series using this service.
Apply	Click this to save your changes.
Cancel	Click this to restore your previously saved settings.

25.5 The SNMP Screen

Simple Network Management Protocol is a protocol used for exchanging management information between network devices. Your AMG1312-T Series supports SNMP agent functionality, which allows a manager station to manage and monitor the AMG1312-T Series through the network. The AMG1312-T Series supports SNMP version one (SNMPv1) and version two (SNMPv2c). The next figure illustrates an SNMP management operation.

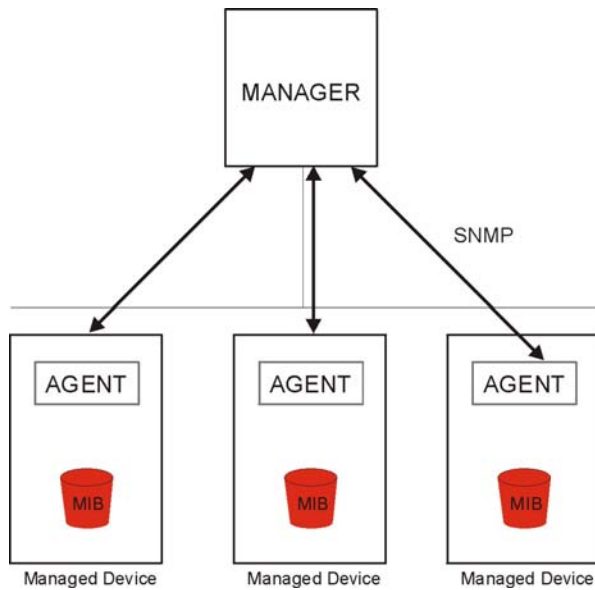
Figure 124 SNMP Management Model

An SNMP managed network consists of two main types of component: agents and a manager.

An agent is a management software module that resides in a managed device (the AMG1312-T Series). An agent translates the local management information from the managed device into a form compatible with SNMP. The manager is the console through which network administrators perform network management functions. It executes applications that control and monitor managed devices.

The managed devices contain object variables/managed objects that define each piece of information to be collected about a device. Examples of variables include such as number of packets received, node port status etc. A Management Information Base (MIB) is a collection of managed objects. SNMP allows a manager and agents to communicate for the purpose of accessing these objects.

25.5.1 Configuring SNMP

To change your AMG1312-T Series's SNMP settings, click **Maintenance > RemoteMGMT > SNMP** tab. The screen appears as shown.

Figure 125 Maintenance > RemoteMGMT > SNMP

Server Port: 161

Server Access: LAN

SNMPv3: Enable Disable

Secured Client IP Address: All

Range

From: 0.0.0.0 To: 0.0.0.0

From: 0.0.0.0 To: 0.0.0.0

From: 0.0.0.0 To: 0.0.0.0

SNMP Setup

Get Community: public

Set Community: public

Trap Community: public

IPv4 Trap Destination: 0.0.0.0

IPv6 Trap Destination: ::1

Note :

- 1.The session will be reset after apply.
- 2.The Range IP could be IPv4 or IPv6.

Apply Cancel

The following table describes the labels in this screen.

Table 92 Maintenance > RemoteMGMT > SNMP

LABEL	DESCRIPTION
Server Port	This displays the port the SNMP agent listens on. If the number is grayed out, it is not editable.
Server Access	Select the interface(s) through which a computer may access the AMG1312-T Series using this service.
Secured Client IP Address	A secured client is a “trusted” computer that is allowed to access the SNMP agent on the AMG1312-T Series. Select All to allow any computer to access the SNMP agent. Choose Range to just allow the computer(s) with an IP address in the range that you specify to access the AMG1312-T Series using this service.
Get Community	Enter the Get Community , which is the password for the incoming Get and GetNext requests from the management station. The default is public and allows all requests.
Set Community	Enter the Set community , which is the password for incoming Set requests from the management station. The default is public and allows all requests.
Apply	Click Apply to save your changes back to the AMG1312-T Series.
Cancel	Click Cancel to begin configuring this screen afresh.

25.6 The DNS Screen

Use DNS (Domain Name System) to map a domain name to its corresponding IP address and vice versa.

Use this screen to set from which IP address the AMG1312-T Series will accept DNS queries and on which interface it can send them your AMG1312-T Series's DNS settings. This feature is not available when the AMG1312-T Series is set to bridge mode. Click **Maintenance > RemoteMGMT > DNS** to change your AMG1312-T Series's DNS settings.

Figure 126 Maintenance > RemoteMGMT > DNS

The screenshot shows the DNS configuration interface. It includes a text input for 'Server Port' with the value '53', a dropdown for 'Server Access' set to 'LAN', and radio buttons for 'Secured Client IP Address' with 'All' selected. Below are three 'Range' IP address sections, each with 'From' and 'To' text boxes, all containing '0.0.0.0'. A 'Note' section contains the text '1.The Range IP could be IPv4 or IPv6.'. At the bottom right are 'Apply' and 'Cancel' buttons.

The following table describes the labels in this screen.

Table 93 Maintenance > RemoteMGMT > DNS

LABEL	DESCRIPTION
Server Port	This displays the service port number for accessing the AMG1312-T Series. If the number is grayed out, it is not editable.
Access Status	Select the interface(s) through which a computer may send DNS queries to the AMG1312-T Series.
Secured Client IP Address	A secured client is a "trusted" computer that is allowed to send DNS queries to the AMG1312-T Series. Select All to allow any computer to send DNS queries to the AMG1312-T Series. Choose Range to just allow the computer(s) with an IP address in the range that you specify to send DNS queries to the AMG1312-T Series.
Apply	Click this to save your changes.
Cancel	Click this to restore your previously saved settings.

25.7 The ICMP Screen

To change your AMG1312-T Series's security settings, click **Maintenance > RemoteMGMT > ICMP**. The screen appears as shown.

If an outside user attempts to probe an unsupported port on your AMG1312-T Series, an ICMP response packet is automatically returned. This allows the outside user to know the AMG1312-T Series exists. Your AMG1312-T Series supports anti-probing, which prevents the ICMP response

packet from being sent. This keeps outsiders from discovering your AMG1312-T Series when unsupported ports are probed.

Note: If you want your device to respond to pings and requests for unauthorized services, you will also need to configure the firewall accordingly by disabling SPI.

Figure 127 Maintenance > RemoteMGMT > ICMP

Respond to Ping on: LAN

Secured Client IP Address: All

Range

From: 0.0.0.0 To: 0.0.0.0

From: 0.0.0.0 To: 0.0.0.0

From: 0.0.0.0 To: 0.0.0.0

Note:

1.The Range IP could be IPv4 or IPv6.

Apply Cancel

The following table describes the labels in this screen.

Table 94 Maintenance > RemoteMGMT > ICMP

LABEL	DESCRIPTION
Respond to Ping on	The AMG1312-T Series will not respond to any incoming Ping requests when Disable is selected. Select LAN to reply to incoming LAN Ping requests. Select WAN to reply to incoming WAN Ping requests. Otherwise select LAN & WAN to reply to both incoming LAN and WAN Ping requests.
Secured Client IP Address	A secured client is a "trusted" computer that is allowed to send Ping requests to the AMG1312-T Series. Select All to allow any computer to send Ping requests to the AMG1312-T Series. Choose Range to just allow the computer(s) with an IP address in the range that you specify to send Ping requests to the AMG1312-T Series.
Apply	Click this to save your changes.
Cancel	Click this to restore your previously saved settings.

25.8 The SSH Screen

You can use Secure SHell (SSH) to securely access the AMG1312-T Series's command line interface. Specify which interfaces allow SSH access and from which IP address the access can come. SSH is a secure communication protocol that combines authentication and data encryption to provide secure encrypted communication between two hosts over an unsecured network.

Click **Maintenance > RemoteMGMT > SSH** tab to display the screen as shown.

Figure 128 Maintenance > RemoteMGMT > SSH

Server Port: 22

Server Access: LAN

Secured Client IP Address: All

Range

From: 0.0.0.0 To: 0.0.0.0

From: 0.0.0.0 To: 0.0.0.0

From: 0.0.0.0 To: 0.0.0.0

Note :

1.The Range IP could be IPv4 or IPv6.

Apply Cancel

The following table describes the labels in this screen.

Table 95 Maintenance > RemoteMGMT > SSH

LABEL	DESCRIPTION
Server Port	This displays the service port number for accessing the AMG1312-T Series. If the number is grayed out, it is not editable.
Server Access	Select the interface(s) through which a computer may access the AMG1312-T Series using this service. Note: It is recommended if you are allowing WAN access even temporarily to change the default password (in Maintenance > User Account). To allow access from the WAN, you will need to configure a WAN to Router firewall rule. See Firewall Section on page 168 for information on configuring firewall rules.
Secured Client IP Address	A secured client is a “trusted” computer that is allowed to communicate with the AMG1312-T Series using this service. Select All to allow any computer to access the AMG1312-T Series using this service. Choose Range to just allow the computer(s) with an IP address in the range that you specify to access the AMG1312-T Series using this service.
Apply	Click this to save your changes.
Cancel	Click this to restore your previously saved settings.

25.8.1 SSH Example

This section shows an example using a graphical interface SSH client program to remotely access the ZyxEL Device. The configuration and connection steps are similar for most SSH client programs. Refer to your SSH client program user’s guide.

- 1 Enter the IP address and port number. Select **SSH**.

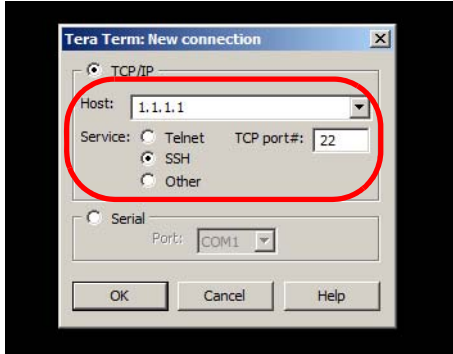

- 2 A window displays prompting you to store the host key in your computer. Click **Yes** to continue.



- 3 Enter your user name and password.

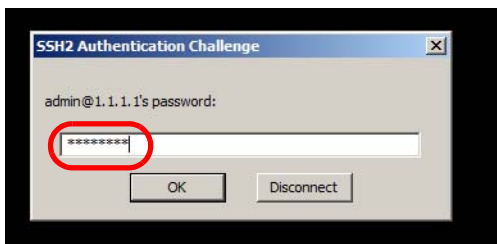
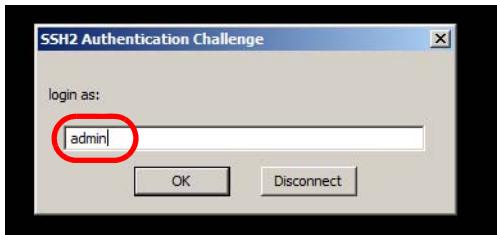

- 4 The command line interface displays.

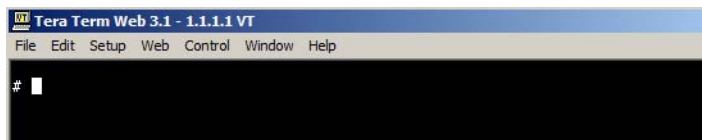

Diagnostic

26.1 Overview

These read-only screens display information to help you identify problems with the AMG1312-T Series.

26.1.1 What You Can Do in the Diagnostic Screens

- Use the **Ping** screen ([Section 26.2 on page 221](#)) to ping an IP address.
- Use the **DSL Line** screen ([Section 26.3 on page 222](#)) to view the DSL line statistics and reset the ADSL line.

26.2 The General Screen

Use this screen to ping an IP address. Click **Maintenance > Diagnostic > Ping** to open the screen shown next.

Figure 129 Maintenance > Diagnostic > Ping

The following table describes the fields in this screen.

Table 96 Maintenance > Diagnostic > Ping

LABEL	DESCRIPTION
	Type the IP address of a computer that you want to ping in order to test a connection.
Ping	Click this to ping the IP address that you entered.
PingV6	Click this to ping the IPv6 address that you entered.
TracerouteV6	Click this to display the route path and transmission delays between the AMG1312-T Series to the IPv6 address that you entered.

26.3 The DSL Line Screen

Use this screen to view the DSL line statistics and reset the ADSL line. Click **Maintenance > Diagnostic > DSL Line** to open the screen shown next.

Figure 130 Maintenance > Diagnostic > DSL Line

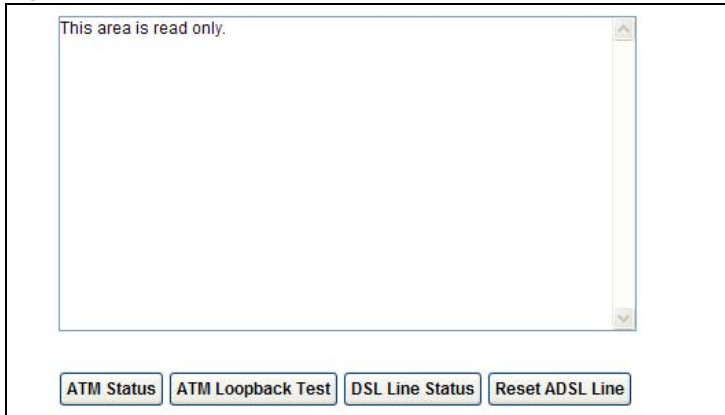

The following table describes the fields in this screen.

Table 97 Maintenance > Diagnostic > DSL Line

LABEL	DESCRIPTION
ATM Status	<p>Click this to view your DSL connection's Asynchronous Transfer Mode (ATM) statistics. ATM is a networking technology that provides high-speed data transfer. ATM uses fixed-size packets of information called cells. With ATM, a high QoS (Quality of Service) can be guaranteed.</p> <p>The (Segmentation and Reassembly) SAR driver translates packets into ATM cells. It also receives ATM cells and reassembles them into packets.</p> <p>These counters are set back to zero whenever the device starts up.</p> <p>inPkts is the number of good ATM cells that have been received.</p> <p>inDiscards is the number of received ATM cells that were rejected.</p> <p>inF4Pkts is the number of ATM Operations, Administration, and Management (OAM) F4 cells that have been received. See ITU recommendation I.610 for more on OAM for ATM.</p> <p>inF5Pkts is the number of ATM OAM F5 cells that have been received.</p> <p>outPkts is the number of ATM cells that have been sent.</p> <p>outDiscards is the number of ATM cells sent that were rejected.</p> <p>outF4Pkts is the number of ATM OAM F4 cells that have been sent.</p> <p>outF5Pkts is the number of ATM OAM F5 cells that have been sent.</p>
ATM Loopback Test	<p>Click this to start the ATM loopback test. Make sure you have configured at least one PVC with proper VPIs/VCI's before you begin this test. The AMG1312-T Series sends an OAM F5 packet to the DSLAM/ATM switch and then returns it (loops it back) to the AMG1312-T Series. The ATM loopback test is useful for troubleshooting problems with the DSLAM and ATM network.</p>

Table 97 Maintenance > Diagnostic > DSL Line (continued)

LABEL	DESCRIPTION
DSL Line Status	<p>Click this to view statistics about the DSL connections.</p> <p>noise margin downstream is the signal to noise ratio for the downstream part of the connection (coming into the AMG1312-T Series from the ISP). It is measured in decibels. The higher the number the more signal and less noise there is.</p> <p>output power upstream is the amount of power (in decibels) that the AMG1312-T Series is using to transmit to the ISP.</p> <p>attenuation downstream is the reduction in amplitude (in decibels) of the DSL signal coming into the AMG1312-T Series from the ISP.</p> <p>Discrete Multi-Tone (DMT) modulation divides up a line's bandwidth into sub-carriers (sub-channels) of 4.3125 KHz each called tones. The rest of the display is the line's bit allocation. This is displayed as the number (in hexadecimal format) of bits transmitted for each tone. This can be used to determine the quality of the connection, whether a given sub-carrier loop has sufficient margins to support certain ADSL transmission rates, and possibly to determine whether particular specific types of interference or line attenuation exist. Refer to the ITU-T G.992.1 recommendation for more information on DMT.</p> <p>The better (or shorter) the line, the higher the number of bits transmitted for a DMT tone. The maximum number of bits that can be transmitted per DMT tone is 15. There will be some tones without any bits as there has to be space between the upstream and downstream channels.</p>
Reset ADSL Line	<p>Click this to reinitialize the ADSL line. The large text box above then displays the progress and results of this operation, for example:</p> <pre> "Start to reset ADSL Loading ADSL modem F/W... Reset ADSL Line Successfully!" </pre>

Troubleshooting

This chapter offers some suggestions to solve problems you might encounter. The potential problems are divided into the following categories.

- [Power, Hardware Connections, and LEDs](#)
- [AMG1312-T Series Access and Login](#)
- [Internet Access](#)

27.1 Power, Hardware Connections, and LEDs

The AMG1312-T Series does not turn on. None of the LEDs turn on.

- 1 Make sure the AMG1312-T Series is turned on.
- 2 Make sure you are using the power adaptor or cord included with the AMG1312-T Series.
- 3 Make sure the power adaptor or cord is connected to the AMG1312-T Series and plugged in to an appropriate power source. Make sure the power source is turned on.
- 4 Turn the AMG1312-T Series off and on.
- 5 If the problem continues, contact the vendor.

One of the LEDs does not behave as expected.

- 1 Make sure you understand the normal behavior of the LED. [Section 1.5 on page 16](#)

LABEL	DESCRIPTION
WPS LED	Green: successful connection
	Off: connection failure
WIFI LED	Green: WIFI active
	Off: WIFI inactive

- 2 Check the hardware connections.
- 3 Inspect your cables for damage. Contact the vendor to replace any damaged cables.

- 4 Turn the AMG1312-T Series off and on.
- 5 If the problem continues, contact the vendor.

27.2 AMG1312-T Series Access and Login

I forgot the IP address for the AMG1312-T Series.

- 1 The default IP address is **192.168.1.1**.
- 2 If you changed the IP address and have forgotten it, you might get the IP address of the AMG1312-T Series by looking up the IP address of the default gateway for your computer. To do this in most Windows computers, click **Start > Run**, enter **cmd**, and then enter **ipconfig**. The IP address of the **Default Gateway** might be the IP address of the AMG1312-T Series (it depends on the network), so enter this IP address in your Internet browser.
- 3 If this does not work, you have to reset the device to its factory defaults. See [Section 1.7 on page 18](#).

I forgot the password.

- 1 The default admin user name and password can be found on the cover of this User's Guide.
- 2 If this does not work, you have to reset the device to its factory defaults. See [Section 1.7 on page 18](#).

I cannot see or access the **Login** screen for the web configurator.

- 1 Make sure you are using the correct IP address.
 - The default IP address is **192.168.1.1**.
 - If you changed the IP address ([Section 8.2 on page 117](#)), use the new IP address.
 - If you changed the IP address and have forgotten it, see the troubleshooting suggestions for [I forgot the IP address for the AMG1312-T Series](#).
- 2 Check the hardware connections, and make sure the LEDs are behaving as expected. See the Quick Start Guide.
- 3 Make sure your Internet browser does not block pop-up windows and has JavaScripts and Java enabled. See [Appendix C on page 257](#).

- 4 Reset the device to its factory defaults, and try to access the AMG1312-T Series with the default IP address. See [Section 1.7 on page 18](#).
- 5 If the problem continues, contact the network administrator or vendor, or try one of the advanced suggestions.

Advanced Suggestions

- Try to access the AMG1312-T Series using another service, such as Telnet. If you can access the AMG1312-T Series, check the remote management settings and firewall rules to find out why the AMG1312-T Series does not respond to HTTP.
- If your computer is connected to the **DSL** port or is connected wirelessly, use a computer that is connected to a **ETHERNET** port.

I can see the **Login** screen, but I cannot log in to the AMG1312-T Series.

- 1 Make sure you have entered the password correctly. The default user and default admin password can be found on the cover page of this User's Guide. The field is case-sensitive, so make sure [Caps Lock] is not on.
- 2 You cannot log in to the web configurator while someone is using Telnet to access the AMG1312-T Series. Log out of the AMG1312-T Series in the other session, or ask the person who is logged in to log out.
- 3 Turn the AMG1312-T Series off and on.
- 4 If this does not work, you have to reset the device to its factory defaults. See [Section 1.7 on page 18](#).

I cannot Telnet to the AMG1312-T Series.

See the troubleshooting suggestions for [I cannot see or access the Login screen for the web configurator](#). Ignore the suggestions about your browser.

I cannot use FTP to upload / download the configuration file. / I cannot use FTP to upload new firmware.

See the troubleshooting suggestions for [I cannot see or access the Login screen for the web configurator](#). Ignore the suggestions about your browser.

27.3 Internet Access

I cannot access the Internet.

- 1 Check the hardware connections, and make sure the LEDs are behaving as expected. See the Quick Start Guide and [Section 27.1 on page 225](#).
- 2 Make sure you entered your ISP account information correctly in the wizard. These fields are case-sensitive, so make sure [Caps Lock] is not on.
- 3 If you are trying to access the Internet wirelessly, make sure the wireless settings in the wireless client are the same as the settings in the AP.
- 4 If you are trying to access the Internet wirelessly, make sure you enabled the wireless LAN and have selected the correct country and channel in which your AMG1312-T Series operates in the **Wireless LAN > AP** screen.
- 5 Disconnect all the cables from your device, and follow the directions in the Quick Start Guide again.
- 6 If the problem continues, contact your ISP.

I cannot access the Internet anymore. I had access to the Internet (with the AMG1312-T Series), but my Internet connection is not available anymore.

- 1 Check the hardware connections, and make sure the LEDs are behaving as expected. See the Quick Start Guide and [Section 27.1 on page 225](#).
- 2 Turn the AMG1312-T Series off and on.
- 3 If the problem continues, contact your ISP.

The Internet connection is slow or intermittent.

- 1 There might be a lot of traffic on the network. Look at the LEDs, and check [Section 27.1 on page 225](#). If the AMG1312-T Series is sending or receiving a lot of information, try closing some programs that use the Internet, especially peer-to-peer applications.
- 2 Check the signal strength. If the signal strength is low, try moving your computer closer to the AMG1312-T Series if possible, and look around to see if there are any devices that might be interfering with the wireless network (for example, microwaves, other wireless networks, and so on).
- 3 Turn the AMG1312-T Series off and on.

- 4 If the problem continues, contact the network administrator or vendor, or try one of the advanced suggestions.

Advanced Suggestions

- Check the settings for QoS. If it is disabled, you might consider activating it. If it is enabled, you might consider raising or lowering the priority for some applications.

Setting up Your Computer's IP Address

All computers must have a 10M or 100M Ethernet adapter and TCP/IP installed.

Windows 95/98/Me/NT/2000/XP/Vista, Macintosh OS 7 and later operating systems and all versions of UNIX/LINUX include the software components you need to install and use TCP/IP on your computer. Windows 3.1 requires the purchase of a third-party TCP/IP application package.

TCP/IP should already be installed on computers using Windows NT/2000/XP, Macintosh OS 7 and later operating systems.

After the appropriate TCP/IP components are installed, configure the TCP/IP settings in order to "communicate" with your network.

If you manually assign IP information instead of using dynamic assignment, make sure that your computers have IP addresses that place them in the same subnet as the AMG1312-T Series's LAN port.

Windows 95/98/Me

Click **Start**, **Settings**, **Control Panel** and double-click the **Network** icon to open the **Network** window.

Figure 131 WIndows 95/98/Me: Network: Configuration

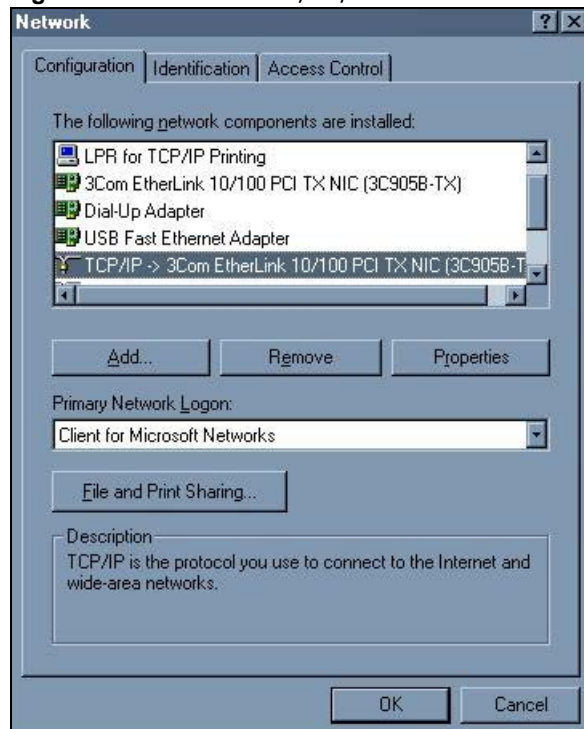

Installing Components

The **Network** window **Configuration** tab displays a list of installed components. You need a network adapter, the TCP/IP protocol and Client for Microsoft Networks.

If you need the adapter:

- 1 In the **Network** window, click **Add**.
- 2 Select **Adapter** and then click **Add**.
- 3 Select the manufacturer and model of your network adapter and then click **OK**.

If you need TCP/IP:

- 1 In the **Network** window, click **Add**.
- 2 Select **Protocol** and then click **Add**.
- 3 Select **Microsoft** from the list of **manufacturers**.
- 4 Select **TCP/IP** from the list of network protocols and then click **OK**.

If you need Client for Microsoft Networks:

- 1 Click **Add**.
- 2 Select **Client** and then click **Add**.
- 3 Select **Microsoft** from the list of manufacturers.
- 4 Select **Client for Microsoft Networks** from the list of network clients and then click **OK**.
- 5 Restart your computer so the changes you made take effect.

Configuring

- 1 In the **Network** window **Configuration** tab, select your network adapter's TCP/IP entry and click **Properties**
- 2 Click the **IP Address** tab.
 - If your IP address is dynamic, select **Obtain an IP address automatically**.
 - If you have a static IP address, select **Specify an IP address** and type your information into the **IP Address** and **Subnet Mask** fields.

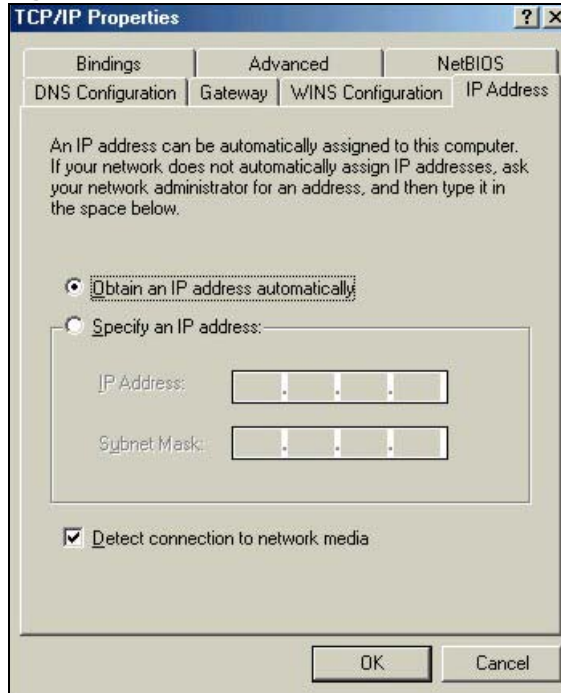
Figure 132 Windows 95/98/Me: TCP/IP Properties: IP Address

3 Click the **DNS Configuration** tab.

- If you do not know your DNS information, select **Disable DNS**.
- If you know your DNS information, select **Enable DNS** and type the information in the fields below (you may not need to fill them all in).

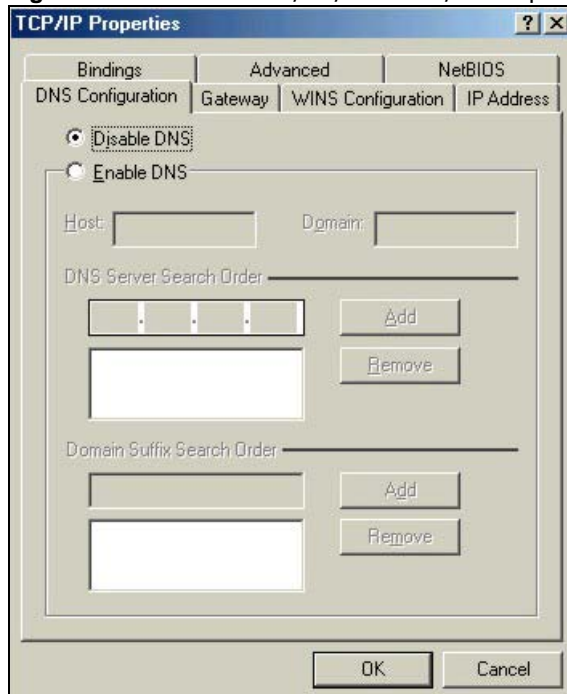
Figure 133 Windows 95/98/Me: TCP/IP Properties: DNS Configuration

4 Click the **Gateway** tab.

- If you do not know your gateway's IP address, remove previously installed gateways.
 - If you have a gateway IP address, type it in the **New gateway field** and click **Add**.
- 5 Click **OK** to save and close the **TCP/IP Properties** window.
 - 6 Click **OK** to close the **Network** window. Insert the Windows CD if prompted.
 - 7 Turn on your AMG1312-T Series and restart your computer when prompted.

Verifying Settings

- 1 Click **Start** and then **Run**.
- 2 In the **Run** window, type "winipcfg" and then click **OK** to open the **IP Configuration** window.
- 3 Select your network adapter. You should see your computer's IP address, subnet mask and default gateway.

Windows 2000/NT/XP

The following example figures use the default Windows XP GUI theme.

- 1 Click **start** (**Start** in Windows 2000/NT), **Settings**, **Control Panel**.

Figure 134 Windows XP: Start Menu

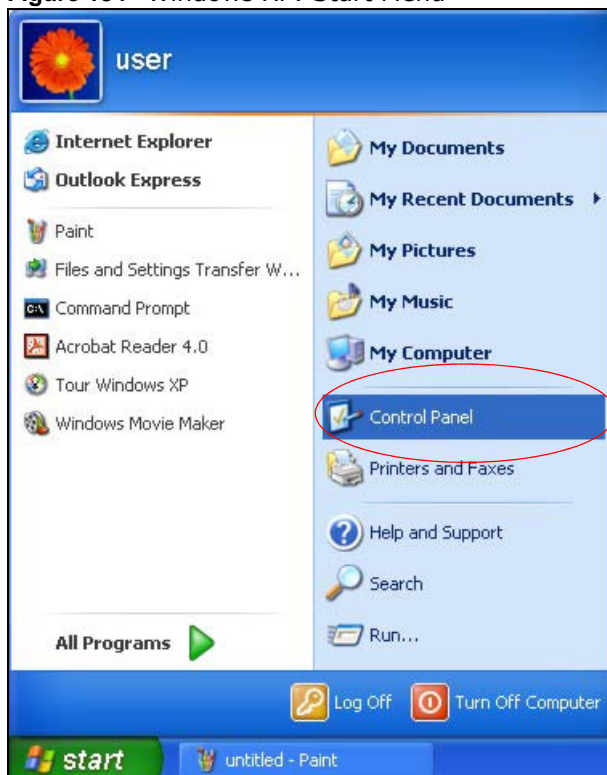

- 2 In the **Control Panel**, double-click **Network Connections** (**Network and Dial-up Connections** in Windows 2000/NT).

Figure 135 Windows XP: Control Panel

- 3 Right-click **Local Area Connection** and then click **Properties**.

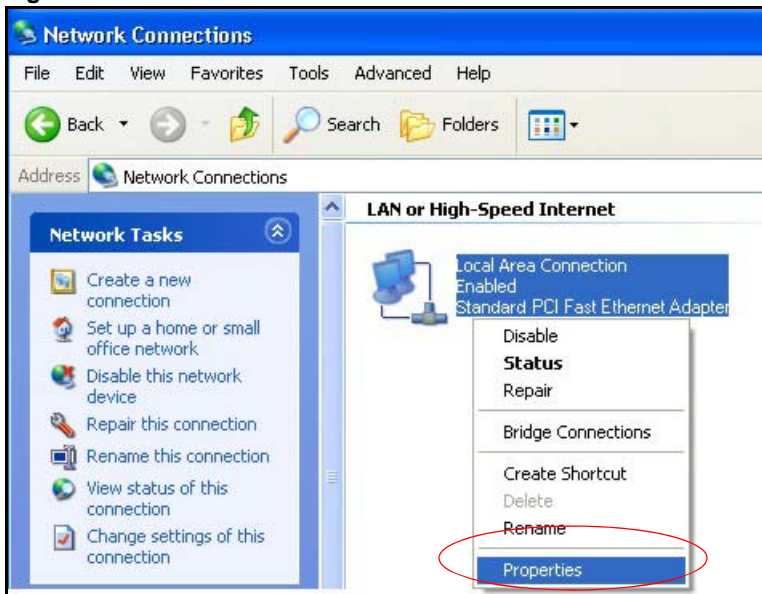
Figure 136 Windows XP: Control Panel: Network Connections: Properties

- 4 Select **Internet Protocol (TCP/IP)** (under the **General** tab in Win XP) and then click **Properties**.

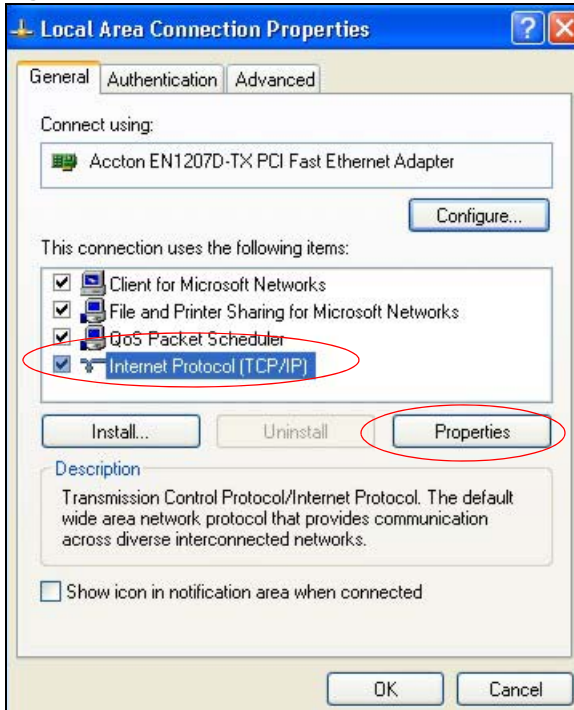
Figure 137 Windows XP: Local Area Connection Properties

- 5 The **Internet Protocol TCP/IP Properties** window opens (the **General** tab in Windows XP).
- If you have a dynamic IP address click **Obtain an IP address automatically**.
 - If you have a static IP address click **Use the following IP Address** and fill in the **IP address**, **Subnet mask**, and **Default gateway** fields.
 - Click **Advanced**.

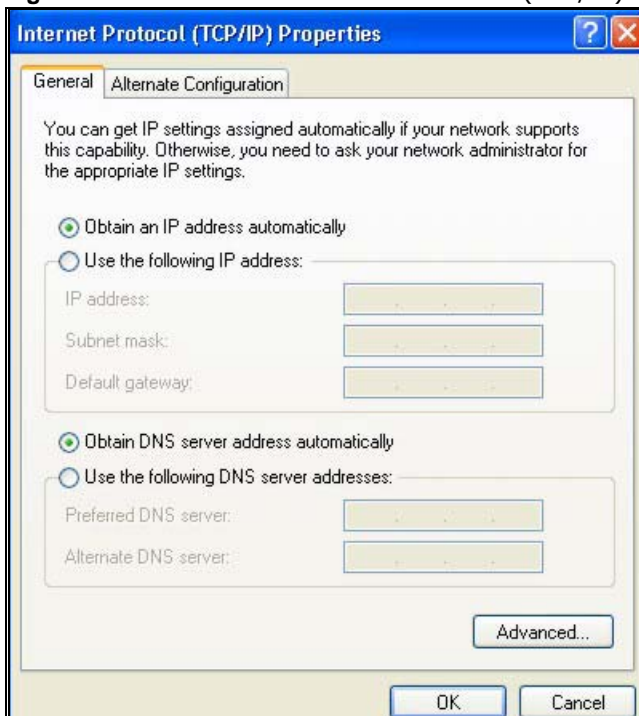
Figure 138 Windows XP: Internet Protocol (TCP/IP) Properties

- 6 If you do not know your gateway's IP address, remove any previously installed gateways in the **IP Settings** tab and click **OK**.

Do one or more of the following if you want to configure additional IP addresses:

- In the **IP Settings** tab, in IP addresses, click **Add**.
- In **TCP/IP Address**, type an IP address in **IP address** and a subnet mask in **Subnet mask**, and then click **Add**.
- Repeat the above two steps for each IP address you want to add.
- Configure additional default gateways in the **IP Settings** tab by clicking **Add** in **Default gateways**.
- In **TCP/IP Gateway Address**, type the IP address of the default gateway in **Gateway**. To manually configure a default metric (the number of transmission hops), clear the **Automatic metric** check box and type a metric in **Metric**.
- Click **Add**.
- Repeat the previous three steps for each default gateway you want to add.
- Click **OK** when finished.

Figure 139 Windows XP: Advanced TCP/IP Properties

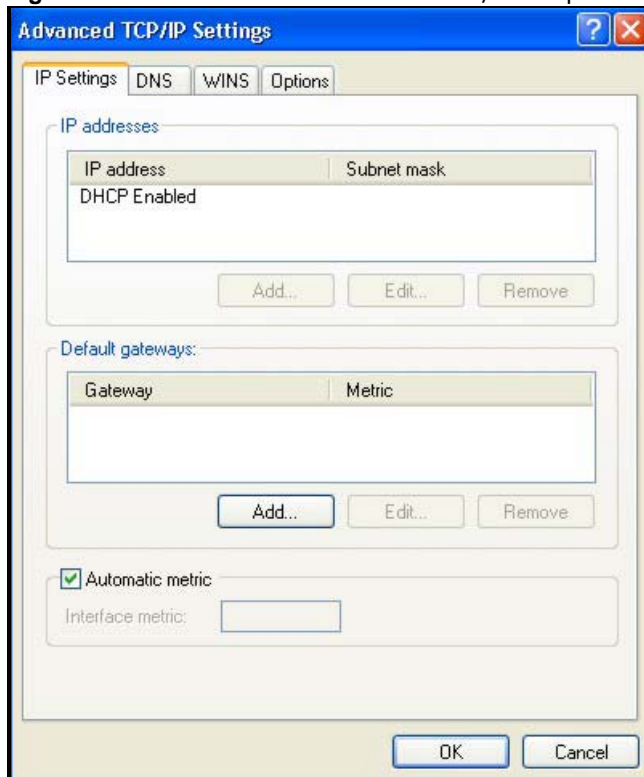

- 7 In the **Internet Protocol TCP/IP Properties** window (the **General** tab in Windows XP):
- Click **Obtain DNS server address automatically** if you do not know your DNS server IP address(es).
 - If you know your DNS server IP address(es), click **Use the following DNS server addresses**, and type them in the **Preferred DNS server** and **Alternate DNS server** fields. If you have previously configured DNS servers, click **Advanced** and then the **DNS** tab to order them.

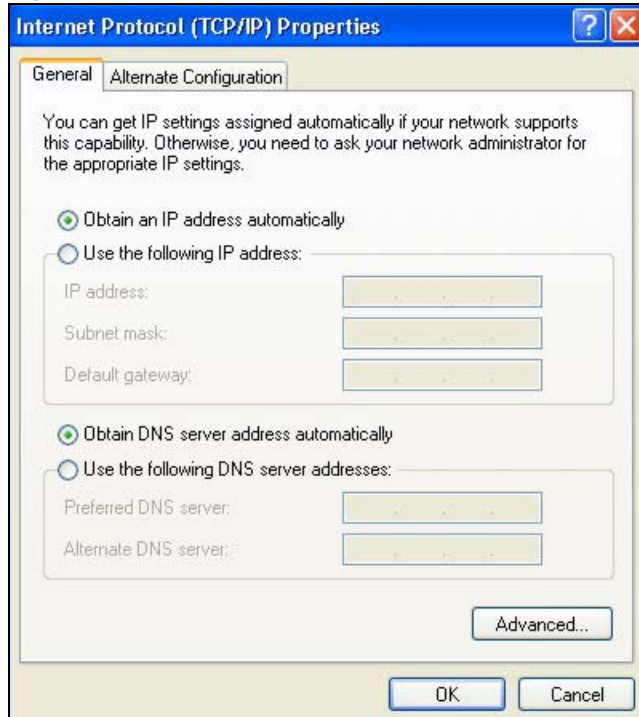
Figure 140 Windows XP: Internet Protocol (TCP/IP) Properties

- 8 Click **OK** to close the **Internet Protocol (TCP/IP) Properties** window.
- 9 Click **Close (OK in Windows 2000/NT)** to close the **Local Area Connection Properties** window.
- 10 Close the **Network Connections** window (**Network and Dial-up Connections** in Windows 2000/NT).
- 11 Turn on your AMG1312-T Series and restart your computer (if prompted).

Verifying Settings

- 1 Click **Start, All Programs, Accessories** and then **Command Prompt**.
- 2 In the **Command Prompt** window, type "ipconfig" and then press [ENTER]. You can also open **Network Connections**, right-click a network connection, click **Status** and then click the **Support** tab.

Windows Vista

This section shows screens from Windows Vista Enterprise Version 6.0.

- 1 Click the **Start** icon, **Control Panel**.

Figure 141 Windows Vista: Start Menu



- 2 In the **Control Panel**, double-click **Network and Internet**.

Figure 142 Windows Vista: Control Panel

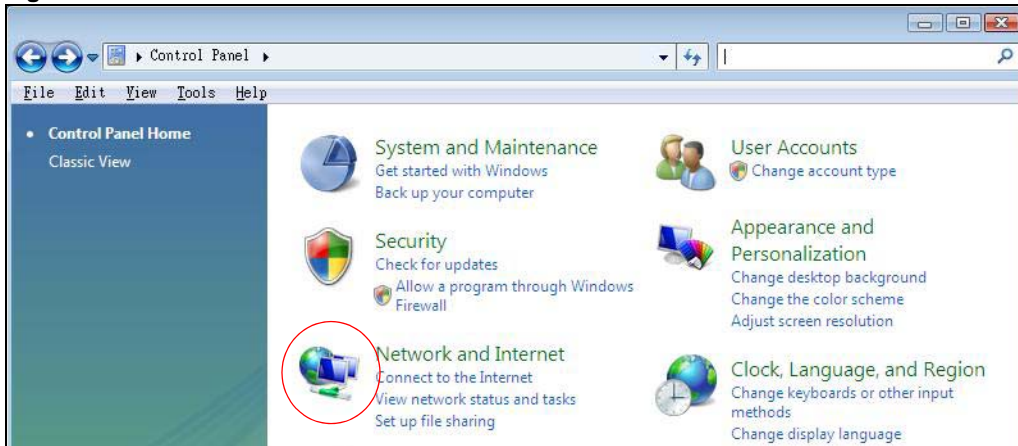

- 3 Click **Network and Sharing Center**.

Figure 143 Windows Vista: Network And Internet

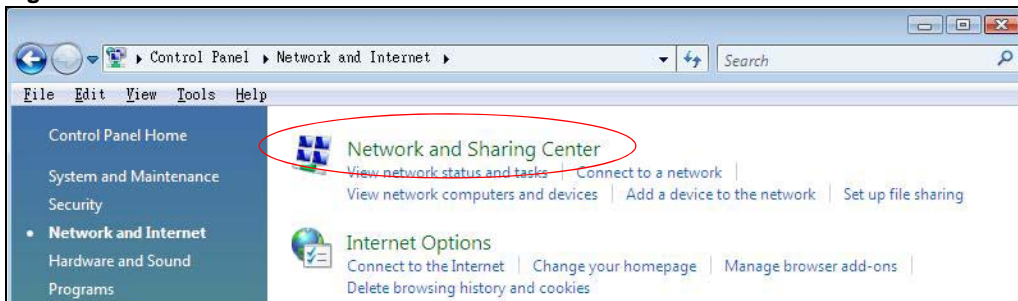

- 4 Click **Manage network connections**.

Figure 144 Windows Vista: Network and Sharing Center

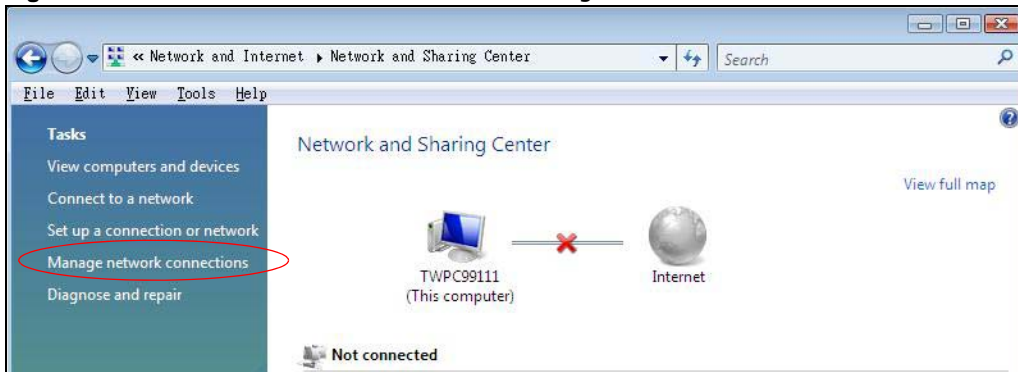

- 5 Right-click **Local Area Connection** and then click **Properties**.

Note: During this procedure, click **Continue** whenever Windows displays a screen saying that it needs your permission to continue.

Figure 145 Windows Vista: Network and Sharing Center

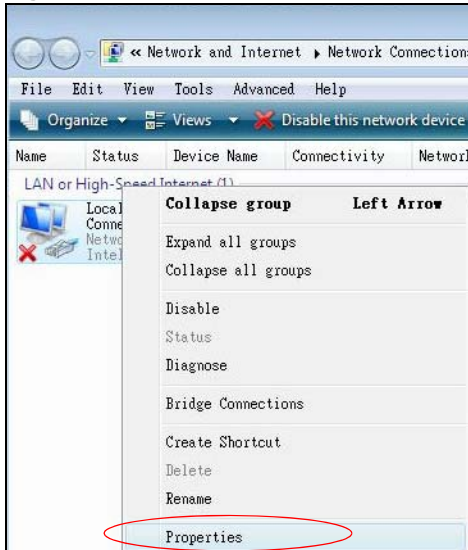

- 6 Select **Internet Protocol Version 4 (TCP/IPv4)** and click **Properties**.

Figure 146 Windows Vista: Local Area Connection Properties

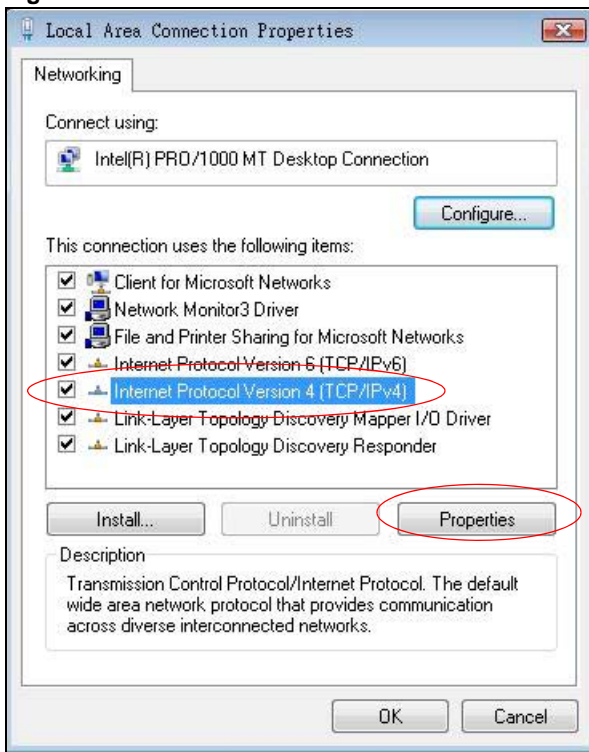

- 7 The **Internet Protocol Version 4 (TCP/IPv4) Properties** window opens (the **General** tab).
 - If you have a dynamic IP address click **Obtain an IP address automatically**.

- If you have a static IP address click **Use the following IP address** and fill in the **IP address**, **Subnet mask**, and **Default gateway** fields.
- Click **Advanced**.

Figure 147 Windows Vista: Internet Protocol Version 4 (TCP/IPv4) Properties

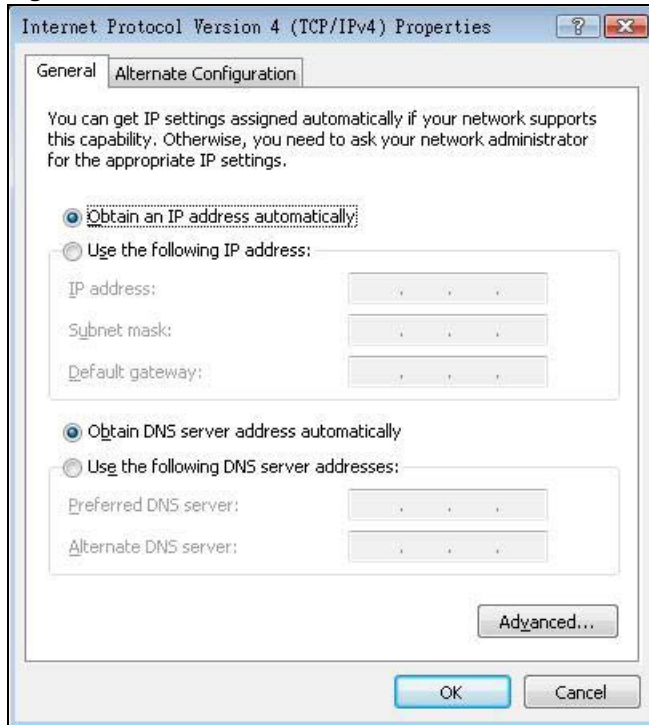

- 8 If you do not know your gateway's IP address, remove any previously installed gateways in the **IP Settings** tab and click **OK**.

Do one or more of the following if you want to configure additional IP addresses:

- In the **IP Settings** tab, in IP addresses, click **Add**.
- In **TCP/IP Address**, type an IP address in **IP address** and a subnet mask in **Subnet mask**, and then click **Add**.
- Repeat the above two steps for each IP address you want to add.
- Configure additional default gateways in the **IP Settings** tab by clicking **Add** in **Default gateways**.
- In **TCP/IP Gateway Address**, type the IP address of the default gateway in **Gateway**. To manually configure a default metric (the number of transmission hops), clear the **Automatic metric** check box and type a metric in **Metric**.
- Click **Add**.
- Repeat the previous three steps for each default gateway you want to add.
- Click **OK** when finished.

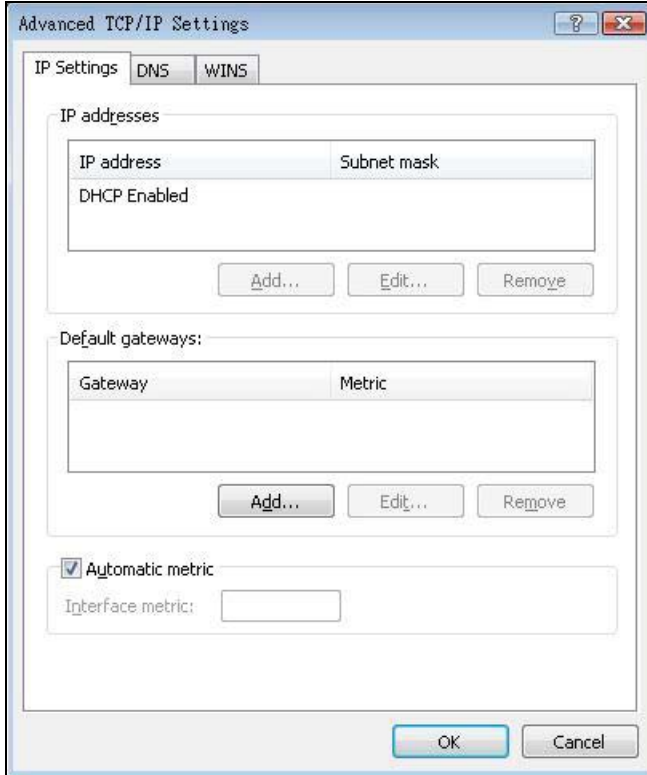
Figure 148 Windows Vista: Advanced TCP/IP Properties

- 9 In the **Internet Protocol Version 4 (TCP/IPv4) Properties** window, (the **General** tab):
- Click **Obtain DNS server address automatically** if you do not know your DNS server IP address(es).
 - If you know your DNS server IP address(es), click **Use the following DNS server addresses**, and type them in the **Preferred DNS server** and **Alternate DNS server** fields. If you have previously configured DNS servers, click **Advanced** and then the **DNS** tab to order them.

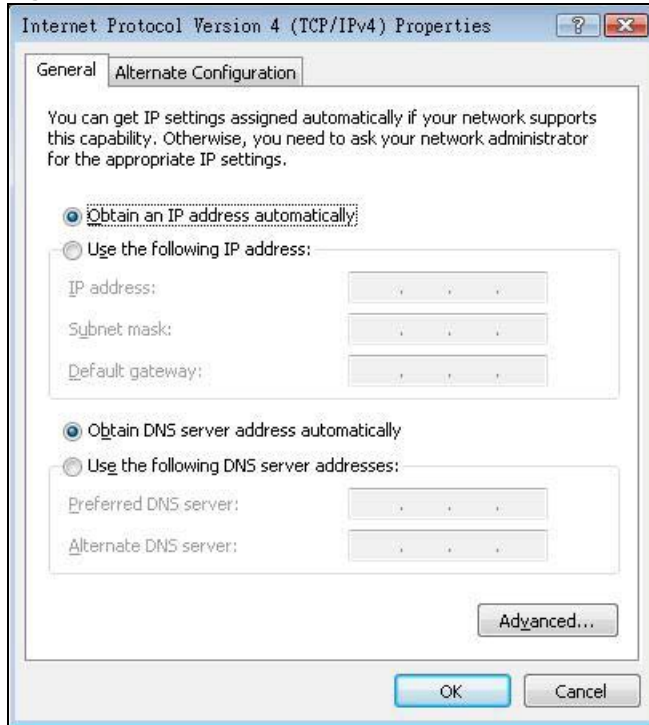
Figure 149 Windows Vista: Internet Protocol Version 4 (TCP/IPv4) Properties

- 10 Click **OK** to close the **Internet Protocol Version 4 (TCP/IPv4) Properties** window.
- 11 Click **Close** to close the **Local Area Connection Properties** window.
- 12 Close the **Network Connections** window.
- 13 Turn on your AMG1312-T Series and restart your computer (if prompted).

Verifying Settings

- 1 Click **Start**, **All Programs**, **Accessories** and then **Command Prompt**.
- 2 In the **Command Prompt** window, type "ipconfig" and then press [ENTER]. You can also open **Network Connections**, right-click a network connection, click **Status** and then click the **Support** tab.

Macintosh OS 8/9

- 1 Click the **Apple** menu, **Control Panel** and double-click **TCP/IP** to open the **TCP/IP Control Panel**.

Figure 150 Macintosh OS 8/9: Apple Menu

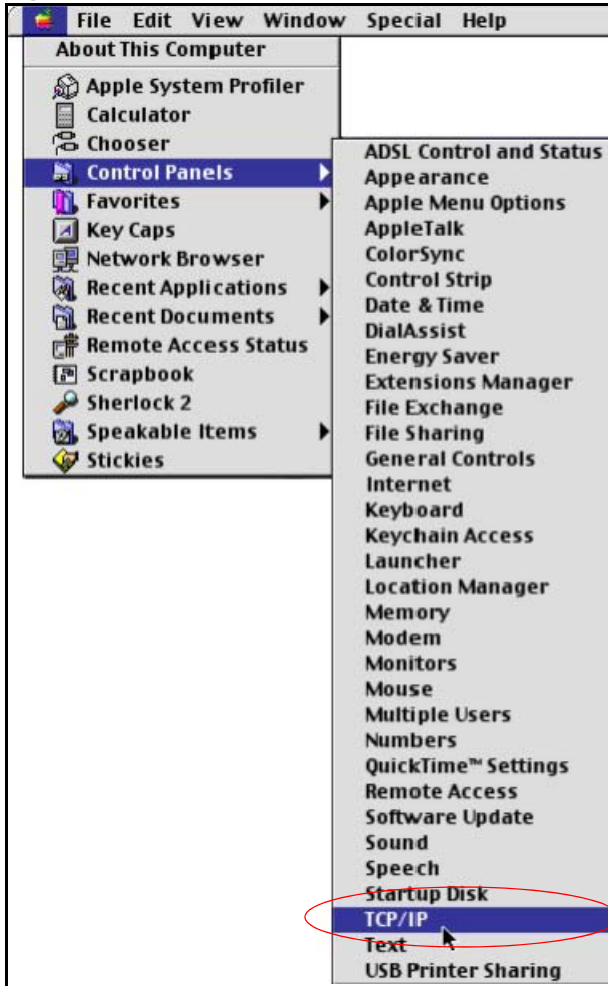

- 2 Select **Ethernet built-in** from the **Connect via** list.

Figure 151 Macintosh OS 8/9: TCP/IP

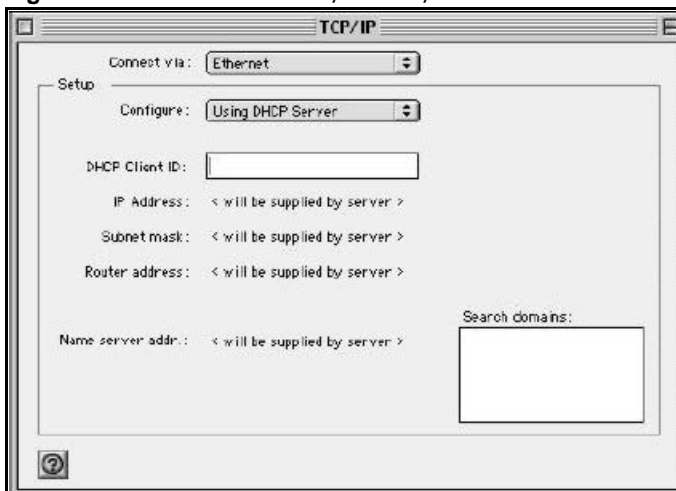

- 3 For dynamically assigned settings, select **Using DHCP Server** from the **Configure:** list.
- 4 For statically assigned settings, do the following:

- From the **Configure** box, select **Manually**.
 - Type your IP address in the **IP Address** box.
 - Type your subnet mask in the **Subnet mask** box.
 - Type the IP address of your AMG1312-T Series in the **Router address** box.
- 5 Close the **TCP/IP Control Panel**.
 - 6 Click **Save** if prompted, to save changes to your configuration.
 - 7 Turn on your AMG1312-T Series and restart your computer (if prompted).

Verifying Settings

Check your TCP/IP properties in the **TCP/IP Control Panel** window.

Macintosh OS X

- 1 Click the **Apple** menu, and click **System Preferences** to open the **System Preferences** window.

Figure 152 Macintosh OS X: Apple Menu

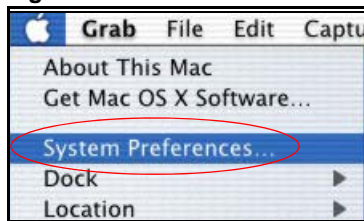

- 2 Click **Network** in the icon bar.
 - Select **Automatic** from the **Location** list.
 - Select **Built-in Ethernet** from the **Show** list.
 - Click the **TCP/IP** tab.
- 3 For dynamically assigned settings, select **Using DHCP** from the **Configure** list.

Figure 153 Macintosh OS X: Network

- 4 For statically assigned settings, do the following:
 - From the **Configure** box, select **Manually**.
 - Type your IP address in the **IP Address** box.
 - Type your subnet mask in the **Subnet mask** box.
 - Type the IP address of your AMG1312-T Series in the **Router address** box.
- 5 Click **Apply Now** and close the window.
- 6 Turn on your AMG1312-T Series and restart your computer (if prompted).

Verifying Settings

Check your TCP/IP properties in the **Network** window.

Linux

This section shows you how to configure your computer's TCP/IP settings in Red Hat Linux 9.0. Procedure, screens and file location may vary depending on your Linux distribution and release version.

Note: Make sure you are logged in as the root administrator.

Using the K Desktop Environment (KDE)

Follow the steps below to configure your computer IP address using the KDE.

- 1 Click the Red Hat button (located on the bottom left corner), select **System Setting** and click **Network**.

Figure 154 Red Hat 9.0: KDE: Network Configuration: Devices

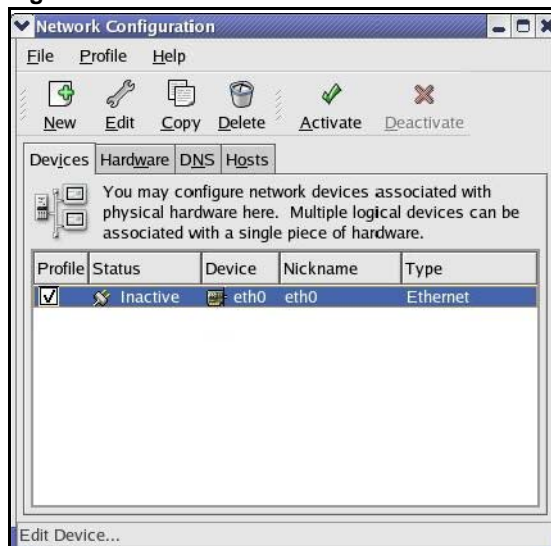

- 2 Double-click on the profile of the network card you wish to configure. The **Ethernet Device General** screen displays as shown.

Figure 155 Red Hat 9.0: KDE: Ethernet Device: General



- If you have a dynamic IP address, click **Automatically obtain IP address settings with** and select **dhcp** from the drop down list.
- If you have a static IP address, click **Statically set IP Addresses** and fill in the **Address**, **Subnet mask**, and **Default Gateway Address** fields.

- 3 Click **OK** to save the changes and close the **Ethernet Device General** screen.

- 4 If you know your DNS server IP address(es), click the **DNS** tab in the **Network Configuration** screen. Enter the DNS server information in the fields provided.

Figure 156 Red Hat 9.0: KDE: Network Configuration: DNS

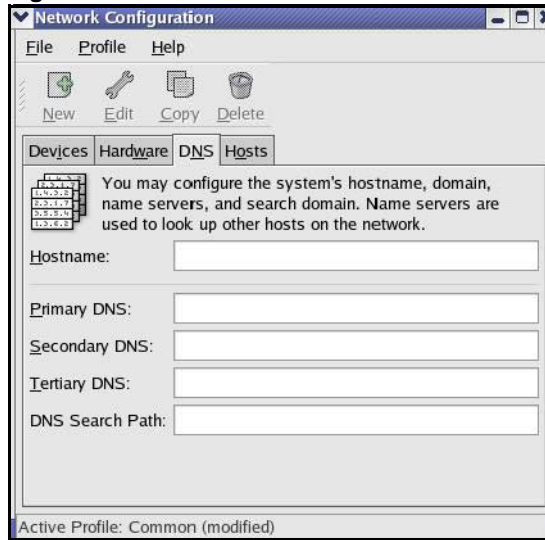

- 5 Click the **Devices** tab.
- 6 Click the **Activate** button to apply the changes. The following screen displays. Click **Yes to save the changes in all screens**.

Figure 157 Red Hat 9.0: KDE: Network Configuration: Activate



- 7 After the network card restart process is complete, make sure the **Status** is **Active** in the **Network Configuration** screen.

Using Configuration Files

Follow the steps below to edit the network configuration files and set your computer IP address.

- 1 Assuming that you have only one network card on the computer, locate the `ifconfig-eth0` configuration file (where `eth0` is the name of the Ethernet card). Open the configuration file with any plain text editor.
 - If you have a dynamic IP address, enter `dhcp` in the `BOOTPROTO=` field. The following figure shows an example.

Figure 158 Red Hat 9.0: Dynamic IP Address Setting in ifconfig-eth0

```

DEVICE=eth0
ONBOOT=yes
BOOTPROTO=dhcp
USERCTL=no
PEERDNS=yes
TYPE=Ethernet

```

- If you have a static IP address, enter **static** in the `BOOTPROTO=` field. Type `IPADDR=` followed by the IP address (in dotted decimal notation) and type `NETMASK=` followed by the subnet mask. The following example shows an example where the static IP address is 192.168.1.10 and the subnet mask is 255.255.255.0.

Figure 159 Red Hat 9.0: Static IP Address Setting in ifconfig-eth0

```

DEVICE=eth0
ONBOOT=yes
BOOTPROTO=static
IPADDR=192.168.1.10
NETMASK=255.255.255.0
USERCTL=no
PEERDNS=yes
TYPE=Ethernet

```

- 2 If you know your DNS server IP address(es), enter the DNS server information in the `resolv.conf` file in the `/etc` directory. The following figure shows an example where two DNS server IP addresses are specified.

Figure 160 Red Hat 9.0: DNS Settings in resolv.conf

```

nameserver 172.23.5.1
nameserver 172.23.5.2

```

- 3 After you edit and save the configuration files, you must restart the network card. Enter `./network restart` in the `/etc/rc.d/init.d` directory. The following figure shows an example.

Figure 161 Red Hat 9.0: Restart Ethernet Card

```

[root@localhost init.d]# network restart

Shutting down interface eth0:           [OK]
Shutting down loopback interface:       [OK]
Setting network parameters:             [OK]
Bringing up loopback interface:         [OK]
Bringing up interface eth0:             [OK]

```

Verifying Settings

Enter `ifconfig` in a terminal screen to check your TCP/IP properties.

Figure 162 Red Hat 9.0: Checking TCP/IP Properties

```
[root@localhost]# ifconfig
eth0      Link encap:Ethernet  HWaddr 00:50:BA:72:5B:44
          inet addr:172.23.19.129  Bcast:172.23.19.255  Mask:255.255.255.0
          UP BROADCAST RUNNING MULTICAST  MTU:1500  Metric:1
          RX packets:717 errors:0 dropped:0 overruns:0 frame:0
          TX packets:13 errors:0 dropped:0 overruns:0 carrier:0
          collisions:0 txqueuelen:100
          RX bytes:730412 (713.2 Kb)  TX bytes:1570 (1.5 Kb)
          Interrupt:10 Base address:0x1000
[root@localhost]#
```

IP Addresses and Subnetting

This appendix introduces IP addresses and subnet masks.

IP addresses identify individual devices on a network. Every networking device (including computers, servers, routers, printers, etc.) needs an IP address to communicate across the network. These networking devices are also known as hosts.

Subnet masks determine the maximum number of possible hosts on a network. You can also use subnet masks to divide one network into multiple sub-networks.

Introduction to IP Addresses

One part of the IP address is the network number, and the other part is the host ID. In the same way that houses on a street share a common street name, the hosts on a network share a common network number. Similarly, as each house has its own house number, each host on the network has its own unique identifying number - the host ID. Routers use the network number to send packets to the correct network, while the host ID determines to which host on the network the packets are delivered.

Structure

An IP address is made up of four parts, written in dotted decimal notation (for example, 192.168.1.1). Each of these four parts is known as an octet. An octet is an eight-digit binary number (for example 11000000, which is 192 in decimal notation).

Therefore, each octet has a possible range of 00000000 to 11111111 in binary, or 0 to 255 in decimal.

The following figure shows an example IP address in which the first three octets (192.168.1) are the network number, and the fourth octet (16) is the host ID.

Figure 163 Network Number and Host ID

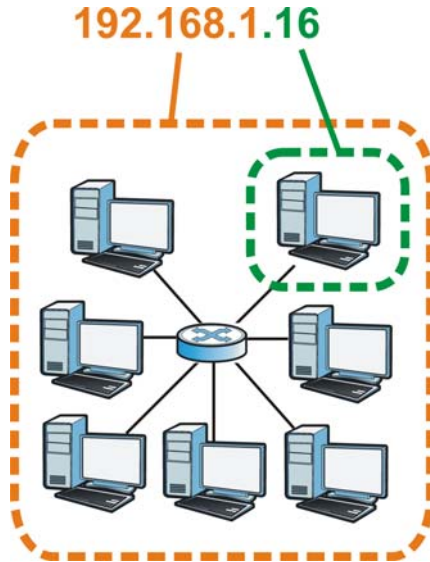

How much of the IP address is the network number and how much is the host ID varies according to the subnet mask.

Subnet Masks

A subnet mask is used to determine which bits are part of the network number, and which bits are part of the host ID (using a logical AND operation). The term “subnet” is short for “sub-network”.

A subnet mask has 32 bits. If a bit in the subnet mask is a “1” then the corresponding bit in the IP address is part of the network number. If a bit in the subnet mask is “0” then the corresponding bit in the IP address is part of the host ID.

The following example shows a subnet mask identifying the network number (in bold text) and host ID of an IP address (192.168.1.2 in decimal).

Table 98 Subnet Masks

	1ST OCTET: (192)	2ND OCTET: (168)	3RD OCTET: (1)	4TH OCTET (2)
IP Address (Binary)	11000000	10101000	00000001	00000010
Subnet Mask (Binary)	11111111	11111111	11111111	00000000
Network Number	11000000	10101000	00000001	
Host ID				00000010

By convention, subnet masks always consist of a continuous sequence of ones beginning from the leftmost bit of the mask, followed by a continuous sequence of zeros, for a total number of 32 bits.

Subnet masks can be referred to by the size of the network number part (the bits with a “1” value). For example, an “8-bit mask” means that the first 8 bits of the mask are ones and the remaining 24 bits are zeroes.

Subnet masks are expressed in dotted decimal notation just like IP addresses. The following examples show the binary and decimal notation for 8-bit, 16-bit, 24-bit and 29-bit subnet masks.

Table 99 Subnet Masks

	BINARY				DECIMAL
	1ST OCTET	2ND OCTET	3RD OCTET	4TH OCTET	
8-bit mask	11111111	00000000	00000000	00000000	255.0.0.0
16-bit mask	11111111	11111111	00000000	00000000	255.255.0.0
24-bit mask	11111111	11111111	11111111	00000000	255.255.255.0
29-bit mask	11111111	11111111	11111111	11111000	255.255.255.248

Network Size

The size of the network number determines the maximum number of possible hosts you can have on your network. The larger the number of network number bits, the smaller the number of remaining host ID bits.

An IP address with host IDs of all zeros is the IP address of the network (192.168.1.0 with a 24-bit subnet mask, for example). An IP address with host IDs of all ones is the broadcast address for that network (192.168.1.255 with a 24-bit subnet mask, for example).

As these two IP addresses cannot be used for individual hosts, calculate the maximum number of possible hosts in a network as follows:

Table 100 Maximum Host Numbers

SUBNET MASK		HOST ID SIZE		MAXIMUM NUMBER OF HOSTS
8 bits	255.0.0.0	24 bits	$2^{24} - 2$	16777214
16 bits	255.255.0.0	16 bits	$2^{16} - 2$	65534
24 bits	255.255.255.0	8 bits	$2^8 - 2$	254
29 bits	255.255.255.248	3 bits	$2^3 - 2$	6

Notation

Since the mask is always a continuous number of ones beginning from the left, followed by a continuous number of zeros for the remainder of the 32 bit mask, you can simply specify the number of ones instead of writing the value of each octet. This is usually specified by writing a "/" followed by the number of bits in the mask after the address.

For example, 192.1.1.0 /25 is equivalent to saying 192.1.1.0 with subnet mask 255.255.255.128.

The following table shows some possible subnet masks using both notations.

Table 101 Alternative Subnet Mask Notation

SUBNET MASK	ALTERNATIVE NOTATION	LAST OCTET (BINARY)	LAST OCTET (DECIMAL)
255.255.255.0	/24	0000 0000	0
255.255.255.128	/25	1000 0000	128
255.255.255.192	/26	1100 0000	192

Table 101 Alternative Subnet Mask Notation (continued)

SUBNET MASK	ALTERNATIVE NOTATION	LAST OCTET (BINARY)	LAST OCTET (DECIMAL)
255.255.255.224	/27	1110 0000	224
255.255.255.240	/28	1111 0000	240
255.255.255.248	/29	1111 1000	248
255.255.255.252	/30	1111 1100	252

Subnetting

You can use subnetting to divide one network into multiple sub-networks. In the following example a network administrator creates two sub-networks to isolate a group of servers from the rest of the company network for security reasons.

In this example, the company network address is 192.168.1.0. The first three octets of the address (192.168.1) are the network number, and the remaining octet is the host ID, allowing a maximum of $2^8 - 2$ or 254 possible hosts.

The following figure shows the company network before subnetting.

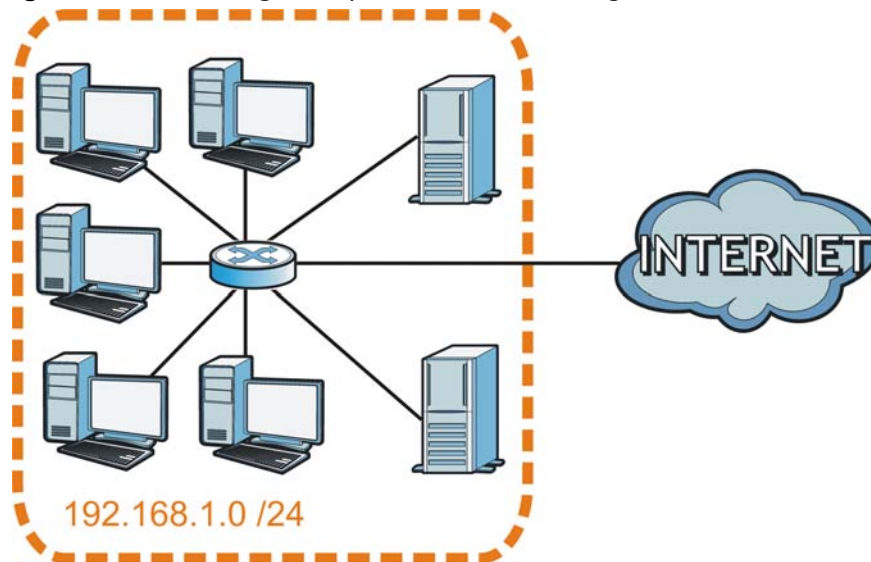
Figure 164 Subnetting Example: Before Subnetting

You can “borrow” one of the host ID bits to divide the network 192.168.1.0 into two separate sub-networks. The subnet mask is now 25 bits (255.255.255.128 or /25).

The “borrowed” host ID bit can have a value of either 0 or 1, allowing two subnets; 192.168.1.0 /25 and 192.168.1.128 /25.

The following figure shows the company network after subnetting. There are now two sub-networks, **A** and **B**.

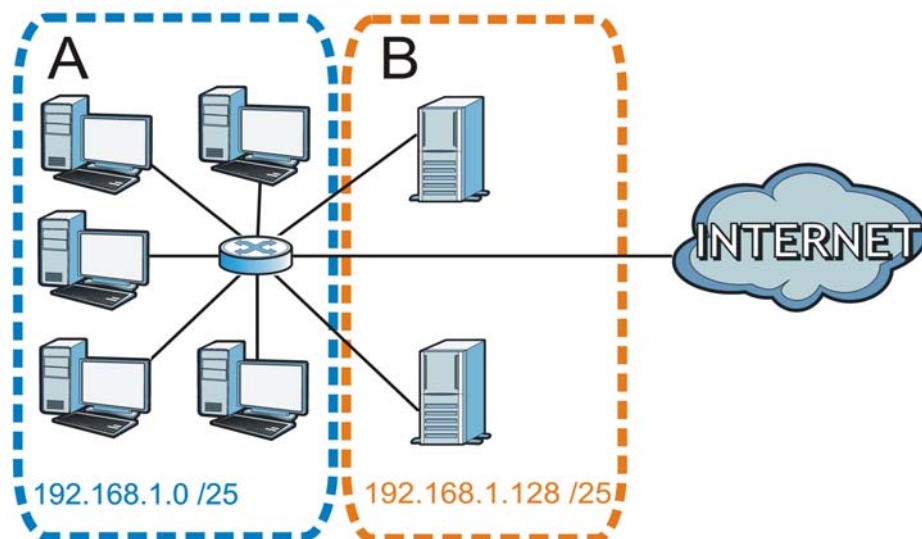
Figure 165 Subnetting Example: After Subnetting

In a 25-bit subnet the host ID has 7 bits, so each sub-network has a maximum of $2^7 - 2$ or 126 possible hosts (a host ID of all zeroes is the subnet's address itself, all ones is the subnet's broadcast address).

192.168.1.0 with mask 255.255.255.128 is subnet **A** itself, and 192.168.1.127 with mask 255.255.255.128 is its broadcast address. Therefore, the lowest IP address that can be assigned to an actual host for subnet **A** is 192.168.1.1 and the highest is 192.168.1.126.

Similarly, the host ID range for subnet **B** is 192.168.1.129 to 192.168.1.254.

Example: Four Subnets

The previous example illustrated using a 25-bit subnet mask to divide a 24-bit address into two subnets. Similarly, to divide a 24-bit address into four subnets, you need to "borrow" two host ID bits to give four possible combinations (00, 01, 10 and 11). The subnet mask is 26 bits (11111111.11111111.11111111.11000000) or 255.255.255.192.

Each subnet contains 6 host ID bits, giving $2^6 - 2$ or 62 hosts for each subnet (a host ID of all zeroes is the subnet itself, all ones is the subnet's broadcast address).

Table 102 Subnet 1

IP/SUBNET MASK	NETWORK NUMBER	LAST OCTET BIT VALUE
IP Address (Decimal)	192.168.1.	0
IP Address (Binary)	11000000.10101000.00000001.	00000000
Subnet Mask (Binary)	11111111.11111111.11111111.	11000000
Subnet Address: 192.168.1.0	Lowest Host ID: 192.168.1.1	
Broadcast Address: 192.168.1.63	Highest Host ID: 192.168.1.62	

Table 103 Subnet 2

IP/SUBNET MASK	NETWORK NUMBER	LAST OCTET BIT VALUE
IP Address	192.168.1.	64
IP Address (Binary)	11000000.10101000.00000001.	01000000
Subnet Mask (Binary)	11111111.11111111.11111111.	11000000
Subnet Address: 192.168.1.64	Lowest Host ID: 192.168.1.65	
Broadcast Address: 192.168.1.127	Highest Host ID: 192.168.1.126	

Table 104 Subnet 3

IP/SUBNET MASK	NETWORK NUMBER	LAST OCTET BIT VALUE
IP Address	192.168.1.	128
IP Address (Binary)	11000000.10101000.00000001.	10000000
Subnet Mask (Binary)	11111111.11111111.11111111.	11000000
Subnet Address: 192.168.1.128	Lowest Host ID: 192.168.1.129	
Broadcast Address: 192.168.1.191	Highest Host ID: 192.168.1.190	

Table 105 Subnet 4

IP/SUBNET MASK	NETWORK NUMBER	LAST OCTET BIT VALUE
IP Address	192.168.1.	192
IP Address (Binary)	11000000.10101000.00000001.	11000000
Subnet Mask (Binary)	11111111.11111111.11111111.	11000000
Subnet Address: 192.168.1.192	Lowest Host ID: 192.168.1.193	
Broadcast Address: 192.168.1.255	Highest Host ID: 192.168.1.254	

Example: Eight Subnets

Similarly, use a 27-bit mask to create eight subnets (000, 001, 010, 011, 100, 101, 110 and 111).

The following table shows IP address last octet values for each subnet.

Table 106 Eight Subnets

SUBNET	SUBNET ADDRESS	FIRST ADDRESS	LAST ADDRESS	BROADCAST ADDRESS
1	0	1	30	31
2	32	33	62	63
3	64	65	94	95
4	96	97	126	127
5	128	129	158	159
6	160	161	190	191
7	192	193	222	223
8	224	225	254	255

Subnet Planning

The following table is a summary for subnet planning on a network with a 24-bit network number.

Table 107 24-bit Network Number Subnet Planning

NO. "BORROWED" HOST BITS	SUBNET MASK	NO. SUBNETS	NO. HOSTS PER SUBNET
1	255.255.255.128 (/25)	2	126
2	255.255.255.192 (/26)	4	62
3	255.255.255.224 (/27)	8	30
4	255.255.255.240 (/28)	16	14
5	255.255.255.248 (/29)	32	6
6	255.255.255.252 (/30)	64	2
7	255.255.255.254 (/31)	128	1

The following table is a summary for subnet planning on a network with a 16-bit network number.

Table 108 16-bit Network Number Subnet Planning

NO. "BORROWED" HOST BITS	SUBNET MASK	NO. SUBNETS	NO. HOSTS PER SUBNET
1	255.255.128.0 (/17)	2	32766
2	255.255.192.0 (/18)	4	16382
3	255.255.224.0 (/19)	8	8190
4	255.255.240.0 (/20)	16	4094
5	255.255.248.0 (/21)	32	2046
6	255.255.252.0 (/22)	64	1022
7	255.255.254.0 (/23)	128	510
8	255.255.255.0 (/24)	256	254
9	255.255.255.128 (/25)	512	126
10	255.255.255.192 (/26)	1024	62
11	255.255.255.224 (/27)	2048	30
12	255.255.255.240 (/28)	4096	14
13	255.255.255.248 (/29)	8192	6
14	255.255.255.252 (/30)	16384	2
15	255.255.255.254 (/31)	32768	1

Configuring IP Addresses

Where you obtain your network number depends on your particular situation. If the ISP or your network administrator assigns you a block of registered IP addresses, follow their instructions in selecting the IP addresses and the subnet mask.

If the ISP did not explicitly give you an IP network number, then most likely you have a single user account and the ISP will assign you a dynamic IP address when the connection is established. If this is the case, it is recommended that you select a network number from 192.168.0.0 to 192.168.255.0. The Internet Assigned Number Authority (IANA) reserved this block of addresses specifically for private use; please do not use any other number unless you are told otherwise. You must also enable Network Address Translation (NAT) on the AMG1312-T Series.

Once you have decided on the network number, pick an IP address for your AMG1312-T Series that is easy to remember (for instance, 192.168.1.1) but make sure that no other device on your network is using that IP address.

The subnet mask specifies the network number portion of an IP address. Your AMG1312-T Series will compute the subnet mask automatically based on the IP address that you entered. You don't need to change the subnet mask computed by the AMG1312-T Series unless you are instructed to do otherwise.

Private IP Addresses

Every machine on the Internet must have a unique address. If your networks are isolated from the Internet (running only between two branch offices, for example) you can assign any IP addresses to the hosts without problems. However, the Internet Assigned Numbers Authority (IANA) has reserved the following three blocks of IP addresses specifically for private networks:

- 10.0.0.0 — 10.255.255.255
- 172.16.0.0 — 172.31.255.255
- 192.168.0.0 — 192.168.255.255

You can obtain your IP address from the IANA, from an ISP, or it can be assigned from a private network. If you belong to a small organization and your Internet access is through an ISP, the ISP can provide you with the Internet addresses for your local networks. On the other hand, if you are part of a much larger organization, you should consult your network administrator for the appropriate IP addresses.

Regardless of your particular situation, do not create an arbitrary IP address; always follow the guidelines above. For more information on address assignment, please refer to RFC 1597, *Address Allocation for Private Internets* and RFC 1466, *Guidelines for Management of IP Address Space*.

Pop-up Windows, JavaScripts and Java Permissions

In order to use the web configurator you need to allow:

- Web browser pop-up windows from your device.
- JavaScripts (enabled by default).
- Java permissions (enabled by default).

Note: Internet Explorer 6 screens are used here. Screens for other Internet Explorer versions may vary.

Internet Explorer Pop-up Blockers

You may have to disable pop-up blocking to log into your device.

Either disable pop-up blocking (enabled by default in Windows XP SP (Service Pack) 2) or allow pop-up blocking and create an exception for your device's IP address.

Disable Pop-up Blockers

- 1 In Internet Explorer, select **Tools, Pop-up Blocker** and then select **Turn Off Pop-up Blocker**.

Figure 166 Pop-up Blocker

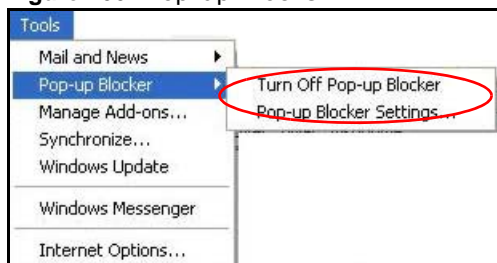

You can also check if pop-up blocking is disabled in the **Pop-up Blocker** section in the **Privacy** tab.

- 1 In Internet Explorer, select **Tools, Internet Options, Privacy**.
- 2 Clear the **Block pop-ups** check box in the **Pop-up Blocker** section of the screen. This disables any web pop-up blockers you may have enabled.

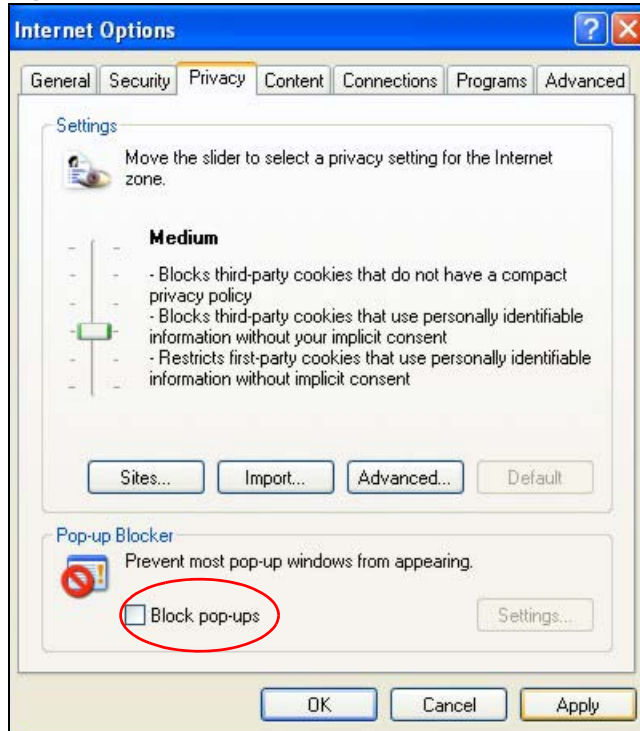
Figure 167 Internet Options: Privacy

- 3 Click **Apply** to save this setting.

Enable Pop-up Blockers with Exceptions

Alternatively, if you only want to allow pop-up windows from your device, see the following steps.

- 1 In Internet Explorer, select **Tools, Internet Options** and then the **Privacy** tab.
- 2 Select **Settings...** to open the **Pop-up Blocker Settings** screen.

Figure 168 Internet Options: Privacy

- 3 Type the IP address of your device (the web page that you do not want to have blocked) with the prefix "http://". For example, http://192.168.167.1.
- 4 Click **Add** to move the IP address to the list of **Allowed sites**.

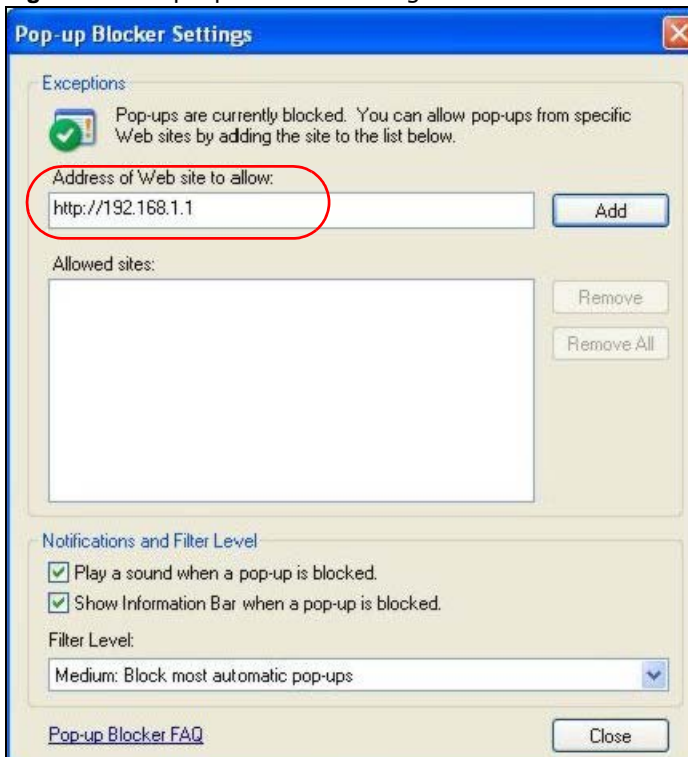
Figure 169 Pop-up Blocker Settings

- 5 Click **Close** to return to the **Privacy** screen.
- 6 Click **Apply** to save this setting.

JavaScripts

If pages of the web configurator do not display properly in Internet Explorer, check that JavaScripts are allowed.

- 1 In Internet Explorer, click **Tools**, **Internet Options** and then the **Security** tab.

Figure 170 Internet Options: Security

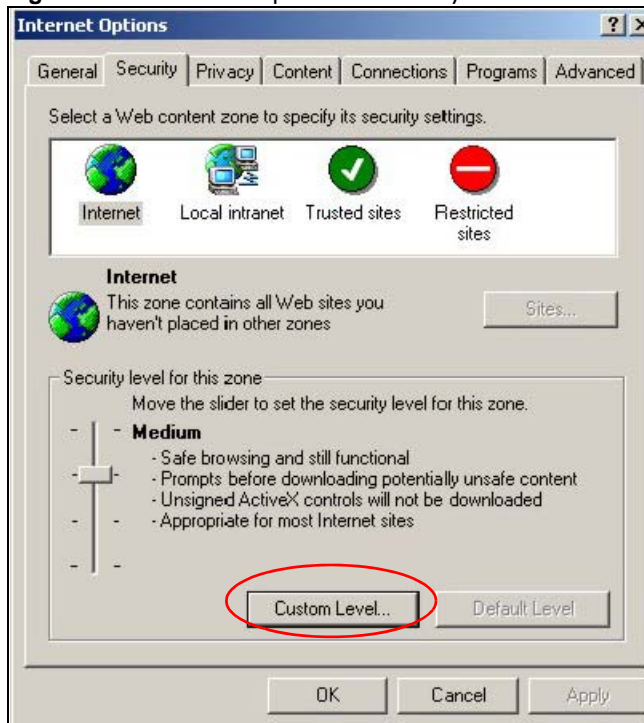

- 2 Click the **Custom Level...** button.
- 3 Scroll down to **Scripting**.
- 4 Under **Active scripting** make sure that **Enable** is selected (the default).
- 5 Under **Scripting of Java applets** make sure that **Enable** is selected (the default).
- 6 Click **OK** to close the window.

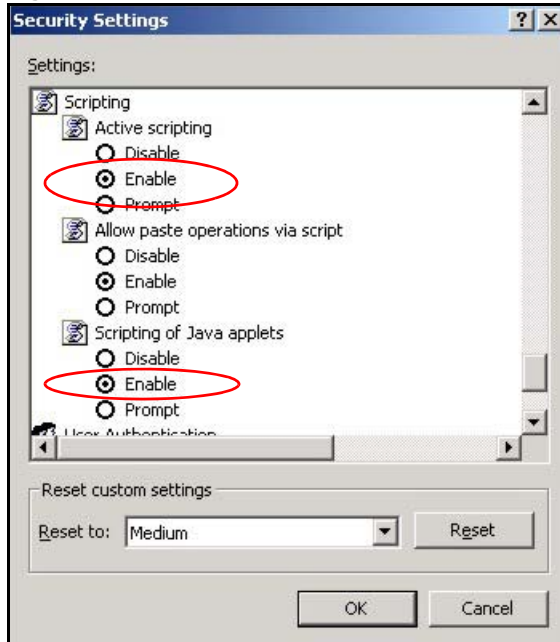
Figure 171 Security Settings - Java Scripting

Java Permissions

- 1 From Internet Explorer, click **Tools, Internet Options** and then the **Security** tab.
- 2 Click the **Custom Level...** button.
- 3 Scroll down to **Microsoft VM**.
- 4 Under **Java permissions** make sure that a safety level is selected.
- 5 Click **OK** to close the window.

Figure 172 Security Settings - Java

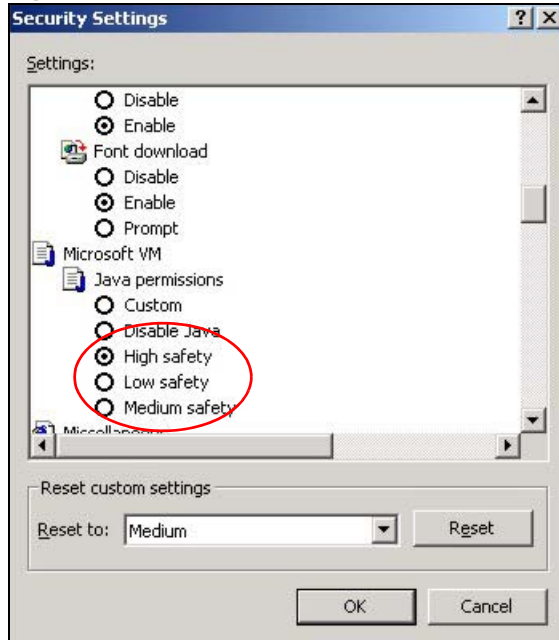

JAVA (Sun)

- 1 From Internet Explorer, click **Tools, Internet Options** and then the **Advanced** tab.
- 2 Make sure that **Use Java 2 for <applet>** under **Java (Sun)** is selected.
- 3 Click **OK** to close the window.

Figure 173 Java (Sun)

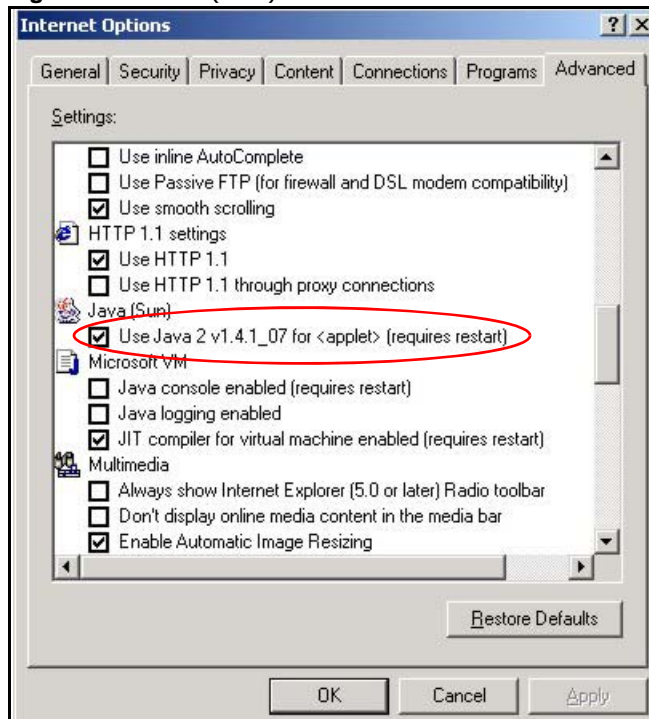

Mozilla Firefox

Mozilla Firefox 2.0 screens are used here. Screens for other versions may vary.

You can enable Java, Javascripts and pop-ups in one screen. Click **Tools**, then click **Options** in the screen that appears.

Figure 174 Mozilla Firefox: Tools > Options

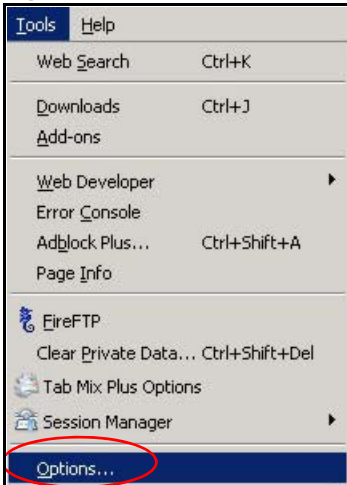

Click **Content** to show the screen below. Select the check boxes as shown in the following screen.

Figure 175 Mozilla Firefox Content Security

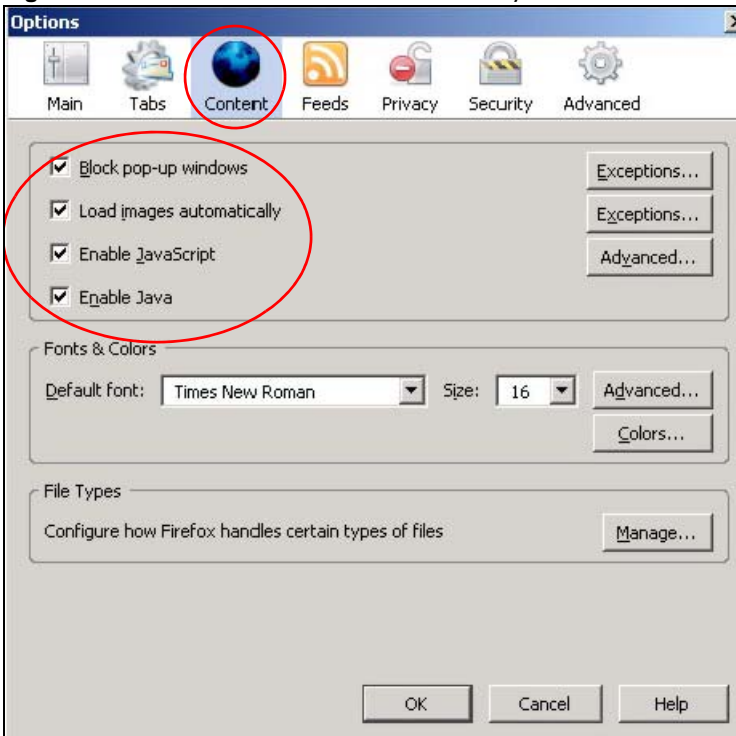

Wireless LANs

Wireless LAN Topologies

This section discusses ad-hoc and infrastructure wireless LAN topologies.

Ad-hoc Wireless LAN Configuration

The simplest WLAN configuration is an independent (Ad-hoc) WLAN that connects a set of computers with wireless adapters (A, B, C). Any time two or more wireless adapters are within range of each other, they can set up an independent network, which is commonly referred to as an ad-hoc network or Independent Basic Service Set (IBSS). The following diagram shows an example of notebook computers using wireless adapters to form an ad-hoc wireless LAN.

Figure 176 Peer-to-Peer Communication in an Ad-hoc Network

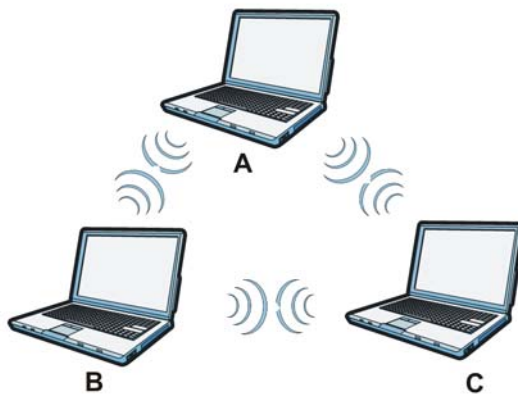

BSS

A Basic Service Set (BSS) exists when all communications between wireless clients or between a wireless client and a wired network client go through one access point (AP).

Intra-BSS traffic is traffic between wireless clients in the BSS. When Intra-BSS is enabled, wireless client **A** and **B** can access the wired network and communicate with each other. When Intra-BSS is disabled, wireless client **A** and **B** can still access the wired network but cannot communicate with each other.

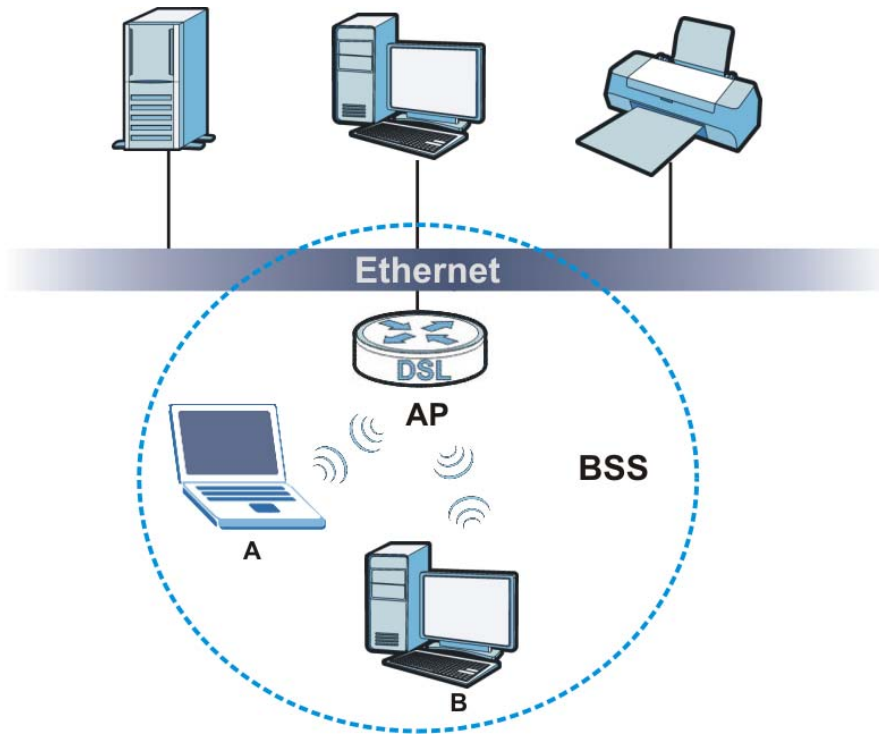
Figure 177 Basic Service Set

ESS

An Extended Service Set (ESS) consists of a series of overlapping BSSs, each containing an access point, with each access point connected together by a wired network. This wired connection between APs is called a Distribution System (DS).

This type of wireless LAN topology is called an Infrastructure WLAN. The Access Points not only provide communication with the wired network but also mediate wireless network traffic in the immediate neighborhood.

An ESSID (ESS IDentification) uniquely identifies each ESS. All access points and their associated wireless clients within the same ESS must have the same ESSID in order to communicate.

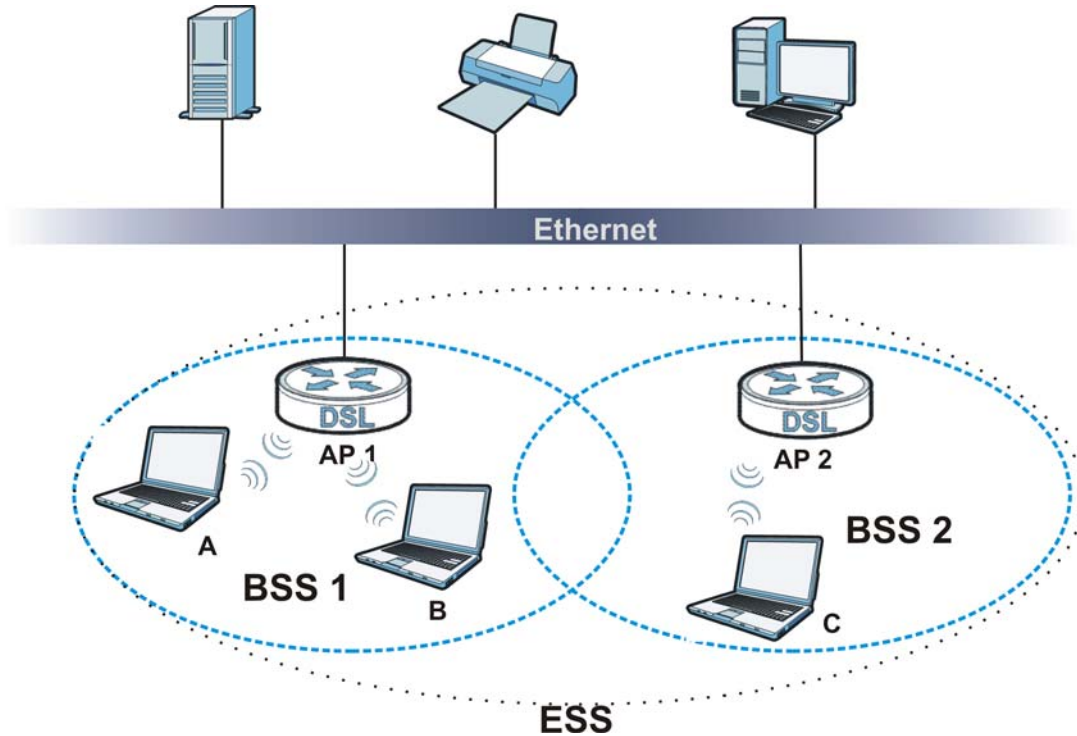
Figure 178 Infrastructure WLAN

Channel

A channel is the radio frequency(ies) used by wireless devices to transmit and receive data. Channels available depend on your geographical area. You may have a choice of channels (for your region) so you should use a channel different from an adjacent AP (access point) to reduce interference. Interference occurs when radio signals from different access points overlap causing interference and degrading performance.

Adjacent channels partially overlap however. To avoid interference due to overlap, your AP should be on a channel at least five channels away from a channel that an adjacent AP is using. For example, if your region has 11 channels and an adjacent AP is using channel 1, then you need to select a channel between 6 or 11.

RTS/CTS

A hidden node occurs when two stations are within range of the same access point, but are not within range of each other. The following figure illustrates a hidden node. Both stations (STA) are within range of the access point (AP) or wireless gateway, but out-of-range of each other, so they cannot "hear" each other, that is they do not know if the channel is currently being used. Therefore, they are considered hidden from each other.

Figure 179 RTS/CTS

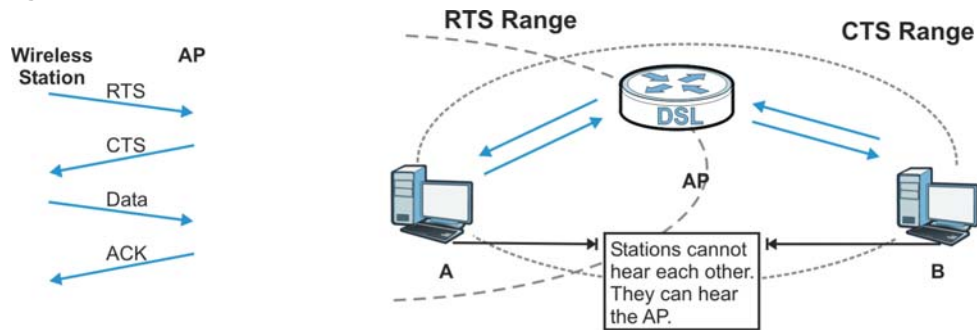

When station **A** sends data to the AP, it might not know that the station **B** is already using the channel. If these two stations send data at the same time, collisions may occur when both sets of data arrive at the AP at the same time, resulting in a loss of messages for both stations.

RTS/CTS is designed to prevent collisions due to hidden nodes. An **RTS/CTS** defines the biggest size data frame you can send before an RTS (Request To Send)/CTS (Clear to Send) handshake is invoked.

When a data frame exceeds the **RTS/CTS** value you set (between 0 to 2432 bytes), the station that wants to transmit this frame must first send an RTS (Request To Send) message to the AP for permission to send it. The AP then responds with a CTS (Clear to Send) message to all other stations within its range to notify them to defer their transmission. It also reserves and confirms with the requesting station the time frame for the requested transmission.

Stations can send frames smaller than the specified **RTS/CTS** directly to the AP without the RTS (Request To Send)/CTS (Clear to Send) handshake.

You should only configure **RTS/CTS** if the possibility of hidden nodes exists on your network and the "cost" of resending large frames is more than the extra network overhead involved in the RTS (Request To Send)/CTS (Clear to Send) handshake.

If the **RTS/CTS** value is greater than the **Fragmentation Threshold** value (see next), then the RTS (Request To Send)/CTS (Clear to Send) handshake will never occur as data frames will be fragmented before they reach **RTS/CTS** size.

Note: Enabling the RTS Threshold causes redundant network overhead that could negatively affect the throughput performance instead of providing a remedy.

Fragmentation Threshold

A **Fragmentation Threshold** is the maximum data fragment size (between 256 and 2432 bytes) that can be sent in the wireless network before the AP will fragment the packet into smaller data frames.

A large **Fragmentation Threshold** is recommended for networks not prone to interference while you should set a smaller threshold for busy networks or networks that are prone to interference.

If the **Fragmentation Threshold** value is smaller than the **RTS/CTS** value (see previously) you set then the RTS (Request To Send)/CTS (Clear to Send) handshake will never occur as data frames will be fragmented before they reach **RTS/CTS** size.

Preamble Type

Preamble is used to signal that data is coming to the receiver. Short and long refer to the length of the synchronization field in a packet.

Short preamble increases performance as less time sending preamble means more time for sending data. All IEEE 802.11 compliant wireless adapters support long preamble, but not all support short preamble.

Use long preamble if you are unsure what preamble mode other wireless devices on the network support, and to provide more reliable communications in busy wireless networks.

Use short preamble if you are sure all wireless devices on the network support it, and to provide more efficient communications.

Use the dynamic setting to automatically use short preamble when all wireless devices on the network support it, otherwise the AMG1312-T Series uses long preamble.

Note: The wireless devices **MUST** use the same preamble mode in order to communicate.

IEEE 802.11g Wireless LAN

IEEE 802.11g is fully compatible with the IEEE 802.11b standard. This means an IEEE 802.11b adapter can interface directly with an IEEE 802.11g access point (and vice versa) at 11 Mbps or lower depending on range. IEEE 802.11g has several intermediate rate steps between the maximum and minimum data rates. The IEEE 802.11g data rate and modulation are as follows:

Table 109 IEEE 802.11g

DATA RATE (MBPS)	MODULATION
1	DBPSK (Differential Binary Phase Shift Keyed)
2	DQPSK (Differential Quadrature Phase Shift Keying)
5.5 / 11	CCK (Complementary Code Keying)
6/9/12/18/24/36/48/ 54	OFDM (Orthogonal Frequency Division Multiplexing)

Wireless Security Overview

Wireless security is vital to your network to protect wireless communication between wireless clients, access points and the wired network.

Wireless security methods available on the AMG1312-T Series are data encryption, wireless client authentication, restricting access by device MAC address and hiding the AMG1312-T Series identity.

The following figure shows the relative effectiveness of these wireless security methods available on your AMG1312-T Series.

Table 110 Wireless Security Levels

SECURITY LEVEL	SECURITY TYPE
Least Secure	Unique SSID (Default)
	Unique SSID with Hide SSID Enabled
	MAC Address Filtering
	WEP Encryption
	IEEE802.1x EAP with RADIUS Server Authentication
	Wi-Fi Protected Access (WPA)
Most Secure	WPA2

Note: You must enable the same wireless security settings on the AMG1312-T Series and on all wireless clients that you want to associate with it.

IEEE 802.1x

In June 2001, the IEEE 802.1x standard was designed to extend the features of IEEE 802.11 to support extended authentication as well as providing additional accounting and control features. It is supported by Windows XP and a number of network devices. Some advantages of IEEE 802.1x are:

- User based identification that allows for roaming.
- Support for RADIUS (Remote Authentication Dial In User Service, RFC 2138, 2139) for centralized user profile and accounting management on a network RADIUS server.
- Support for EAP (Extensible Authentication Protocol, RFC 2486) that allows additional authentication methods to be deployed with no changes to the access point or the wireless clients.

RADIUS

RADIUS is based on a client-server model that supports authentication, authorization and accounting. The access point is the client and the server is the RADIUS server. The RADIUS server handles the following tasks:

- Authentication
Determines the identity of the users.
- Authorization
Determines the network services available to authenticated users once they are connected to the network.
- Accounting
Keeps track of the client's network activity.

RADIUS is a simple package exchange in which your AP acts as a message relay between the wireless client and the network RADIUS server.

Types of RADIUS Messages

The following types of RADIUS messages are exchanged between the access point and the RADIUS server for user authentication:

- Access-Request
Sent by an access point requesting authentication.
- Access-Reject
Sent by a RADIUS server rejecting access.
- Access-Accept
Sent by a RADIUS server allowing access.
- Access-Challenge
Sent by a RADIUS server requesting more information in order to allow access. The access point sends a proper response from the user and then sends another Access-Request message.

The following types of RADIUS messages are exchanged between the access point and the RADIUS server for user accounting:

- Accounting-Request
Sent by the access point requesting accounting.
- Accounting-Response
Sent by the RADIUS server to indicate that it has started or stopped accounting.

In order to ensure network security, the access point and the RADIUS server use a shared secret key, which is a password, they both know. The key is not sent over the network. In addition to the shared key, password information exchanged is also encrypted to protect the network from unauthorized access.

Types of EAP Authentication

This section discusses some popular authentication types: EAP-MD5, EAP-TLS, EAP-TTLS, PEAP and LEAP. Your wireless LAN device may not support all authentication types.

EAP (Extensible Authentication Protocol) is an authentication protocol that runs on top of the IEEE 802.1x transport mechanism in order to support multiple types of user authentication. By using EAP to interact with an EAP-compatible RADIUS server, an access point helps a wireless station and a RADIUS server perform authentication.

The type of authentication you use depends on the RADIUS server and an intermediary AP(s) that supports IEEE 802.1x.

For EAP-TLS authentication type, you must first have a wired connection to the network and obtain the certificate(s) from a certificate authority (CA). A certificate (also called digital IDs) can be used to authenticate users and a CA issues certificates and guarantees the identity of each certificate owner.

EAP-MD5 (Message-Digest Algorithm 5)

MD5 authentication is the simplest one-way authentication method. The authentication server sends a challenge to the wireless client. The wireless client 'proves' that it knows the password by encrypting the password with the challenge and sends back the information. Password is not sent in plain text.

However, MD5 authentication has some weaknesses. Since the authentication server needs to get the plaintext passwords, the passwords must be stored. Thus someone other than the authentication server may access the password file. In addition, it is possible to impersonate an authentication server as MD5 authentication method does not perform mutual authentication. Finally, MD5 authentication method does not support data encryption with dynamic session key. You must configure WEP encryption keys for data encryption.

EAP-TLS (Transport Layer Security)

With EAP-TLS, digital certifications are needed by both the server and the wireless clients for mutual authentication. The server presents a certificate to the client. After validating the identity of the server, the client sends a different certificate to the server. The exchange of certificates is done in the open before a secured tunnel is created. This makes user identity vulnerable to passive attacks. A digital certificate is an electronic ID card that authenticates the sender's identity. However, to implement EAP-TLS, you need a Certificate Authority (CA) to handle certificates, which imposes a management overhead.

EAP-TTLS (Tunneled Transport Layer Service)

EAP-TTLS is an extension of the EAP-TLS authentication that uses certificates for only the server-side authentications to establish a secure connection. Client authentication is then done by sending username and password through the secure connection, thus client identity is protected. For client authentication, EAP-TTLS supports EAP methods and legacy authentication methods such as PAP, CHAP, MS-CHAP and MS-CHAP v2.

PEAP (Protected EAP)

Like EAP-TTLS, server-side certificate authentication is used to establish a secure connection, then use simple username and password methods through the secured connection to authenticate the clients, thus hiding client identity. However, PEAP only supports EAP methods, such as EAP-MD5, EAP-MSCHAPv2 and EAP-GTC (EAP-Generic Token Card), for client authentication. EAP-GTC is implemented only by Cisco.

LEAP

LEAP (Lightweight Extensible Authentication Protocol) is a Cisco implementation of IEEE 802.1x.

Dynamic WEP Key Exchange

The AP maps a unique key that is generated with the RADIUS server. This key expires when the wireless connection times out, disconnects or reauthentication times out. A new WEP key is generated each time reauthentication is performed.

If this feature is enabled, it is not necessary to configure a default encryption key in the wireless security configuration screen. You may still configure and store keys, but they will not be used while dynamic WEP is enabled.

Note: EAP-MD5 cannot be used with Dynamic WEP Key Exchange

For added security, certificate-based authentications (EAP-TLS, EAP-TTLS and PEAP) use dynamic keys for data encryption. They are often deployed in corporate environments, but for public deployment, a simple user name and password pair is more practical. The following table is a comparison of the features of authentication types.

Table 111 Comparison of EAP Authentication Types

	EAP-MD5	EAP-TLS	EAP-TTLS	PEAP	LEAP
Mutual Authentication	No	Yes	Yes	Yes	Yes
Certificate – Client	No	Yes	Optional	Optional	No
Certificate – Server	No	Yes	Yes	Yes	No
Dynamic Key Exchange	No	Yes	Yes	Yes	Yes
Credential Integrity	None	Strong	Strong	Strong	Moderate
Deployment Difficulty	Easy	Hard	Moderate	Moderate	Moderate
Client Identity Protection	No	No	Yes	Yes	No

WPA and WPA2

Wi-Fi Protected Access (WPA) is a subset of the IEEE 802.11i standard. WPA2 (IEEE 802.11i) is a wireless security standard that defines stronger encryption, authentication and key management than WPA.

Key differences between WPA or WPA2 and WEP are improved data encryption and user authentication.

If both an AP and the wireless clients support WPA2 and you have an external RADIUS server, use WPA2 for stronger data encryption. If you don't have an external RADIUS server, you should use WPA2-PSK (WPA2-Pre-Shared Key) that only requires a single (identical) password entered into each access point, wireless gateway and wireless client. As long as the passwords match, a wireless client will be granted access to a WLAN.

If the AP or the wireless clients do not support WPA2, just use WPA or WPA-PSK depending on whether you have an external RADIUS server or not.

Select WEP only when the AP and/or wireless clients do not support WPA or WPA2. WEP is less secure than WPA or WPA2.

Encryption

WPA improves data encryption by using Temporal Key Integrity Protocol (TKIP), Message Integrity Check (MIC) and IEEE 802.1x. WPA2 also uses TKIP when required for compatibility reasons, but offers stronger encryption than TKIP with Advanced Encryption Standard (AES) in the Counter mode with Cipher block chaining Message authentication code Protocol (CCMP).

TKIP uses 128-bit keys that are dynamically generated and distributed by the authentication server. AES (Advanced Encryption Standard) is a block cipher that uses a 256-bit mathematical algorithm

called Rijndael. They both include a per-packet key mixing function, a Message Integrity Check (MIC) named Michael, an extended initialization vector (IV) with sequencing rules, and a re-keying mechanism.

WPA and WPA2 regularly change and rotate the encryption keys so that the same encryption key is never used twice.

The RADIUS server distributes a Pairwise Master Key (PMK) key to the AP that then sets up a key hierarchy and management system, using the PMK to dynamically generate unique data encryption keys to encrypt every data packet that is wirelessly communicated between the AP and the wireless clients. This all happens in the background automatically.

The Message Integrity Check (MIC) is designed to prevent an attacker from capturing data packets, altering them and resending them. The MIC provides a strong mathematical function in which the receiver and the transmitter each compute and then compare the MIC. If they do not match, it is assumed that the data has been tampered with and the packet is dropped.

By generating unique data encryption keys for every data packet and by creating an integrity checking mechanism (MIC), with TKIP and AES it is more difficult to decrypt data on a Wi-Fi network than WEP and difficult for an intruder to break into the network.

The encryption mechanisms used for WPA(2) and WPA(2)-PSK are the same. The only difference between the two is that WPA(2)-PSK uses a simple common password, instead of user-specific credentials. The common-password approach makes WPA(2)-PSK susceptible to brute-force password-guessing attacks but it's still an improvement over WEP as it employs a consistent, single, alphanumeric password to derive a PMK which is used to generate unique temporal encryption keys. This prevents all wireless devices sharing the same encryption keys. (a weakness of WEP)

User Authentication

WPA and WPA2 apply IEEE 802.1x and Extensible Authentication Protocol (EAP) to authenticate wireless clients using an external RADIUS database. WPA2 reduces the number of key exchange messages from six to four (CCMP 4-way handshake) and shortens the time required to connect to a network. Other WPA2 authentication features that are different from WPA include key caching and pre-authentication. These two features are optional and may not be supported in all wireless devices.

Key caching allows a wireless client to store the PMK it derived through a successful authentication with an AP. The wireless client uses the PMK when it tries to connect to the same AP and does not need to go through the authentication process again.

Pre-authentication enables fast roaming by allowing the wireless client (already connecting to an AP) to perform IEEE 802.1x authentication with another AP before connecting to it.

Wireless Client WPA Supplicants

A wireless client supplicant is the software that runs on an operating system instructing the wireless client how to use WPA. At the time of writing, the most widely available supplicant is the WPA patch for Windows XP, Funk Software's Odyssey client.

The Windows XP patch is a free download that adds WPA capability to Windows XP's built-in "Zero Configuration" wireless client. However, you must run Windows XP to use it.

WPA(2) with RADIUS Application Example

To set up WPA(2), you need the IP address of the RADIUS server, its port number (default is 1812), and the RADIUS shared secret. A WPA(2) application example with an external RADIUS server looks as follows. "A" is the RADIUS server. "DS" is the distribution system.

- 1 The AP passes the wireless client's authentication request to the RADIUS server.
- 2 The RADIUS server then checks the user's identification against its database and grants or denies network access accordingly.
- 3 A 256-bit Pairwise Master Key (PMK) is derived from the authentication process by the RADIUS server and the client.
- 4 The RADIUS server distributes the PMK to the AP. The AP then sets up a key hierarchy and management system, using the PMK to dynamically generate unique data encryption keys. The keys are used to encrypt every data packet that is wirelessly communicated between the AP and the wireless clients.

Figure 180 WPA(2) with RADIUS Application Example

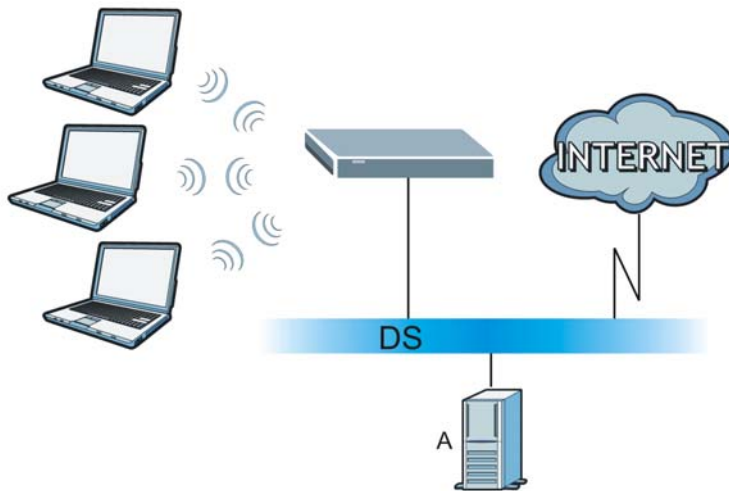

WPA(2)-PSK Application Example

A WPA(2)-PSK application looks as follows.

- 1 First enter identical passwords into the AP and all wireless clients. The Pre-Shared Key (PSK) must consist of between 8 and 63 ASCII characters or 64 hexadecimal characters (including spaces and symbols).
- 2 The AP checks each wireless client's password and allows it to join the network only if the password matches.
- 3 The AP and wireless clients generate a common PMK (Pairwise Master Key). The key itself is not sent over the network, but is derived from the PSK and the SSID.

- 4 The AP and wireless clients use the TKIP or AES encryption process, the PMK and information exchanged in a handshake to create temporal encryption keys. They use these keys to encrypt data exchanged between them.

Figure 181 WPA(2)-PSK Authentication

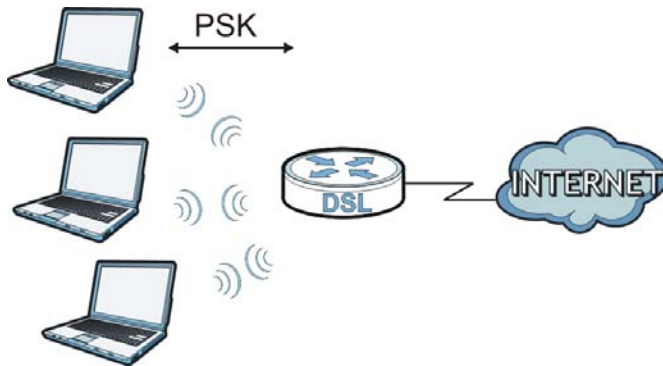

Security Parameters Summary

Refer to this table to see what other security parameters you should configure for each authentication method or key management protocol type. MAC address filters are not dependent on how you configure these security features.

Table 112 Wireless Security Relational Matrix

AUTHENTICATION METHOD/ KEY MANAGEMENT PROTOCOL	ENCRYPTIO N METHOD	ENTER MANUAL KEY	IEEE 802.1X
Open	None	No	Disable
			Enable without Dynamic WEP Key
Open	WEP	No	Enable with Dynamic WEP Key
		Yes	Enable without Dynamic WEP Key
		Yes	Disable
Shared	WEP	No	Enable with Dynamic WEP Key
		Yes	Enable without Dynamic WEP Key
		Yes	Disable
WPA	TKIP/AES	No	Enable
WPA-PSK	TKIP/AES	Yes	Disable
WPA2	TKIP/AES	No	Enable
WPA2-PSK	TKIP/AES	Yes	Disable

Antenna Overview

An antenna couples RF signals onto air. A transmitter within a wireless device sends an RF signal to the antenna, which propagates the signal through the air. The antenna also operates in reverse by capturing RF signals from the air.

Positioning the antennas properly increases the range and coverage area of a wireless LAN.

Antenna Characteristics

Frequency

An antenna in the frequency of 2.4GHz (IEEE 802.11b and IEEE 802.11g) or 5GHz (IEEE 802.11a) is needed to communicate efficiently in a wireless LAN

Radiation Pattern

A radiation pattern is a diagram that allows you to visualize the shape of the antenna's coverage area.

Antenna Gain

Antenna gain, measured in dB (decibel), is the increase in coverage within the RF beam width. Higher antenna gain improves the range of the signal for better communications.

For an indoor site, each 1 dB increase in antenna gain results in a range increase of approximately 2.5%. For an unobstructed outdoor site, each 1dB increase in gain results in a range increase of approximately 5%. Actual results may vary depending on the network environment.

Antenna gain is sometimes specified in dBi, which is how much the antenna increases the signal power compared to using an isotropic antenna. An isotropic antenna is a theoretical perfect antenna that sends out radio signals equally well in all directions. dBi represents the true gain that the antenna provides.

Types of Antennas for WLAN

There are two types of antennas used for wireless LAN applications.

- Omni-directional antennas send the RF signal out in all directions on a horizontal plane. The coverage area is torus-shaped (like a donut) which makes these antennas ideal for a room environment. With a wide coverage area, it is possible to make circular overlapping coverage areas with multiple access points.
- Directional antennas concentrate the RF signal in a beam, like a flashlight does with the light from its bulb. The angle of the beam determines the width of the coverage pattern. Angles typically range from 20 degrees (very directional) to 120 degrees (less directional). Directional antennas are ideal for hallways and outdoor point-to-point applications.

Positioning Antennas

In general, antennas should be mounted as high as practically possible and free of obstructions. In point-to-point application, position both antennas at the same height and in a direct line of sight to each other to attain the best performance.

For omni-directional antennas mounted on a table, desk, and so on, point the antenna up. For omni-directional antennas mounted on a wall or ceiling, point the antenna down. For a single AP application, place omni-directional antennas as close to the center of the coverage area as possible.

For directional antennas, point the antenna in the direction of the desired coverage area.

Overview

IPv6 (Internet Protocol version 6), is designed to enhance IP address size and features. The increase in IPv6 address size to 128 bits (from the 32-bit IPv4 address) allows up to 3.4×10^{38} IP addresses.

IPv6 Addressing

The 128-bit IPv6 address is written as eight 16-bit hexadecimal blocks separated by colons (:). This is an example IPv6 address `2001:0db8:1a2b:0015:0000:0000:1a2f:0000`.

IPv6 addresses can be abbreviated in two ways:

- Leading zeros in a block can be omitted. So `2001:0db8:1a2b:0015:0000:0000:1a2f:0000` can be written as `2001:db8:1a2b:15:0:0:1a2f:0`.
- Any number of consecutive blocks of zeros can be replaced by a double colon. A double colon can only appear once in an IPv6 address. So `2001:0db8:0000:0000:1a2f:0000:0000:0015` can be written as `2001:0db8::1a2f:0000:0000:0015`, `2001:0db8:0000:0000:1a2f::0015`, `2001:db8::1a2f:0:0:15` or `2001:db8:0:0:1a2f::15`.

Prefix and Prefix Length

Similar to an IPv4 subnet mask, IPv6 uses an address prefix to represent the network address. An IPv6 prefix length specifies how many most significant bits (start from the left) in the address compose the network address. The prefix length is written as "/x" where x is a number. For example,

`2001:db8:1a2b:15::1a2f:0/32`

means that the first 32 bits (`2001:db8`) is the subnet prefix.

Link-local Address

A link-local address uniquely identifies a device on the local network (the LAN). It is similar to a "private IP address" in IPv4. You can have the same link-local address on multiple interfaces on a device. A link-local unicast address has a predefined prefix of `fe80::/10`. The link-local unicast address format is as follows.

Table 113 Link-local Unicast Address Format

1111 1110 10	0	Interface ID
10 bits	54 bits	64 bits

Global Address

A global address uniquely identifies a device on the Internet. It is similar to a “public IP address” in IPv4. A global unicast address starts with a 2 or 3.

Unspecified Address

An unspecified address (0:0:0:0:0:0:0:0 or ::) is used as the source address when a device does not have its own address. It is similar to “0.0.0.0” in IPv4.

Loopback Address

A loopback address (0:0:0:0:0:0:0:1 or ::1) allows a host to send packets to itself. It is similar to “127.0.0.1” in IPv4.

Multicast Address

In IPv6, multicast addresses provide the same functionality as IPv4 broadcast addresses. Broadcasting is not supported in IPv6. A multicast address allows a host to send packets to all hosts in a multicast group.

Multicast scope allows you to determine the size of the multicast group. A multicast address has a predefined prefix of ff00::/8. The following table describes some of the predefined multicast addresses.

Table 114 Predefined Multicast Address

MULTICAST ADDRESS	DESCRIPTION
FF01:0:0:0:0:0:0:1	All hosts on a local node.
FF01:0:0:0:0:0:0:2	All routers on a local node.
FF02:0:0:0:0:0:0:1	All hosts on a local connected link.
FF02:0:0:0:0:0:0:2	All routers on a local connected link.
FF05:0:0:0:0:0:0:2	All routers on a local site.
FF05:0:0:0:0:0:1:3	All DHCP servers on a local site.

The following table describes the multicast addresses which are reserved and can not be assigned to a multicast group.

Table 115 Reserved Multicast Address

MULTICAST ADDRESS
FF00:0:0:0:0:0:0:0
FF01:0:0:0:0:0:0:0
FF02:0:0:0:0:0:0:0
FF03:0:0:0:0:0:0:0
FF04:0:0:0:0:0:0:0
FF05:0:0:0:0:0:0:0
FF06:0:0:0:0:0:0:0
FF07:0:0:0:0:0:0:0

Table 115 Reserved Multicast Address (continued)

MULTICAST ADDRESS
FF08:0:0:0:0:0:0:0
FF09:0:0:0:0:0:0:0
FF0A:0:0:0:0:0:0:0
FF0B:0:0:0:0:0:0:0
FF0C:0:0:0:0:0:0:0
FF0D:0:0:0:0:0:0:0
FF0E:0:0:0:0:0:0:0
FF0F:0:0:0:0:0:0:0

Subnet Masking

Both an IPv6 address and IPv6 subnet mask compose of 128-bit binary digits, which are divided into eight 16-bit blocks and written in hexadecimal notation. Hexadecimal uses four bits for each character (1 ~ 10, A ~ F). Each block's 16 bits are then represented by four hexadecimal characters. For example, FFFF:FFFF:FFFF:FFFF:FC00:0000:0000:0000.

Interface ID

In IPv6, an interface ID is a 64-bit identifier. It identifies a physical interface (for example, an Ethernet port) or a virtual interface (for example, the management IP address for a VLAN). One interface should have a unique interface ID.

EUI-64

The EUI-64 (Extended Unique Identifier) defined by the IEEE (Institute of Electrical and Electronics Engineers) is an interface ID format designed to adapt with IPv6. It is derived from the 48-bit (6-byte) Ethernet MAC address as shown next. EUI-64 inserts the hex digits ffe between the third and fourth bytes of the MAC address and complements the seventh bit of the first byte of the MAC address. See the following example.

MAC	00 : 13 : 49 : 12 : 34 : 56
EUI-64	02 : 13 : 49 : FF : FE : 12 : 34 : 56

Stateless Autoconfiguration

With stateless autoconfiguration in IPv6, addresses can be uniquely and automatically generated. Unlike DHCPv6 (Dynamic Host Configuration Protocol version six) which is used in IPv6 stateful autoconfiguration, the owner and status of addresses don't need to be maintained by a DHCP server. Every IPv6 device is able to generate its own and unique IP address automatically when IPv6 is initiated on its interface. It combines the prefix and the interface ID (generated from its own Ethernet MAC address, see [Interface ID](#) and [EUI-64](#)) to form a complete IPv6 address.

When IPv6 is enabled on a device, its interface automatically generates a link-local address (beginning with fe80).

When the interface is connected to a network with a router and the AMG1312-T Series is set to automatically obtain an IPv6 network prefix from the router for the interface, it generates ³another

address which combines its interface ID and global and subnet information advertised from the router. This is a routable global IP address.

DHCPv6

The Dynamic Host Configuration Protocol for IPv6 (DHCPv6, RFC 3315) is a server-client protocol that allows a DHCP server to assign and pass IPv6 network addresses, prefixes and other configuration information to DHCP clients. DHCPv6 servers and clients exchange DHCP messages using UDP.

Each DHCP client and server has a unique DHCP Unique Identifier (DUID), which is used for identification when they are exchanging DHCPv6 messages. The DUID is generated from the MAC address, time, vendor assigned ID and/or the vendor's private enterprise number registered with the IANA. It should not change over time even after you reboot the device.

Identity Association

An Identity Association (IA) is a collection of addresses assigned to a DHCP client, through which the server and client can manage a set of related IP addresses. Each IA must be associated with exactly one interface. The DHCP client uses the IA assigned to an interface to obtain configuration from a DHCP server for that interface. Each IA consists of a unique IAID and associated IP information.

The IA type is the type of address in the IA. Each IA holds one type of address. IA_NA means an identity association for non-temporary addresses and IA_TA is an identity association for temporary addresses. An IA_NA option contains the T1 and T2 fields, but an IA_TA option does not. The DHCPv6 server uses T1 and T2 to control the time at which the client contacts with the server to extend the lifetimes on any addresses in the IA_NA before the lifetimes expire. After T1, the client sends the server (S1) (from which the addresses in the IA_NA were obtained) a Renew message. If the time T2 is reached and the server does not respond, the client sends a Rebind message to any available server (S2). For an IA_TA, the client may send a Renew or Rebind message at the client's discretion.

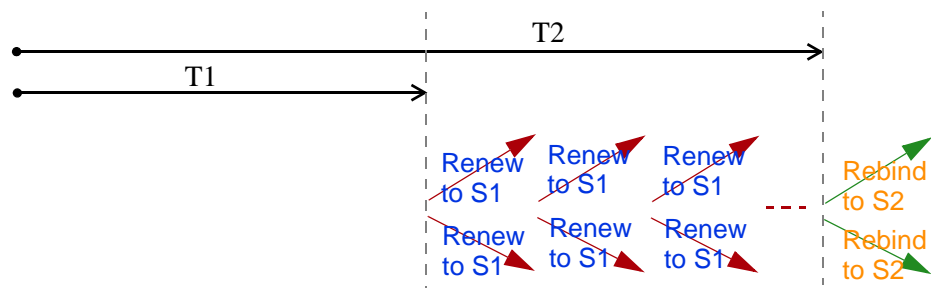

DHCP Relay Agent

A DHCP relay agent is on the same network as the DHCP clients and helps forward messages between the DHCP server and clients. When a client cannot use its link-local address and a well-known multicast address to locate a DHCP server on its network, it then needs a DHCP relay agent to send a message to a DHCP server that is not attached to the same network.

The DHCP relay agent can add the remote identification (remote-ID) option and the interface-ID option to the Relay-Forward DHCPv6 messages. The remote-ID option carries a user-defined string,

3. In IPv6, all network interfaces can be associated with several addresses.

such as the system name. The interface-ID option provides slot number, port information and the VLAN ID to the DHCPv6 server. The remote-ID option (if any) is stripped from the Relay-Reply messages before the relay agent sends the packets to the clients. The DHCP server copies the interface-ID option from the Relay-Forward message into the Relay-Reply message and sends it to the relay agent. The interface-ID should not change even after the relay agent restarts.

Prefix Delegation

Prefix delegation enables an IPv6 router to use the IPv6 prefix (network address) received from the ISP (or a connected uplink router) for its LAN. The AMG1312-T Series uses the received IPv6 prefix (for example, 2001:db2::/48) to generate its LAN IP address. Through sending Router Advertisements (RAs) regularly by multicast, the AMG1312-T Series passes the IPv6 prefix information to its LAN hosts. The hosts then can use the prefix to generate their IPv6 addresses.

ICMPv6

Internet Control Message Protocol for IPv6 (ICMPv6 or ICMP for IPv6) is defined in RFC 4443. ICMPv6 has a preceding Next Header value of 58, which is different from the value used to identify ICMP for IPv4. ICMPv6 is an integral part of IPv6. IPv6 nodes use ICMPv6 to report errors encountered in packet processing and perform other diagnostic functions, such as "ping".

Multicast Listener Discovery

The Multicast Listener Discovery (MLD) protocol (defined in RFC 2710) is derived from IPv4's Internet Group Management Protocol version 2 (IGMPv2). MLD uses ICMPv6 message types, rather than IGMP message types. MLDv1 is equivalent to IGMPv2 and MLDv2 is equivalent to IGMPv3.

MLD allows an IPv6 switch or router to discover the presence of MLD listeners who wish to receive multicast packets and the IP addresses of multicast groups the hosts want to join on its network.

MLD snooping and MLD proxy are analogous to IGMP snooping and IGMP proxy in IPv4.

MLD filtering controls which multicast groups a port can join.

MLD Messages

A multicast router or switch periodically sends general queries to MLD hosts to update the multicast forwarding table. When an MLD host wants to join a multicast group, it sends an MLD Report message for that address.

An MLD Done message is equivalent to an IGMP Leave message. When an MLD host wants to leave a multicast group, it can send a Done message to the router or switch. The router or switch then sends a group-specific query to the port on which the Done message is received to determine if other devices connected to this port should remain in the group.

Transition Techniques

IPv6 Over IPv4 Tunnelling

To route traffic between two IPv6 networks over an IPv4 network, an IPv6 over IPv4 tunnel has to be used.

On the AMG1312-T Series, you can either set up a configured tunnel or an automatic 6to4 tunnel. The following describes each method.

Configured Tunnel

A configured tunnel is a point-to-point tunnelling mechanism that encapsulates an IPv6 address with an IPv4 address. Routers (**A** and **B**) on both IPv6 networks (**1** and **2**) each must have an interface that connects to the IPv4 network (with an IPv4 address). This allows the router to send and receive IPv6 data over the IPv4 network.

In this case, you must specify **B**'s public IPv4 address on **A** (similarly, specify **A**'s public IPv4 address on **B**) in order for packets to arrive at the intended destination through the IPv4 network.

Figure 182 Configured Tunnel Example



6to4 Tunnel

A 6to4 tunnel is an automatic tunnelling mechanism that provides connection between IPv6 networks across an IPv4 network. To transmit IPv6 packets over an IPv4 network, the IPv6 packets are encapsulated inside IPv4 packets.

The following figure shows a network example.

Figure 183 6to4 Relay Router Network Example

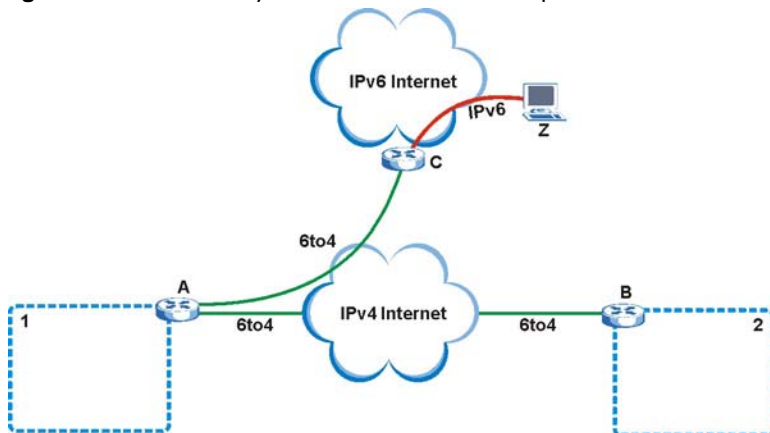

In a 6to4 tunnel, 6to4 routers (**A** and **B** in the example network) forward these packets between IPv6 networks (**1** and **2**) over the IPv4 Internet. A 6to4 relay router (**C**) connects to both an IPv6 and IPv4 network. A 6to4 relay router is used to forward packets between 6to4 routers in an IPv4 Internet and an IPv6 device (**Z**) on the IPv6 Internet.

To transmit packets, a 6to4 address is used with a special IPv6 prefix of `2002::` to encode a given IPv4 address. A 6to4 address has the following format:

`2002:IPv4 address:subnet ID:host ID/64`

For example, if you have an IPv4 address of 192.168.1.1 (first converted to binary notation and then to the colon hexadecimal representation of c0a8:0101), then the 6to4 addresses is 2002:c0a8:0101::1/64.

Example - Enabling IPv6 on Windows XP/2003/Vista

By default, Windows XP and Windows 2003 support IPv6. This example shows you how to use the `ipv6 install` command on Windows XP/2003 to enable IPv6. This also displays how to use the `ipconfig` command to see auto-generated IP addresses.

```
C:\>ipv6 install
Installing...
Succeeded.

C:\>ipconfig

Windows IP Configuration

Ethernet adapter Local Area Connection:

    Connection-specific DNS Suffix  . :
    IP Address. . . . . : 10.1.1.46
    Subnet Mask . . . . . : 255.255.255.0
    IP Address. . . . . : fe80::2d0:59ff:feb8:103c%4
    Default Gateway . . . . . : 10.1.1.254
```

IPv6 is installed and enabled by default in Windows Vista. Use the `ipconfig` command to check your automatic configured IPv6 address as well. You should see at least one IPv6 address available for the interface on your computer.

Example - Enabling DHCPv6 on Windows XP

Windows XP does not support DHCPv6. If your network uses DHCPv6 for IP address assignment, you have to additionally install a DHCPv6 client software on your Windows XP. (Note: If you use static IP addresses or Router Advertisement for IPv6 address assignment in your network, ignore this section.)

This example uses Dibbler as the DHCPv6 client. To enable DHCPv6 client on your computer:

- 1 Install Dibbler and select the DHCPv6 client option on your computer.
- 2 After the installation is complete, select **Start > All Programs > Dibbler-DHCPv6 > Client Install as service.**
- 3 Select **Start > Control Panel > Administrative Tools > Services.**
- 4 Double click **Dibbler - a DHCPv6 client.**

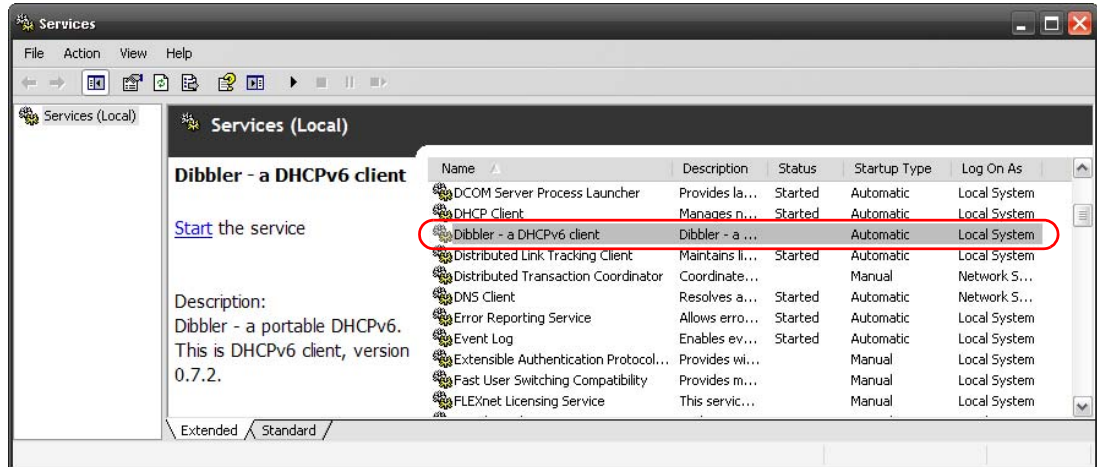

- 5 Click **Start** and then **OK**.

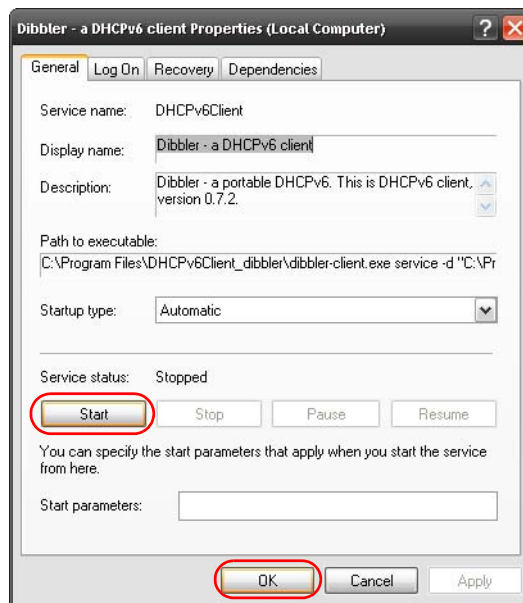

- 6 Now your computer can obtain an IPv6 address from a DHCPv6 server.

Example - Enabling IPv6 on Windows 7

Windows 7 supports IPv6 by default. DHCPv6 is also enabled when you enable IPv6 on a Windows 7 computer.

To enable IPv6 in Windows 7:

- 1 Select **Control Panel > Network and Sharing Center > Local Area Connection**.
- 2 Select the **Internet Protocol Version 6 (TCP/IPv6)** checkbox to enable it.
- 3 Click **OK** to save the change.

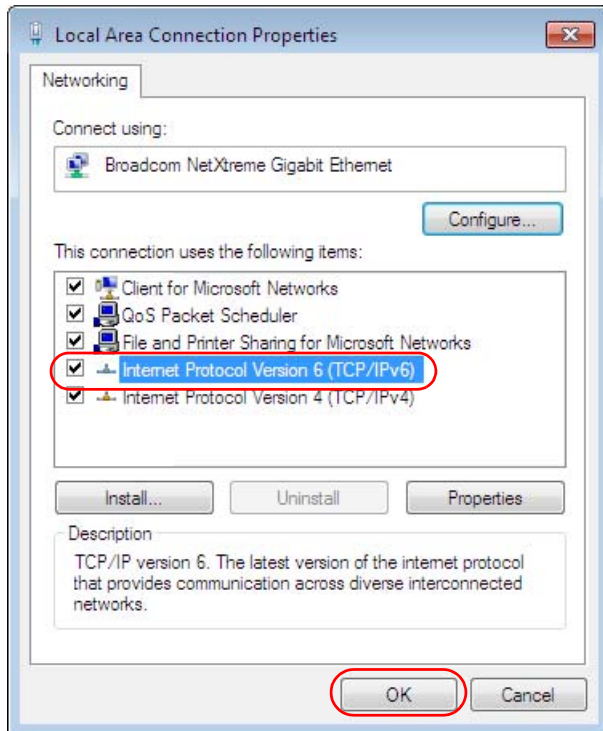

- 4 Click **Close** to exit the **Local Area Connection Status** screen.
- 5 Select **Start > All Programs > Accessories > Command Prompt**.
- 6 Use the `ipconfig` command to check your dynamic IPv6 address. This example shows a global address (`2001:b021:2d::1000`) obtained from a DHCP server.

```
C:\>ipconfig

Windows IP Configuration

Ethernet adapter Local Area Connection:

    Connection-specific DNS Suffix  . :
    IPv6 Address. . . . . : 2001:b021:2d::1000
    Link-local IPv6 Address . . . . . : fe80::25d8:dcab:c80a:5189%11
    IPv4 Address. . . . . : 172.16.100.61
    Subnet Mask . . . . . : 255.255.255.0
    Default Gateway . . . . . : fe80::213:49ff:feaa:7125%11
                                172.16.100.254
```

Services

The following table lists some commonly-used services and their associated protocols and port numbers.

- **Name:** This is a short, descriptive name for the service. You can use this one or create a different one, if you like.
- **Protocol:** This is the type of IP protocol used by the service. If this is **TCP/UDP**, then the service uses the same port number with TCP and UDP. If this is **USER-DEFINED**, the **Port(s)** is the IP protocol number, not the port number.
- **Port(s):** This value depends on the **Protocol**.
 - If the **Protocol** is **TCP, UDP, or TCP/UDP**, this is the IP port number.
 - If the **Protocol** is **USER**, this is the IP protocol number.
- **Description:** This is a brief explanation of the applications that use this service or the situations in which this service is used.

Table 116 Examples of Services

NAME	PROTOCOL	PORT(S)	DESCRIPTION
AH (IPSEC_TUNNEL)	User-Defined	51	The IPSEC AH (Authentication Header) tunneling protocol uses this service.
AIM	TCP	5190	AOL's Internet Messenger service.
AUTH	TCP	113	Authentication protocol used by some servers.
BGP	TCP	179	Border Gateway Protocol.
BOOTP_CLIENT	UDP	68	DHCP Client.
BOOTP_SERVER	UDP	67	DHCP Server.
CU-SEEME	TCP/UDP TCP/UDP	7648 24032	A popular videoconferencing solution from White Pines Software.
DNS	TCP/UDP	53	Domain Name Server, a service that matches web names (for instance www.zyxel.com) to IP numbers.
ESP (IPSEC_TUNNEL)	User-Defined	50	The IPSEC ESP (Encapsulation Security Protocol) tunneling protocol uses this service.
FINGER	TCP	79	Finger is a UNIX or Internet related command that can be used to find out if a user is logged on.
FTP	TCP TCP	20 21	File Transfer Protocol, a program to enable fast transfer of files, including large files that may not be possible by e-mail.
H.323	TCP	1720	NetMeeting uses this protocol.
HTTP	TCP	80	Hyper Text Transfer Protocol - a client/server protocol for the world wide web.
HTTPS	TCP	443	HTTPS is a secured http session often used in e-commerce.
ICMP	User-Defined	1	Internet Control Message Protocol is often used for diagnostic purposes.
ICQ	UDP	4000	This is a popular Internet chat program.
IGMP (MULTICAST)	User-Defined	2	Internet Group Multicast Protocol is used when sending packets to a specific group of hosts.
IKE	UDP	500	The Internet Key Exchange algorithm is used for key distribution and management.
IMAP4	TCP	143	The Internet Message Access Protocol is used for e-mail.
IMAP4S	TCP	993	This is a more secure version of IMAP4 that runs over SSL.
IRC	TCP/UDP	6667	This is another popular Internet chat program.
MSN Messenger	TCP	1863	Microsoft Networks' messenger service uses this protocol.
NetBIOS	TCP/UDP TCP/UDP TCP/UDP TCP/UDP	137 138 139 445	The Network Basic Input/Output System is used for communication between computers in a LAN.

Table 116 Examples of Services (continued)

NAME	PROTOCOL	PORT(S)	DESCRIPTION
NEW-ICQ	TCP	5190	An Internet chat program.
NEWS	TCP	144	A protocol for news groups.
NFS	UDP	2049	Network File System - NFS is a client/server distributed file service that provides transparent file sharing for network environments.
NNTP	TCP	119	Network News Transport Protocol is the delivery mechanism for the USENET newsgroup service.
PING	User-Defined	1	Packet INTERNet Groper is a protocol that sends out ICMP echo requests to test whether or not a remote host is reachable.
POP3	TCP	110	Post Office Protocol version 3 lets a client computer get e-mail from a POP3 server through a temporary connection (TCP/IP or other).
POP3S	TCP	995	This is a more secure version of POP3 that runs over SSL.
PPTP	TCP	1723	Point-to-Point Tunneling Protocol enables secure transfer of data over public networks. This is the control channel.
PPTP_TUNNEL (GRE)	User-Defined	47	PPTP (Point-to-Point Tunneling Protocol) enables secure transfer of data over public networks. This is the data channel.
RCMD	TCP	512	Remote Command Service.
REAL_AUDIO	TCP	7070	A streaming audio service that enables real time sound over the web.
REXEC	TCP	514	Remote Execution Daemon.
RLOGIN	TCP	513	Remote Login.
ROADRUNNER	TCP/UDP	1026	This is an ISP that provides services mainly for cable modems.
RTELNET	TCP	107	Remote Telnet.
RTSP	TCP/UDP	554	The Real Time Streaming (media control) Protocol (RTSP) is a remote control for multimedia on the Internet.
SFTP	TCP	115	The Simple File Transfer Protocol is an old way of transferring files between computers.
SMTP	TCP	25	Simple Mail Transfer Protocol is the message-exchange standard for the Internet. SMTP enables you to move messages from one e-mail server to another.
SMTPS	TCP	465	This is a more secure version of SMTP that runs over SSL.
SNMP	TCP/UDP	161	Simple Network Management Program.
SNMP-TRAPS	TCP/UDP	162	Traps for use with the SNMP (RFC:1215).

Table 116 Examples of Services (continued)

NAME	PROTOCOL	PORT(S)	DESCRIPTION
SQL-NET	TCP	1521	Structured Query Language is an interface to access data on many different types of database systems, including mainframes, midrange systems, UNIX systems and network servers.
SSDP	UDP	1900	The Simple Service Discovery Protocol supports Universal Plug-and-Play (UPnP).
SSH	TCP/UDP	22	Secure Shell Remote Login Program.
STRM WORKS	UDP	1558	Stream Works Protocol.
SYSLOG	UDP	514	Syslog allows you to send system logs to a UNIX server.
TACACS	UDP	49	Login Host Protocol used for (Terminal Access Controller Access Control System).
TELNET	TCP	23	Telnet is the login and terminal emulation protocol common on the Internet and in UNIX environments. It operates over TCP/IP networks. Its primary function is to allow users to log into remote host systems.
VDOLIVE	TCP UDP	7000 user- defined	A videoconferencing solution. The UDP port number is specified in the application.

Legal Information

Copyright

Copyright © 2013 by ZyXEL Communications Corporation.

The contents of this publication may not be reproduced in any part or as a whole, transcribed, stored in a retrieval system, translated into any language, or transmitted in any form or by any means, electronic, mechanical, magnetic, optical, chemical, photocopying, manual, or otherwise, without the prior written permission of ZyXEL Communications Corporation.

Published by ZyXEL Communications Corporation. All rights reserved.

Disclaimer

ZyXEL does not assume any liability arising out of the application or use of any products, or software described herein. Neither does it convey any license under its patent rights nor the patent rights of others. ZyXEL further reserves the right to make changes in any products described herein without notice. This publication is subject to change without notice.

Trademarks

ZyNOS (ZyXEL Network Operating System) is a registered trademark of ZyXEL Communications, Inc. Other trademarks mentioned in this publication are used for identification purposes only and may be properties of their respective owners.

Certifications

Federal Communications Commission (FCC) Interference Statement

The device complies with Part 15 of FCC rules. Operation is subject to the following two conditions:

- This device may not cause harmful interference.
- This device must accept any interference received, including interference that may cause undesired operations.

This device has been tested and found to comply with the limits for a Class B digital device pursuant to Part 15 of the FCC Rules. These limits are designed to provide reasonable protection against harmful interference in a residential installation. This device generates, uses, and can radiate radio frequency energy, and if not installed and used in accordance with the instructions, may cause harmful interference to radio communications. However, there is no guarantee that interference will not occur in a particular installation.

If this device does cause harmful interference to radio/television reception, which can be determined by turning the device off and on, the user is encouraged to try to correct the interference by one or more of the following measures:

- 1 Reorient or relocate the receiving antenna.
- 2 Increase the separation between the equipment and the receiver.
- 3 Connect the equipment into an outlet on a circuit different from that to which the receiver is connected.
- 4 Consult the dealer or an experienced radio/TV technician for help.



FCC Radiation Exposure Statement

- This transmitter must not be co-located or operating in conjunction with any other antenna or transmitter.
- IEEE 802.11b, 802.11g or 802.11n(20MHz) operation of this product in the U.S.A. is firmware-limited to channels 1 through 11. IEEE 802.11n(40MHz) operation of this product in the U.S.A. is firmware-limited to channels 3 through 9.
- To comply with FCC RF exposure compliance requirements, a separation distance of at least 20 cm must be maintained between the antenna of this device and all persons.

Note: only channels 1 to 11 (frequency band 2.412 GHz to 2.462 GHz) are available for use in the United States of America.

注意！

依據 低功率電波輻射性電機管理辦法

第十二條 經型式認證合格之低功率射頻電機，非經許可，公司、商號或使用
者均不得擅自變更頻率、加大功率或變更原設計之特性及功能。

第十四條 低功率射頻電機之使用不得影響飛航安全及干擾合法通信；經發現
有干擾現象時，應立即停用，並改善至無干擾時方得繼續使用。
前項合法通信，指依電信規定作業之無線電信。低功率射頻電機須忍
受合法通信或工業、科學及醫療用電波輻射性電機設備之干擾。

本機限在不干擾合法電臺與不受被干擾保障條件下於室內使用。
減少電磁波影響，請妥適使用。

Notices

Changes or modifications not expressly approved by the party responsible for compliance could void the user's authority to operate the equipment.

This Class B digital apparatus complies with Canadian ICES-003.

Cet appareil numérique de la classe B est conforme à la norme NMB-003 du Canada.

Viewing Certifications

Go to www.zyxel.com to view the product's documents and certifications.

ZyXEL Limited Warranty

ZyXEL warrants to the original end user (purchaser) that this product is free from any defects in materials or workmanship for a period of up to two years from the date of purchase. During the warranty period, and upon proof of purchase, should the product have indications of failure due to faulty workmanship and/or materials, ZyXEL will, at its discretion, repair or replace the defective products or components without charge for either parts or labor, and to whatever extent it shall deem necessary to restore the product or components to proper operating condition. Any replacement will consist of a new or re-manufactured functionally equivalent product of equal or higher value, and will be solely at the discretion of ZyXEL. This warranty shall not apply if the product has been modified, misused, tampered with, damaged by an act of God, or subjected to abnormal working conditions.

Note

Repair or replacement, as provided under this warranty, is the exclusive remedy of the purchaser. This warranty is in lieu of all other warranties, express or implied, including any implied warranty of merchantability or fitness for a particular use or purpose. ZyXEL shall in no event be held liable for indirect or consequential damages of any kind to the purchaser.

To obtain the services of this warranty, contact ZyXEL's Service Center for your Return Material Authorization number (RMA). Products must be returned Postage Prepaid. It is recommended that the unit be insured when shipped. Any returned products without proof of purchase or those with an out-dated warranty will be repaired or replaced (at the discretion of ZyXEL) and the customer will be billed for parts and labor. All repaired or replaced products will be shipped by ZyXEL to the corresponding return address, Postage Paid. This warranty gives you specific legal rights, and you may also have other rights that vary from country to country.

Registration

Register your product online to receive e-mail notices of firmware upgrades and information at www.zyxel.com for global products, or at www.us.zyxel.com for North American products.

Regulatory Information

European Union

The following information applies if you use the product within the European Union.

Declaration of Conformity with Regard to EU Directive 1999/5/EC (R&TTE Directive)

Compliance Information for 2.4GHz and 5GHz Wireless Products Relevant to the EU and Other Countries Following the EU Directive 1999/5/EC (R&TTE Directive)

[Czech]	ZyXEL tímto prohlašuje, že tento zařízení je ve shodě se základními požadavky a dalšími příslušnými ustanoveními směrnice 1999/5/EC.
[Danish]	Undertegnede ZyXEL erklærer herved, at følgende udstyr overholder de væsentlige krav og øvrige relevante krav i direktiv 1999/5/EF.
[German]	Hiermit erkläre ZyXEL, dass sich das Gerät Ausstattung in Übereinstimmung mit den grundlegenden Anforderungen und den übrigen einschlägigen Bestimmungen der Richtlinie 1999/5/EU befindet.
[Estonian]	Käesolevaga kinnitab ZyXEL seadme seadmed vastavust direktiivi 1999/5/EÜ põhinõuetele ja nimetatud direktiivist tulenevatele teistele asjakohastele sätetele.
English	Hereby, ZyXEL declares that this equipment is in compliance with the essential requirements and other relevant provisions of Directive 1999/5/EC.
[Spanish]	Por medio de la presente ZyXEL declara que el equipo cumple con los requisitos esenciales y cualesquiera otras disposiciones aplicables o exigibles de la Directiva 1999/5/CE.
[Greek]	ΜΕ ΤΗΝ ΠΑΡΟΥΣΑ ΖΥΧΕΛ ΔΗΛΩΝΕΙ ΟΤΙ ΕΞΟΛΙΣΜΟΣ ΣΥΜΜΟΡΦΩΝΕΤΑΙ ΠΡΟΣ ΤΙΣ ΟΥΣΙΩΔΕΙΣ ΑΠΑΙΤΗΣΕΙΣ ΚΑΙ ΤΙΣ ΛΟΙΠΕΣ ΣΧΕΤΙΚΕΣ ΔΙΑΤΑΞΕΙΣ ΤΗΣ ΟΔΗΓΙΑΣ 1999/5/ΕΚ.
[French]	Par la présente ZyXEL déclare que l'appareil équipements est conforme aux exigences essentielles et aux autres dispositions pertinentes de la directive 1999/5/EC.
[Italian]	Con la presente ZyXEL dichiara che questo attrezzatura è conforme ai requisiti essenziali ed alle altre disposizioni pertinenti stabilite dalla direttiva 1999/5/CE.
[Latvian]	Ar šo ZyXEL deklarē, ka iekārtas atbilst Direktīvas 1999/5/EK būtiskajām prasībām un citiem ar to saistītajiem noteikumiem.
[Lithuanian]	Šiuo ZyXEL deklaruoja, kad šis įranga atitinka esminius reikalavimus ir kitas 1999/5/EB Direktyvos nuostatas.
[Dutch]	Hierbij verklaart ZyXEL dat het toestel uitrusting in overeenstemming is met de essentiële eisen en de andere relevante bepalingen van richtlijn 1999/5/EC.
[Maltese]	Hawnhekk, ZyXEL, jiddikjara li dan taghmir jikkonforma mal-htigijiet essenzjali u ma provvedimenti oħrajn rilevanti li hemm fid-Dirrettiva 1999/5/EC.

[Hungarian]	Alulírott, ZyXEL nyilatkozom, hogy a berendezés megfelel a vonatkozó alapvető követelményeknek és az 1999/5/EK irányelv egyéb előírásainak.
[Polish]	Niniejszym ZyXEL oświadczam, że sprzęt jest zgodny z zasadniczymi wymogami oraz pozostałymi stosownymi postanowieniami Dyrektywy 1999/5/EC.
[Portuguese]	ZyXEL declara que este equipamento está conforme com os requisitos essenciais e outras disposições da Directiva 1999/5/EC.
[Slovenian]	ZyXEL izjavlja, da je ta oprema v skladu z bistvenimi zahtevami in ostalimi relevantnimi določili direktive 1999/5/EC.
[Slovak]	ZyXEL týmto vyhlasuje, že zariadenia spĺňa základné požiadavky a všetky príslušné ustanovenia Smernice 1999/5/EC.
[Finnish]	ZyXEL vakuuttaa täten että laitteet tyyppinen laite on direktiivin 1999/5/EY oleellisten vaatimusten ja sitä koskevien direktiivin muiden ehtojen mukainen.
[Swedish]	Härmed intygar ZyXEL att denna utrustning står i överensstämmelse med de väsentliga egenskapskrav och övriga relevanta bestämmelser som framgår av direktiv 1999/5/EC.
[Bulgarian]	С настоящото ZyXEL декларира, че това оборудване е в съответствие със съществените изисквания и другите приложими разпоредбите на Директива 1999/5/EC.
[Icelandic]	Hér með lýsir, ZyXEL því yfir að þessi búnaður er í samræmi við grunnkröfur og önnur viðeigandi ákvæði tilskipunar 1999/5/EC.
[Norwegian]	Erklærer herved ZyXEL at dette utstyret er i samsvar med de grunnleggende kravene og andre relevante bestemmelser i direktiv 1999/5/EF.
[Romanian]	Prin prezenta, ZyXEL declară că acest echipament este în conformitate cu cerințele esențiale și alte prevederi relevante ale Directivei 1999/5/EC.



National Restrictions

This product may be used in all EU countries (and other countries following the EU directive 1999/5/EC) without any limitation except for the countries mentioned below:

Ce produit peut être utilisé dans tous les pays de l'UE (et dans tous les pays ayant transposés la directive 1999/5/CE) sans aucune limitation, excepté pour les pays mentionnés ci-dessous:

Questo prodotto è utilizzabile in tutte i paesi EU (ed in tutti gli altri paesi che seguono le direttive EU 1999/5/EC) senza nessuna limitazione, eccetto per i paesi menzionati di seguito:

Das Produkt kann in allen EU Staaten ohne Einschränkungen eingesetzt werden (sowie in anderen Staaten die der EU Direktive 1995/5/CE folgen) mit Ausnahme der folgenden aufgeführten Staaten:

In the majority of the EU and other European countries, the 2,4- and 5-GHz bands have been made available for the use of wireless local area networks (LANs). Later in this document you will find an overview of countries in which additional restrictions or requirements or both are applicable.

The requirements for any country may evolve. ZyXEL recommends that you check with the local authorities for the latest status of their national regulations for both the 2,4- and 5-GHz wireless LANs.

The following countries have restrictions and/or requirements in addition to those given in the table labeled "Overview of Regulatory Requirements for Wireless LANs":

Overview of Regulatory Requirements for Wireless LANs			
Frequency Band (MHz)	Max Power Level (EIRP) ¹ (mW)	Indoor ONLY	Indoor and Outdoor
2400-2483.5	100		V
5150-5350	200	V	
5470-5725	1000		V

Belgium

The Belgian Institute for Postal Services and Telecommunications (BIPT) must be notified of any outdoor wireless link having a range exceeding 300 meters. Please check <http://www.bipt.be> for more details.

Draadloze verbindingen voor buitengebruik en met een reikwijdte van meer dan 300 meter dienen aangemeld te worden bij het Belgisch Instituut voor postdiensten en telecommunicatie (BIPT). Zie <http://www.bipt.be> voor meer gegevens.

Les liaisons sans fil pour une utilisation en extérieur d'une distance supérieure à 300 mètres doivent être notifiées à l'Institut Belge des services Postaux et des Télécommunications (IBPT). Visitez <http://www.ibpt.be> pour de plus amples détails.

Denmark

In Denmark, the band 5150 - 5350 MHz is also allowed for outdoor usage.

I Danmark må frekvensbåndet 5150 - 5350 også anvendes udendørs.

Italy

This product meets the National Radio Interface and the requirements specified in the National Frequency Allocation Table for Italy. Unless this wireless LAN product is operating within the boundaries of the owner's property, its use requires a "general authorization." Please check <http://www.sviluppoeconomico.gov.it/> for more details.

Questo prodotto è conforme alla specifiche di Interfaccia Radio Nazionali e rispetta il Piano Nazionale di ripartizione delle frequenze in Italia. Se non viene installato all'interno del proprio fondo, l'utilizzo di prodotti Wireless LAN richiede una "Autorizzazione Generale". Consultare <http://www.sviluppoeconomico.gov.it/> per maggiori dettagli.

Latvia

The outdoor usage of the 2.4 GHz band requires an authorization from the Electronic Communications Office. Please check <http://www.esd.lv> for more details.

2.4 GHz frekvenču joslas izmantošanai ārpus telpām nepieciešama atļauja no Elektronisko sakaru direkcijas. Vairāk informācijas: <http://www.esd.lv>.

Notes:

1. Although Norway, Switzerland and Liechtenstein are not EU member states, the EU Directive 1999/5/EC has also been implemented in those countries.
2. The regulatory limits for maximum output power are specified in EIRP. The EIRP level (in dBm) of a device can be calculated by adding the gain of the antenna used (specified in dBi) to the output power available at the connector (specified in dBm).

Safety Warnings

- Do NOT use this product near water, for example, in a wet basement or near a swimming pool.
- Do NOT expose your device to dampness, dust or corrosive liquids.
- Do NOT store things on the device.
- Do NOT install, use, or service this device during a thunderstorm. There is a remote risk of electric shock from lightning.
- Connect ONLY suitable accessories to the device.
- Do NOT open the device or unit. Opening or removing covers can expose you to dangerous high voltage points or other risks. ONLY qualified service personnel should service or disassemble this device. Please contact your vendor for further information.
- Make sure to connect the cables to the correct ports.
- Place connecting cables carefully so that no one will step on them or stumble over them.
- Always disconnect all cables from this device before servicing or disassembling.
- Use ONLY an appropriate power adaptor or cord for your device.
- Connect the power adaptor or cord to the right supply voltage (for example, 110V AC in North America or 230V AC in Europe).
- Do NOT allow anything to rest on the power adaptor or cord and do NOT place the product where anyone can walk on the power adaptor or cord.
- Do NOT use the device if the power adaptor or cord is damaged as it might cause electrocution.
- If the power adaptor or cord is damaged, remove it from the device and the power source.
- Do NOT attempt to repair the power adaptor or cord. Contact your local vendor to order a new one.
- Do not use the device outside, and make sure all the connections are indoors. There is a remote risk of electric shock from lightning.
- Do NOT obstruct the device ventilation slots, as insufficient airflow may harm your device.
- Use only No. 26 AWG (American Wire Gauge) or larger telecommunication line cord.
- Antenna Warning! This device meets ETSI and FCC certification requirements when using the included antenna(s). Only use the included antenna(s).

Your product is marked with this symbol, which is known as the WEEE mark. WEEE stands for Waste Electronics and Electrical Equipment. It means that used electrical and electronic products should not be mixed with general waste. Used electrical and electronic equipment should be treated separately.



Index

Numbers

802.1p [145](#)

A

activation

 CWMP [201](#)

 dynamic DNS [162](#)

 DYNDNS wildcard [162](#)

 NAT [148](#)

 port binding [158](#)

 port forwarding [151](#)

 QoS [138](#)

 SSID [94](#)

 wireless LAN

 scheduling [101](#)

 WPS [97](#)

address mapping

 types [155](#)

administrator password [19](#)

alternative subnet mask notation [251](#)

antenna

 directional [276](#)

 gain [276](#)

 omni-directional [276](#)

anti-probing [170](#)

AP (access point) [266](#)

applications, NAT [154](#)

Asynchronous Transfer Mode, see ATM

ATM [222](#)

 MBS [75, 79](#)

 PCR [74, 79](#)

 QoS [74, 79, 86](#)

 SCR [75, 79](#)

 status [222](#)

authentication [104, 105](#)

 RADIUS server [105](#)

automatic logout [20](#)

B

backup

 configuration [207](#)

Basic Service Set, See BSS [264](#)

Basic Service Set, see BSS

broadcast [69](#)

BSS [107, 264](#)

 example [107](#)

C

CA [189, 271](#)

CBR [74, 79, 86](#)

certificate

 factory default [190](#)

Certificate Authority

 See CA.

certificates [189](#)

 authentication [189](#)

 CA

 public key [189](#)

 replacing [190](#)

 storage space [190](#)

 trusted CAs [191](#)

Certification Authority [189](#)

Certification Authority. see CA

certifications [290](#)

 notices [291](#)

 viewing [291](#)

channel [266](#)

 interference [266](#)

channel, wireless LAN [103](#)

CLI [14](#)

client list [119](#)

Command Line Interface, see CLI

compatibility, WDS [99](#)

configuration

 backup [207](#)

- CWMP [200](#)
- DHCP [119](#)
- IP alias [121](#)
- IP precedence [143](#)
- IP/MAC filter [164](#)
- port forwarding [149](#)
- reset [208](#)
- restoring [208](#)
- static route [133, 135](#)
- WAN [69](#)
- wizard [28](#)
- connection
 - nailed-up [84](#)
- copyright [290](#)
- CPE WAN Management Protocol, see CWMP
- CTS (Clear to Send) [267](#)
- customized services [176, 178](#)
- CWMP [200](#)
 - activation [201](#)
 - configuration [200](#)

D

- data fragment threshold [101, 104](#)
- DDoS [169](#)
- default LAN IP address [19](#)
- default server address [152](#)
- default server, NAT [149](#)
- Denials of Service, see DoS
- DHCP [66, 116, 119, 128](#)
- diagnostic [221](#)
- DiffServ Code Point, see DSCP
- digital IDs [189](#)
- disclaimer [290](#)
- DMZ [152](#)
- DNS [116, 128, 217](#)
- documentation
 - related [2](#)
- Domain Name System, see DNS
- DoS [169](#)
 - three-way handshake [179](#)
 - thresholds [170, 179, 180](#)
- DSCP [143](#)
- DSL connections, status [223](#)

- dynamic DNS [161](#)
 - activation [162](#)
 - wildcard [161](#)
 - activation [162](#)
- Dynamic Host Configuration Protocol, see DHCP
- dynamic WEP key exchange [271](#)
- DYNDNS wildcard [161](#)
 - activation [162](#)

E

- EAP Authentication [270](#)
- encapsulation [68, 71, 78](#)
 - ENET ENCAP [83](#)
 - PPPoA [83](#)
 - PPPoE [83](#)
 - RFC 1483 [83](#)
- encryption [106, 272](#)
- ENET ENCAP [71, 78, 83](#)
- ESS [265](#)
- Extended Service Set IDentification [89, 95](#)
- Extended Service Set, See ESS [265](#)

F

- FCC interference statement [290](#)
- filters [163](#)
 - IP/MAC [163](#)
 - structure [163](#)
 - IP/MAC filter
 - configuration [164](#)
 - MAC address [96, 105](#)
 - URL [163](#)
- firewalls [168](#)
 - actions [175](#)
 - address types [176](#)
 - anti-probing [170](#)
 - customized services [176, 178](#)
 - DDoS [169](#)
 - default action [172](#)
 - DoS [169](#)
 - thresholds [170, 179, 180](#)
 - ICMP [170](#)
 - LAND attack [169](#)

- logs [175](#)
 - P2P [180](#)
 - packet direction [172](#)
 - Ping of Death [169](#)
 - rules [181](#)
 - security [182](#)
 - SYN attack [169](#)
 - three-way handshake [179](#)
 - triangle route [183](#)
 - solutions [184](#)
 - firmware [205](#)
 - forwarding ports [148, 149](#)
 - activation [151](#)
 - configuration [149](#)
 - example [149](#)
 - rules [150](#)
 - fragmentation threshold [101, 104, 267](#)
 - FTP [14, 213](#)
- ## G
- Guide
 - Quick Start [2](#)
- ## H
- hidden node [266](#)
 - host [199](#)
 - host name [65](#)
- ## I
- IANA [256](#)
 - Internet Assigned Numbers Authority
 - see IANA
 - IBSS [264](#)
 - ICMP [170, 217](#)
 - IEEE 802.11g [268](#)
 - IGA [153](#)
 - IGMP [69, 118, 130](#)
 - ILA [153](#)
 - importing trusted CAs [191](#)
 - Independent Basic Service Set
 - See IBSS [264](#)
 - initialization vector (IV) [273](#)
 - Inside Global Address, see IGA
 - Inside Local Address, see ILA
 - Internet Control Message Protocol, see ICMP
 - Internet Protocol version 6, see IPv6
 - IP address [65, 69, 72, 78, 84, 116, 129](#)
 - default [19](#)
 - default server [149](#)
 - ping [221](#)
 - private [129](#)
 - IP alias [120](#)
 - configuration [121](#)
 - NAT applications [155](#)
 - IP precedence [143, 145](#)
 - configuration [143](#)
 - IP/MAC filter [163](#)
 - configuration [164](#)
 - structure [163](#)
 - IPv6 [277](#)
 - addressing [277](#)
 - EUI-64 [279](#)
 - global address [278](#)
 - interface ID [279](#)
 - link-local address [277](#)
 - Neighbor Discovery Protocol [277](#)
 - ping [277](#)
 - prefix [277](#)
 - prefix length [277](#)
 - stateless autoconfiguration [279](#)
 - unspecified address [278](#)
- ## L
- LAN [115](#)
 - client list [119](#)
 - DHCP [116, 119, 128](#)
 - DNS [116, 128](#)
 - IGMP [130](#)
 - IP address [116, 117, 129](#)
 - IP alias [120](#)
 - configuration [121](#)
 - MAC address [120](#)
 - multicast [118, 130](#)
 - RIP [130](#)

- subnet mask [116, 129](#)
- LAND attack [169](#)
- limitations
 - wireless LAN [106](#)
 - WPS [113](#)
- Local Area Network, see LAN
- login
 - passwords [19](#)
- logout [20](#)
 - automatic [20](#)
- logs [194](#)
 - firewalls [175](#)

M

- MAC [65](#)
- MAC address [96, 120](#)
 - filter [96, 105](#)
- MAC authentication [96](#)
- Management Information Base (MIB) [215](#)
- managing the device
 - using FTP. See FTP.
- mapping address
 - types [155](#)
- Maximum Burst Size, see MBS
- Maximum Transmission Unit, see MTU
- MBS [75, 79, 85](#)
- MBSSID [107](#)
- Media Access Control, see MAC Address
- MLD proxy [74](#)
- model name [65](#)
- MTU [75, 80](#)
- multicast [69, 74, 118, 130](#)
 - IGMP/Internet Group Multicast Protocol, see IGMP
- Multiple BSS, see MBSSID
- multiplexing [71, 78, 83](#)
 - LLC-based [84](#)
 - VC-based [84](#)

N

- nailed-up connection [73, 84](#)

- NAT [78, 147, 153, 154, 255](#)
 - activation [148](#)
 - address mapping
 - types [155](#)
 - applications [154](#)
 - IP alias [155](#)
 - default server IP address [149](#)
 - example [154](#)
 - global [153](#)
 - IGA [153](#)
 - ILA [153](#)
 - inside [153](#)
 - local [153](#)
 - outside [153](#)
 - P2P [148](#)
 - port forwarding [148, 149](#)
 - activation [151](#)
 - configuration [149](#)
 - example [149](#)
 - rules [150](#)
 - remote management [211](#)
- Network Address Translation
 - see NAT
- Network Address Translation, see NAT
- network map [24](#)

O

- other documentation [2](#)

P

- P2P [148, 180](#)
- packet direction [172](#)
- Pairwise Master Key (PMK) [273, 274](#)
- passwords [19](#)
- PBC [108](#)
- PCR [74, 79, 85](#)
- Peak Cell Rate, see PCR
- PIN, WPS [109](#)
 - example [110](#)
- Ping of Death [169](#)
- port binding [157](#)
 - activation [158](#)

- summary screen [159](#)
- port forwarding [148, 149](#)
 - activation [151](#)
 - configuration [149](#)
 - example [149](#)
 - rules [150](#)
- PPPoA [71, 78, 83](#)
- PPPoE [71, 78, 83](#)
- preamble [101, 104](#)
- preamble mode [268](#)
- private IP address [129](#)
- probing, firewalls [170](#)
- product registration [291](#)
- PSK [273](#)
- push button [17](#)
- Push Button Configuration, see PBC
- push button, WPS [108](#)

Q

- QoS [136](#)
 - 802.1p [145](#)
 - activation [138](#)
 - DSCP [143](#)
 - example [136](#)
 - IP precedence [143, 145](#)
 - priority queue [146](#)
- Quality of Service, see QoS
- Quick Start Guide [2, 19](#)

R

- RADIUS [269](#)
 - message types [270](#)
 - messages [270](#)
 - shared secret key [270](#)
- RADIUS server [105](#)
- registration
 - product [291](#)
- related documentation [2](#)
- remote management [210](#)
 - DNS [217](#)
 - FTP [213](#)

- ICMP [217](#)
- limitations [211](#)
- NAT [211](#)
- SSH [218](#)
- Telnet [213](#)
- WWW [211](#)
- reset [18, 208](#)
- restart [209](#)
- restoring configuration [208](#)
- RFC 1483 [71, 78, 83](#)
- RFC 3164 [194](#)
- RIP [74, 130](#)
- Routing Information Protocol, see RIP
- RTS (Request To Send) [267](#)
 - threshold [266, 267](#)
- rules, port forwarding [150](#)

S

- schedules
 - wireless LAN [101](#)
- SCR [75, 79, 85](#)
- security
 - network [182](#)
 - wireless LAN [104](#)
- Security Parameter Index, see SPI
- Service Set [89, 95](#)
- setup
 - DHCP [119](#)
 - IP alias [121](#)
 - IP precedenceQoS
 - IP precedence [143](#)
 - IP/MAC filter [164](#)
 - port forwarding [149](#)
 - static route [133, 135](#)
 - WAN [69](#)
 - wizard [28](#)
- shaping traffic [85](#)
- Simple Network Management Protocol, see SNMP
- SNMP [214](#)
 - agents [215](#)
 - Manager [215](#)
 - managers [215](#)
 - MIB [215](#)
 - network components [215](#)

- versions [214](#)
- SPI [169](#)
- SSH [218](#)
- SSID [105](#)
 - activation [94](#)
 - MBSSID [107](#)
- static route [132](#)
 - configuration [133, 135](#)
 - example [132](#)
- status [63](#)
 - ATM [222](#)
 - DSL connections [223](#)
 - WPS [98](#)
- subnet [249](#)
- subnet mask [116, 129, 250](#)
- subnetting [252](#)
- Sustain Cell Rate, see SCR
- SYN attack [169](#)
- syslog
 - protocol [194](#)
 - severity levels [194](#)
- system [202](#)
 - firmware [205](#)
 - passwords [19](#)
 - reset [18](#)
 - status [63](#)
 - time [202](#)
- System Info [64](#)
- system name [65](#)

T

- Telnet [213](#)
- three-way handshake [179](#)
- thresholds
 - data fragment [101, 104](#)
 - DoS [170, 179, 180](#)
 - P2P [180](#)
- time [202](#)
- TR-069 [14](#)
- trademarks [290](#)
- traffic shaping [85](#)
 - example [85](#)
- triangle route [183](#)
 - solutions [184](#)

- trusted CAs, and certificates [191](#)

U

- UBR [74, 79, 86](#)
- unicast [69](#)
- Universal Plug and Play, see UPnP
- upgrading firmware [205](#)
- UPnP [121](#)
 - cautions [117](#)
 - NAT traversal [116](#)
- URL [163](#)
- URL filter
 - URL [163](#)

V

- VBR [86](#)
- VBR-nRT [74, 79, 86](#)
- VBR-RT [74, 79, 86](#)
- VCI [71, 78, 84](#)
- version
 - firmware
 - version [65](#)
- Virtual Channel Identifier, see VCI
- Virtual Path Identifier, see VPI
- VPI [71, 78, 84](#)

W

- WAN [68](#)
 - ATM QoS [74, 79, 86](#)
 - encapsulation [68, 71, 78](#)
 - IGMP [69](#)
 - IP address [69, 72, 78, 84](#)
 - mode [71, 78](#)
 - MTU [75, 80](#)
 - multicast [69, 74](#)
 - multiplexing [71, 78, 83](#)
 - nailed-up connection [73, 84](#)
 - NAT [78](#)
 - RIP [74](#)

- setup [69](#)
- traffic shaping [85](#)
 - example [85](#)
- VCI [71, 78, 84](#)
- VPI [71, 78, 84](#)
- warranty [291](#)
 - note [291](#)
- WDS [99, 108](#)
 - compatibility [99](#)
 - example [108](#)
- Web Configurator [19](#)
- web configurator [14](#)
 - passwords [19](#)
- WEP [106](#)
- WEP Encryption [91, 92](#)
- WEP encryption [91](#)
- WEP key [91](#)
- Wide Area Network, see WAN
- WiFi Protected Access [272](#)
- WiFi Protected Setup, see WPS
- wireless
 - client configuration [42](#)
 - wireless client WPA supplicants [273](#)
- Wireless Distribution System, see WDS
- wireless LAN [87, 102](#)
 - authentication [104, 105](#)
 - BSS [107](#)
 - example [107](#)
 - channel [103](#)
 - encryption [106](#)
 - example [103](#)
 - fragmentation threshold [101, 104](#)
 - limitations [106](#)
 - MAC address filter [96, 105](#)
 - MBSSID [107](#)
 - preamble [101, 104](#)
 - RADIUS server [105](#)
 - scheduling [101](#)
 - security [104](#)
 - SSID [105](#)
 - activation [94](#)
 - WDS [99, 108](#)
 - compatibility [99](#)
 - example [108](#)
 - WEP [106](#)
 - wizard [32](#)
 - WPA [106](#)
- WPA-PSK [106](#)
- WPS [97, 108, 110](#)
 - activation [97](#)
 - example [111](#)
 - limitations [113](#)
 - PIN [109](#)
 - push button [17, 108](#)
 - status [98](#)
- wireless security [268](#)
- Wireless tutorial [38](#)
- wizard [27](#)
 - configuration [28](#)
 - wireless LAN [32](#)
- WLAN
 - interference [266](#)
 - security parameters [275](#)
- WPA [106, 272](#)
 - key caching [273](#)
 - pre-authentication [273](#)
 - user authentication [273](#)
 - vs WPA-PSK [273](#)
 - wireless client supplicant [273](#)
 - with RADIUS application example [274](#)
- WPA2 [272](#)
 - user authentication [273](#)
 - vs WPA2-PSK [273](#)
 - wireless client supplicant [273](#)
 - with RADIUS application example [274](#)
- WPA2-Pre-Shared Key [272](#)
- WPA2-PSK [272, 273](#)
 - application example [274](#)
- WPA-PSK [106, 272, 273](#)
 - application example [274](#)
- WPS [97, 108, 110](#)
 - activation [97](#)
 - example [111](#)
 - limitations [113](#)
 - PIN [109](#)
 - example [110](#)
 - push button [17, 108](#)
 - status [98](#)