

**ADJUSTABLE PRECISION SHUNT REGULATORS****AZ431****General Description**

The AZ431 series ICs are three-terminal adjustable shunt regulators with guaranteed thermal stability over a full operation range. These ICs feature sharp turn-on characteristics, low temperature coefficient and low output impedance, which make them ideal substitutes for Zener diodes in applications such as switching power supply, charger and other adjustable regulators.

The AZ431 series ICs contain two voltage types, AZ431-A for 40V and AZ431-B for 20V. The output voltage of both types can be set to any value between $V_{REF}(2.5V)$ and the corresponding maximum cathode voltage.

The AZ431 precision reference is offered in two band-gap tolerance: 0.4% and 0.8%.

These ICs are available in 5 Packages: TO-92, SOT-23-3, SOT-23-5, SOT-89 and SOIC-8.

Features

- Programmable Precise Output Voltage from 2.5V to 36V or 18V
- Very Accurate Reference Voltage: 0.15% Typical
- High Stability under Capacitive Load
- Low Temperature Deviation: 4.5mV Typical
- Low Equivalent Full-range Temperature Coefficient with 20PPM/°C Typical
- Low Dynamic Output Resistance: 0.2Ω Typical
- Sink Current Capacity from 1mA to 100 mA
- Low Output Noise
- Wide Operating Range of -40 to 125°C

Applications

- Charger
- Voltage Adapter
- Switching Power Supply
- Graphic Card
- Precision Voltage Reference

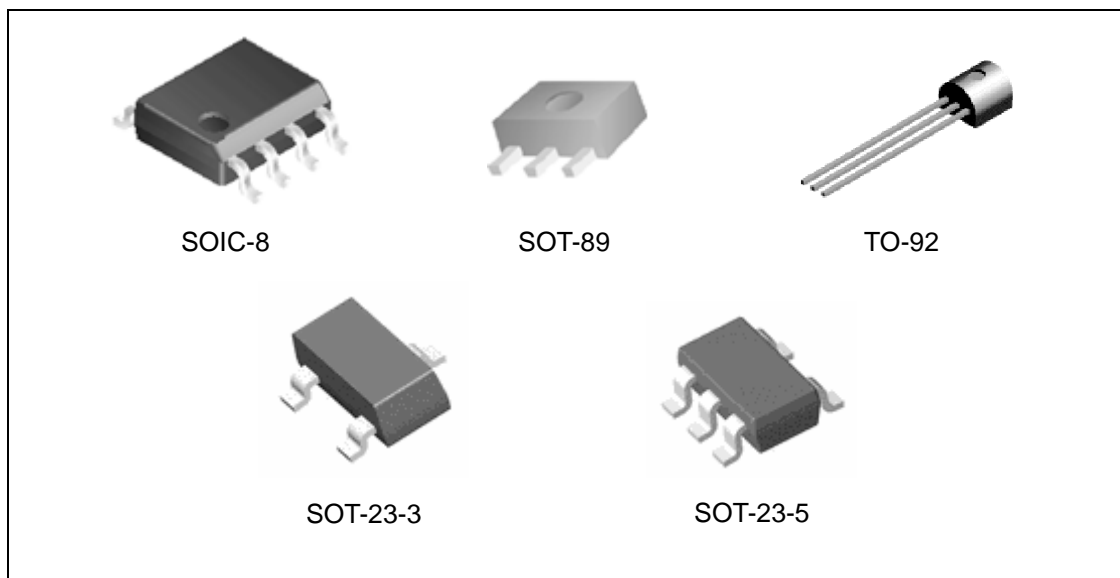

Figure 1. Package Types of AZ431



ADJUSTABLE PRECISION SHUNT REGULATORS

AZ431

Pin Configuration

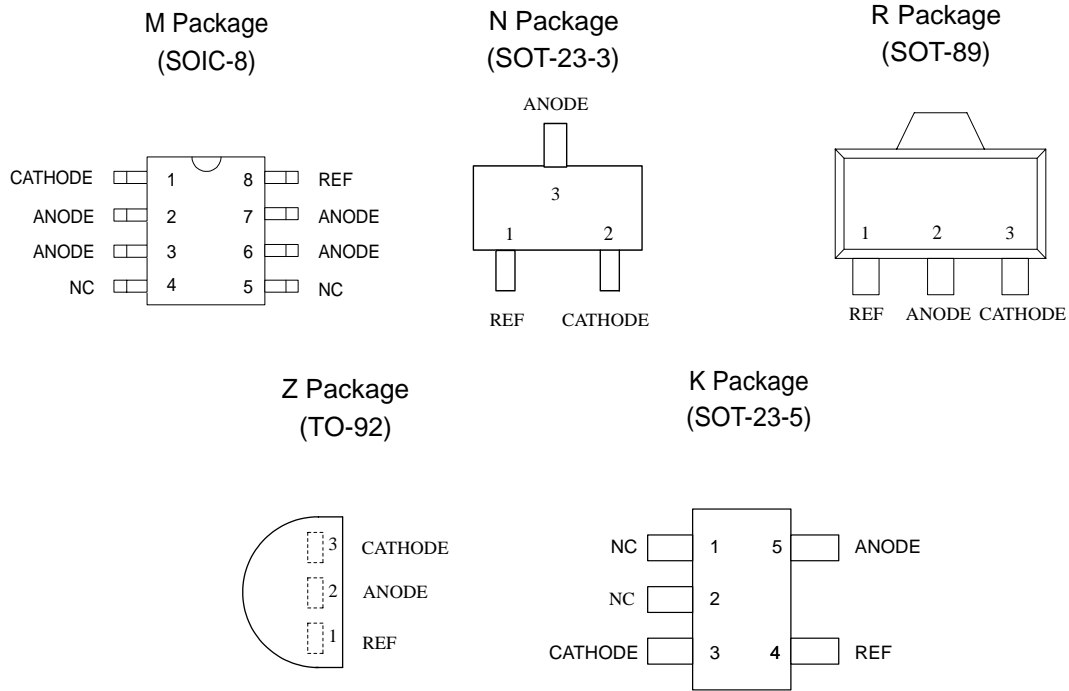

Figure 2. Pin Configuration of AZ431 (Top View)

Functional Block Diagram

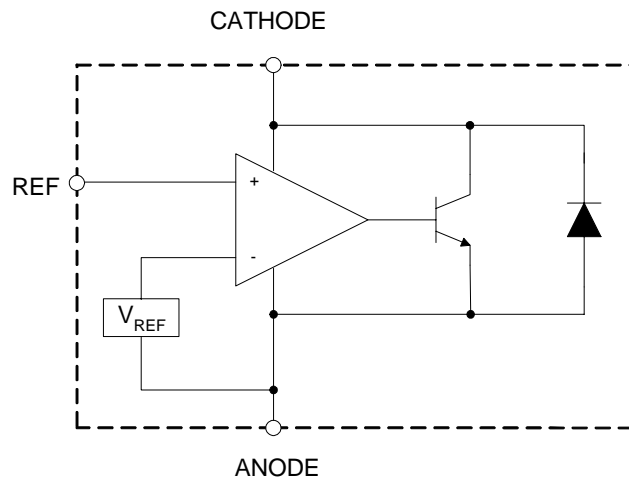

Figure 3. Functional Block Diagram of AZ431



ADJUSTABLE PRECISION SHUNT REGULATORS

AZ431

Ordering Information

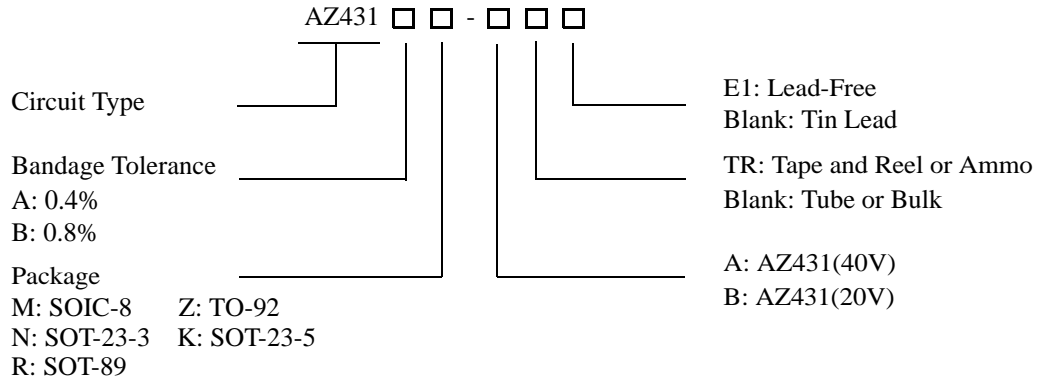

40V Products

Package	Temperature Range	Voltage Tolerance	Part Number		Marking ID		Packing Type
			Tin Lead	Lead Free	Tin Lead	Lead Free	
SOT-23-3	-40 to 125°C	0.4%	AZ431AN-ATR	AZ431AN-ATRE1	N41	EA1	Tape & Reel
		0.8%	AZ431BN-ATR	AZ431BN-ATRE1	N42	EA2	Tape & Reel
SOT-23-5	-40 to 125°C	0.4%	AZ431AK-ATR	AZ431AK-ATRE1	K3A	E3A	Tape & Reel
		0.8%	AZ431BK-ATR	AZ431BK-ATRE1	K3B	E3B	Tape & Reel
TO-92	-40 to 125°C	0.4%	AZ431AZ-A	AZ431AZ-AE1	AZ431AZ-A	AZ431AZ-AE1	Bulk
		0.4%	AZ431AZ-ATR	AZ431AZ-ATRE1	AZ431AZ-A	AZ431AZ-AE1	Ammo
		0.8%	AZ431BZ-A	AZ431BZ-AE1	AZ431BZ-A	AZ431BZ-AE1	Bulk
		0.8%	AZ431BZ-ATR	AZ431BZ-ATRE1	AZ431BZ-A	AZ431BZ-AE1	Ammo
SOIC-8	-40 to 125°C	0.4%	AZ431AM-A	AZ431AM-AE1	AZ431AM-A	AZ431AM-AE1	Tube
		0.4%	AZ431AM-ATR	AZ431AM-ATRE1	AZ431AM-A	AZ431AM-AE1	Tape & Reel
		0.8%	AZ431BM-A	AZ431BM-AE1	AZ431BM-A	AZ431BM-AE1	Tube
		0.8%	AZ431BM-ATR	AZ431BM-ATRE1	AZ431BM-A	AZ431BM-AE1	Tape & Reel
SOT-89	-40 to 125°C	0.4%	AZ431AR-ATR	AZ431AR-ATRE1	431A	E43A	Tape & Reel
		0.8%	AZ431BR-ATR	AZ431BR-ATRE1	431B	E43B	Tape & Reel



ADJUSTABLE PRECISION SHUNT REGULATORS

AZ431

Ordering Information (Continued)

20V Products

Package	Temperature Range	Voltage Tolerance	Part Number		Marking ID		Packing Type
			Tin Lead	Lead Free	Tin Lead	Lead Free	
SOT-23-3	-40 to 125°C	0.4%	AZ431AN-BTR	AZ431AN-BTRE1	N44	EA4	Tape & Reel
		0.8%	AZ431BN-BTR	AZ431BN-BTRE1	N45	EA5	Tape & Reel
SOT-23-5	-40 to 125°C	0.4%	AZ431AK-BTR	AZ431AK-BTRE1	K4A	E4A	Tape & Reel
		0.8%	AZ431BK-BTR	AZ431BK-BTRE1	K4B	E4B	Tape & Reel
TO-92	-40 to 125°C	0.4%	AZ431AZ-B	AZ431AZ-BE1	AZ431AZ-B	AZ431AZ-BE1	Bulk
		0.4%	AZ431AZ-BTR	AZ431AZ-BTRE1	AZ431AZ-B	AZ431AZ-BE1	Ammo
		0.8%	AZ431BZ-B	AZ431BZ-BE1	AZ431BZ-B	AZ431BZ-BE1	Bulk
		0.8%	AZ431BZ-BTR	AZ431BZ-BTRE1	AZ431BZ-B	AZ431BZ-BE1	Ammo
SOIC-8	-40 to 125°C	0.4%	AZ431AM-B	AZ431AM-BE1	AZ431AM-B	AZ431AM-BE1	Tube
		0.4%	AZ431AM-BTR	AZ431AM-BTRE1	AZ431AM-B	AZ431AM-BE1	Tape & Reel
		0.8%	AZ431BM-B	AZ431BM-BE1	AZ431BM-B	AZ431BM-BE1	Tube
		0.8%	AZ431BM-BTR	AZ431BM-BTRE1	AZ431BM-B	AZ431BM-BE1	Tape & Reel
SOT-89	-40 to 125°C	0.4%	AZ431AR-BTR	AZ431AR-BTRE1	431C	E43C	Tape & Reel
		0.8%	AZ431BR-BTR	AZ431BR-BTRE1	431D	E43D	Tape & Reel

BCD Semiconductor's Pb-free products, as designated with "E1" suffix in the part number, are RoHS compliant.

**ADJUSTABLE PRECISION SHUNT REGULATORS****AZ431****Absolute Maximum Ratings (Note 1)**

Parameter	Symbol	Value	Unit
Cathode Voltage	V_{KA}	AZ431 (40V): 40	V
		AZ431 (20V): 20	
Cathode Current Range (Continuous)	I_{KA}	-100 to +150	mA
Reference Input Current Range	I_{REF}	10	mA
Power Dissipation	P_D	M,Z,R Package: 770	mW
		N,K Package: 370	
Junction Temperature	T_J	160	°C
Storage Temperature Range	T_{STG}	-65 to +150	°C
Package Thermal Impedance	θ_{JA}	M Package: 150	°C/W
		N Package: 330	
		Z Package: 150	
		R Package: 50	
		K Package: 250	

Note 1: Stresses greater than those listed under "Absolute Maximum Ratings" may cause permanent damage to the device. These are stress ratings only, and functional operation of the device at these or any other conditions beyond those indicated under "Recommended Operating Conditions" is not implied. Exposure to "Absolute Maximum Ratings" for extended periods may affect device reliability.

Recommended Operating Conditions

Parameter	Symbol	Min	Max	Unit
Cathode Voltage	V_{KA}	V_{REF}	AZ431(40V): 36	V
			AZ431(20V): 18	
Cathode Current	I_{KA}	1.0	100	mA
Operating Ambient Temperature Range		-40	125	°C



ADJUSTABLE PRECISION SHUNT REGULATORS

AZ431

Electrical Characteristics for AZ431(40V)

Operating Conditions: $T_A=25^{\circ}\text{C}$ unless otherwise specified.

Parameter	Test Circuit	Symbol	Conditions	AZ431 (40V)			Unit	
				Min	Typ	Max		
Reference Voltage	0.4%	4	V_{REF}	$V_{KA}=V_{REF}, I_{KA}=10\text{mA}$	2.490	2.500	2.510	V
	0.8%				2.480	2.500	2.520	
Deviation of Reference Voltage Over-Temperature	4	ΔV_{REF}	$V_{KA}=V_{REF}$ $I_{KA}=10\text{mA}$	0 to 70°C	4.5	8	mV	
				-40 to 85°C	4.5	10		
Ratio of Change in Reference Voltage to the Change in Cathode Voltage	5	$\frac{\Delta V_{REF}}{\Delta V_{KA}}$	$I_{KA}=10\text{mA}$	$\Delta V_{KA}=10\text{V to }V_{REF}$	-1.0	-2.7	mV/V	
				$\Delta V_{KA}=36\text{V to }10\text{V}$	-0.5	-2.0		
Reference Current	5	I_{REF}	$I_{KA}=10\text{mA}, R1=10\text{K}\Omega, R2=\infty$		0.7	4	μA	
Deviation of Reference Current Over Full Temperature Range	5	ΔI_{REF}	$I_{KA}=10\text{mA}, R1=10\text{K}\Omega, R2=\infty, T_A=-40\text{ to }85^{\circ}\text{C}$		0.4	1.2	μA	
Minimum Cathode Current for Regulation	4	$I_{KA}(\text{MIN})$	$V_{KA}=V_{REF}$		0.4	1.0	mA	
Off-State Cathode Current	6	$I_{KA}(\text{OFF})$	$V_{KA}=36\text{V}, V_{REF}=0$		0.05	1.0	μA	
Dynamic Impedance	4	Z_{KA}	$V_{KA}=V_{REF}, I_{KA}=1\text{ to }100\text{mA}, f \leq 1.0\text{KHz}$		0.15	0.5	Ω	



ADJUSTABLE PRECISION SHUNT REGULATORS

AZ431

Electrical Characteristics for AZ431(20V)

Operating Conditions: $T_A=25^{\circ}\text{C}$ unless otherwise specified.

Parameter	Test Circuit	Symbol	Conditions	AZ431 (20V)			Unit	
				Min	Typ	Max		
Reference Voltage	0.4%	4	V_{REF}	$V_{KA}=V_{REF}, I_{KA}=10\text{mA}$	2.490	2.500	2.510	V
	0.8%				2.480	2.500	2.520	
Deviation of Reference Voltage Over-Temperature	4	ΔV_{REF}	$V_{KA}=V_{REF}$ $I_{KA}=10\text{mA}$	0 to 70°C	4.5	8	mV	
				-40 to 85°C	4.5	10		
Ratio of Change in Reference Voltage to the Change in Cathode Voltage	5	$\frac{\Delta V_{REF}}{\Delta V_{KA}}$	$I_{KA}=10\text{mA}$	$\Delta V_{KA}=10\text{V to }V_{REF}$	-1.0	-2.7	mV/V	
				$\Delta V_{KA}=18\text{V to }10\text{V}$	-0.5	-2.0		
Reference Current	5	I_{REF}	$I_{KA}=10\text{mA}, R1=10\text{K}\Omega, R2=\infty$		0.7	4	$\mu\text{ A}$	
Deviation of Reference Current Over Full Temperature Range	5	ΔI_{REF}	$I_{KA}=10\text{mA}, R1=10\text{K}\Omega, R2=\infty$ $T_A=-40\text{ to }85^{\circ}\text{C}$		0.4	1.2	$\mu\text{ A}$	
Minimum Cathode Current for Regulation	4	$I_{KA}(\text{MIN})$	$V_{KA}=V_{REF}$		0.4	1.0	mA	
Off-State Cathode Current	6	$I_{KA}(\text{OFF})$	$V_{KA}=18\text{V}, V_{REF}=0$		0.05	1.0	$\mu\text{ A}$	
Dynamic Impedance	4	Z_{KA}	$V_{KA}=V_{REF}, I_{KA}=1\text{ to }100\text{mA}$ $f \leq 1.0\text{KHz}$		0.2	0.5	Ω	



ADJUSTABLE PRECISION SHUNT REGULATORS

AZ431

Electrical Characteristics (Continued)

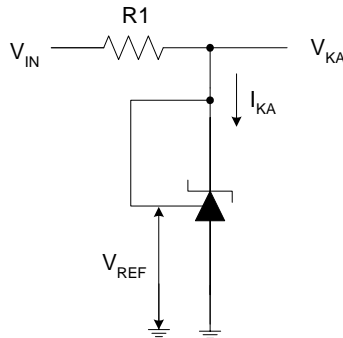

Figure 4. Test Circuit 4 for $V_{KA}=V_{ref}$

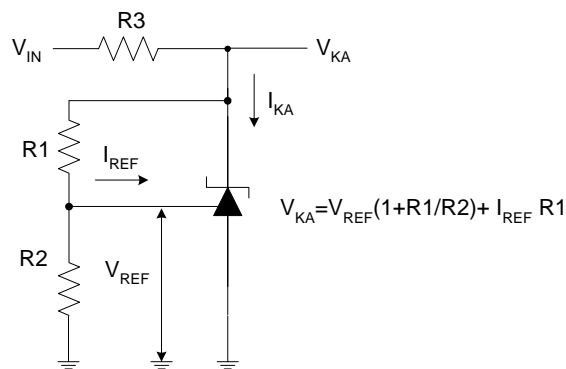

Figure 5. Test Circuit 5 for $V_{KA} > V_{ref}$

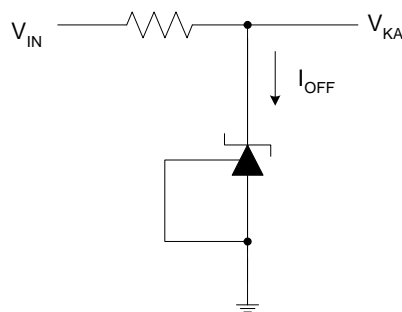

Figure 6. Test Circuit 6 for I_{OFF}



ADJUSTABLE PRECISION SHUNT REGULATORS

AZ431

Typical Performance Characteristics

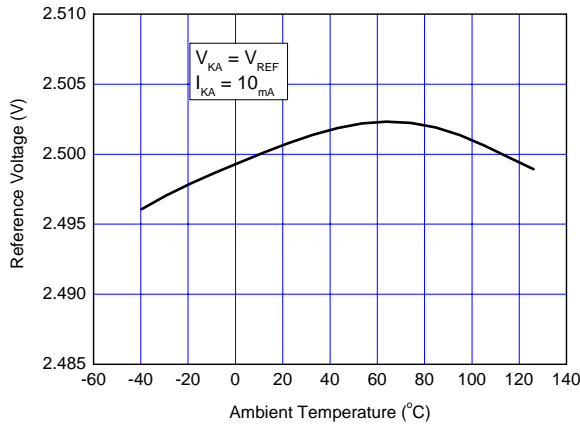

Figure 7. Reference Voltage vs. Ambient Temperature

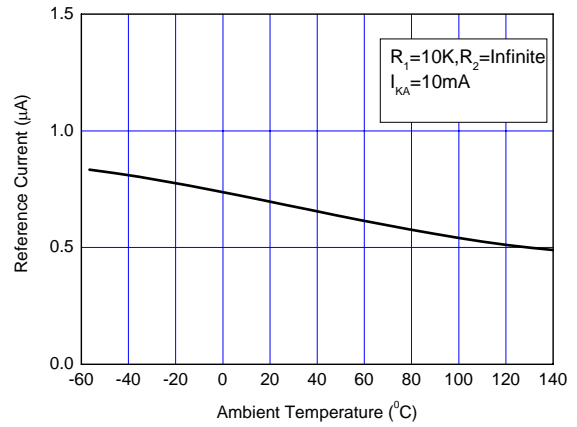

Figure 8. Reference Current vs. Ambient Temperature

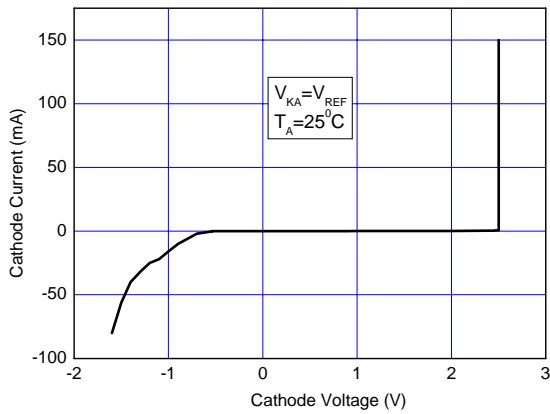

Figure 9. Cathode Current vs. Cathode Voltage

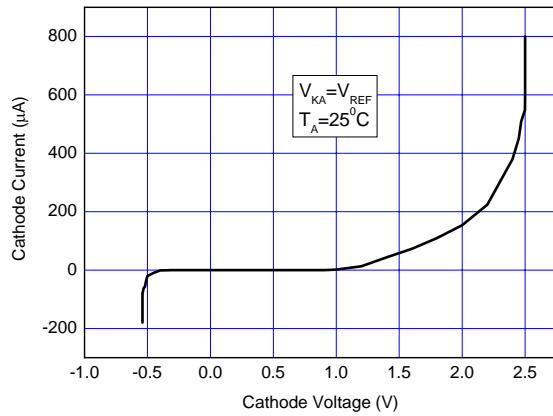

Figure 10. Current vs. Cathode Voltage



ADJUSTABLE PRECISION SHUNT REGULATORS

AZ431

Typical Performance Characteristics (Continued)

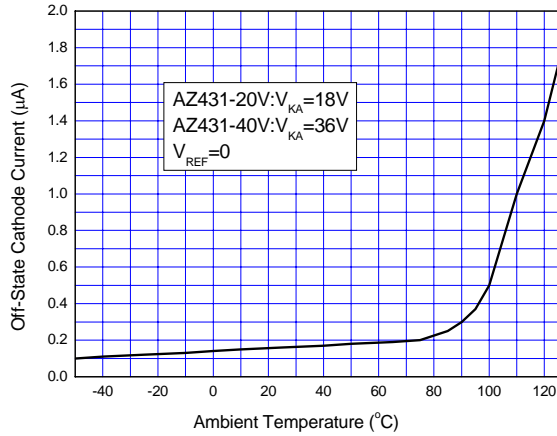

Figure 11. Off-state Cathode Current vs. Ambient Temperature

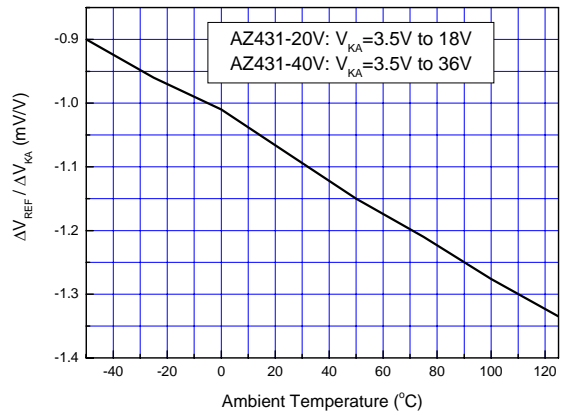

Figure 12. Ratio of Delta Reference Voltage to the Ratio of Delta Cathode Voltage

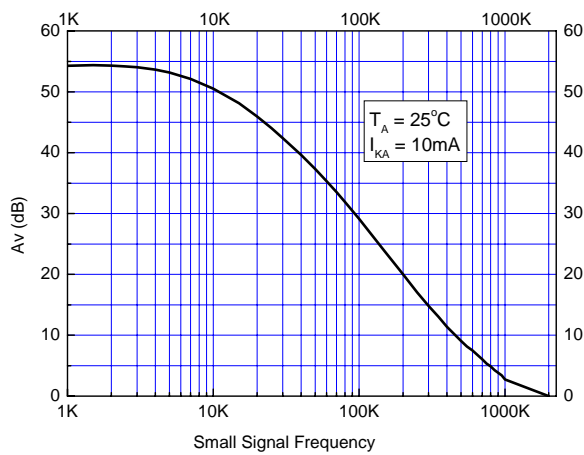
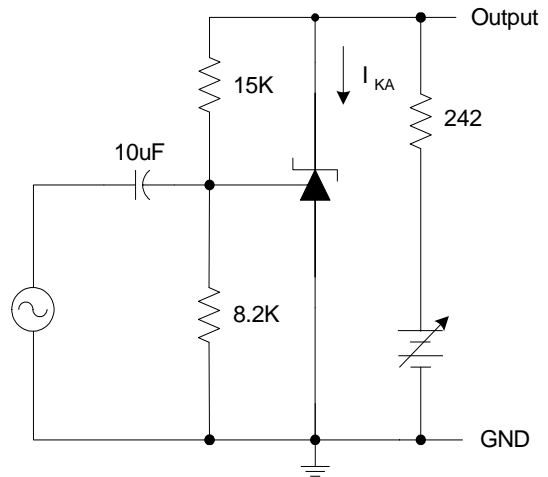

Figure 13. Small Signal Voltage Gain vs. Frequency





ADJUSTABLE PRECISION SHUNT REGULATORS

AZ431

Typical Performance Characteristics (Continued)

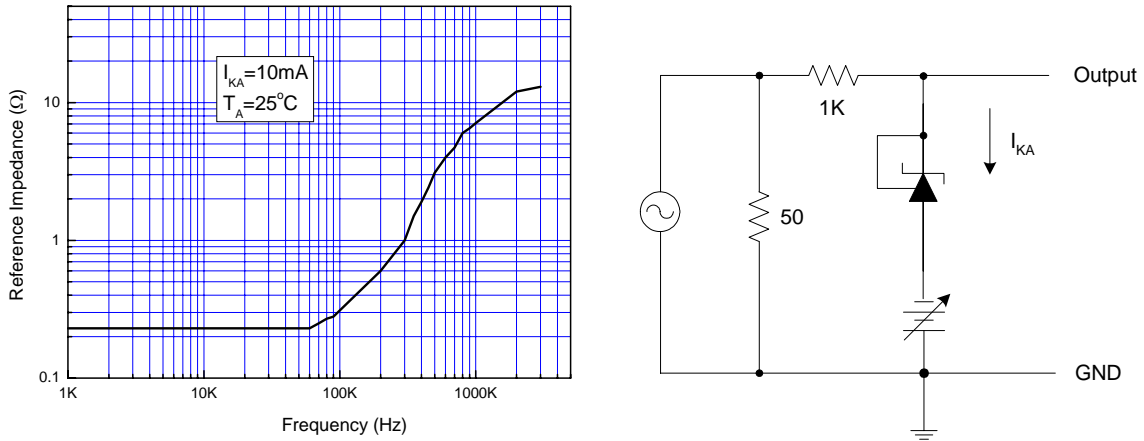

Figure 14. Reference Impedance vs. Frequency

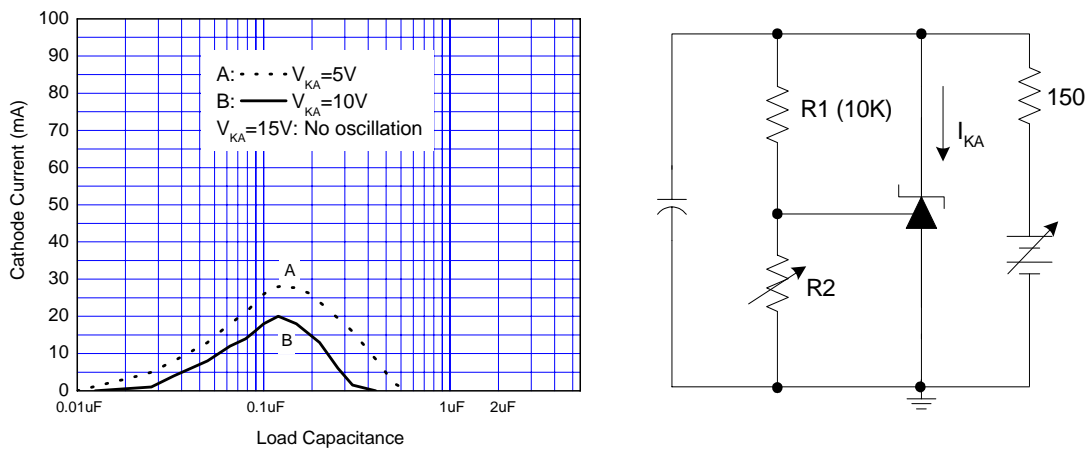

Figure 15. Stability Boundary Conditions vs. Load Capacitance



ADJUSTABLE PRECISION SHUNT REGULATORS

AZ431

Typical Performance Characteristics (Continued)

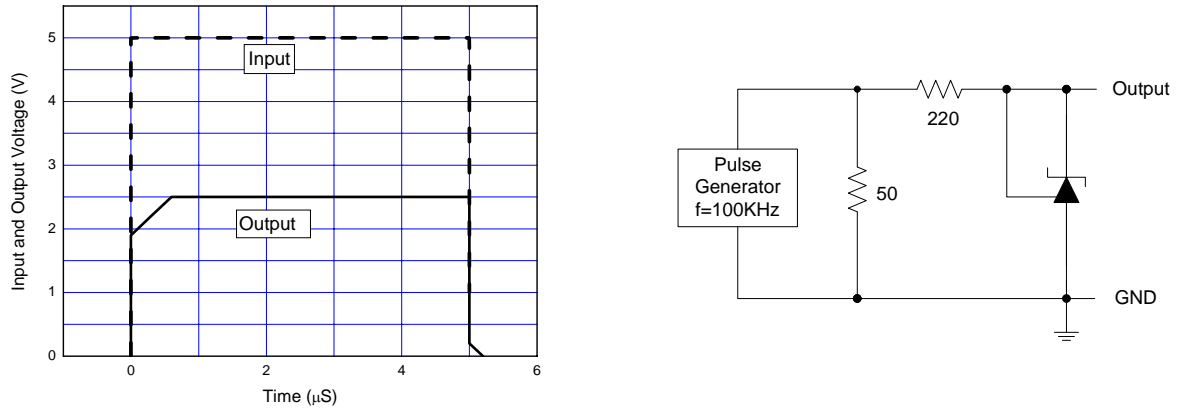

Figure 16. Pulse Response of Input and Output Voltage



ADJUSTABLE PRECISION SHUNT REGULATORS

AZ431

Typical Application

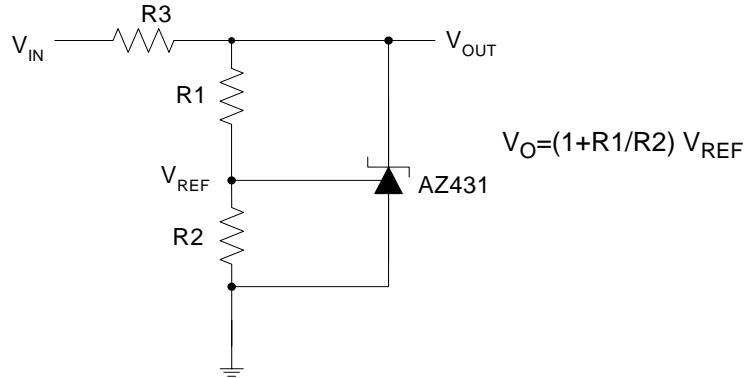

Figure 17. Shunt Regulator

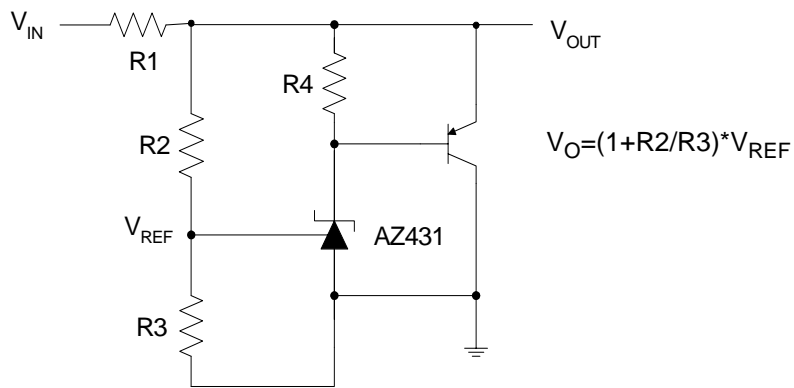

Figure 18. High Current Shunt Regulator

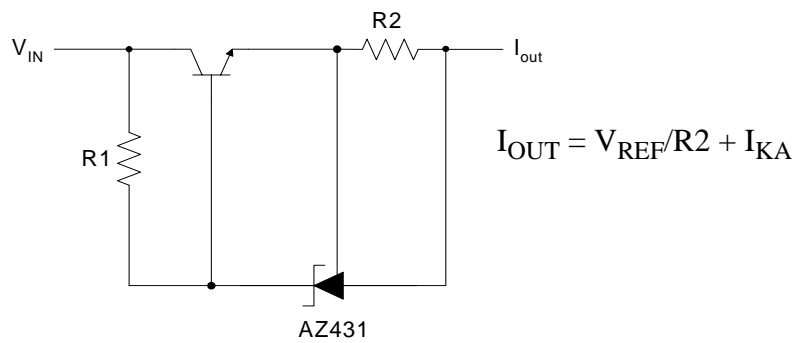

Figure 19. Current Source or Current Limit



ADJUSTABLE PRECISION SHUNT REGULATORS

AZ431

Typical Application (Continued)

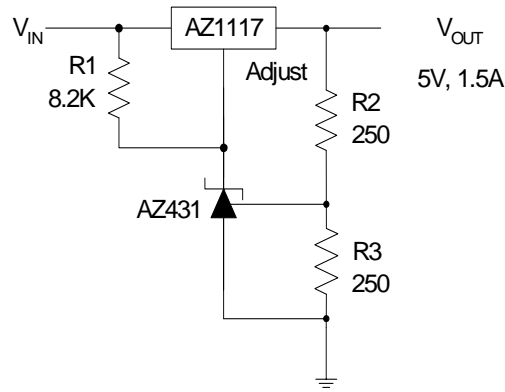

Figure20. Precision 5V 1.5A Regulator

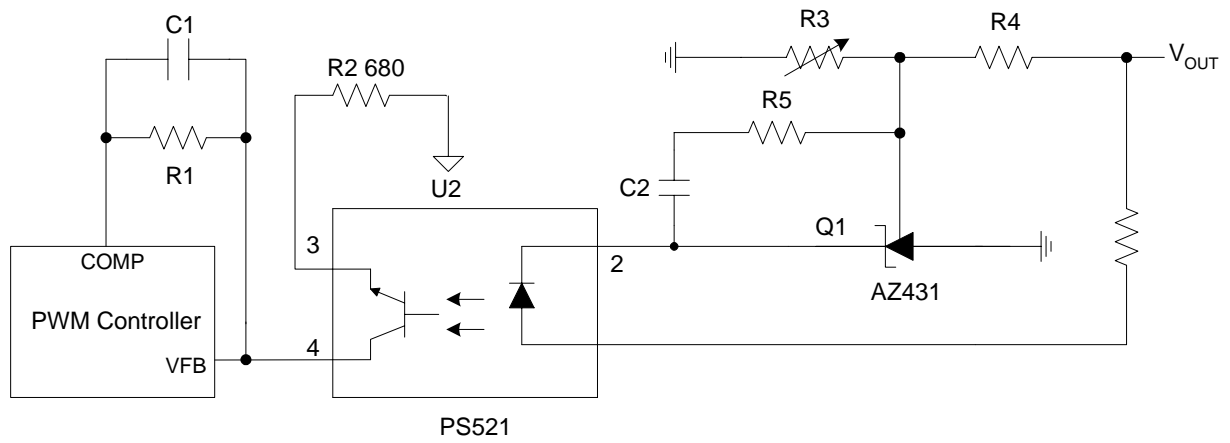

Figure 21. PWM Converter with Reference



ADJUSTABLE PRECISION SHUNT REGULATORS

AZ431

Mechanical Dimensions

TO-92

Unit: mm (inch)

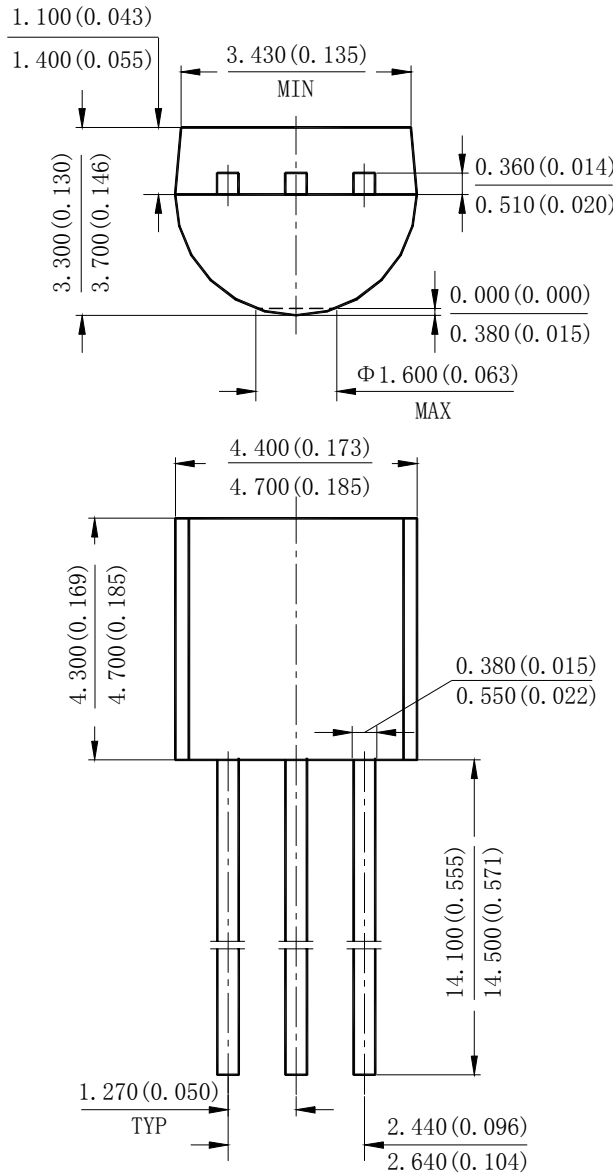



ADJUSTABLE PRECISION SHUNT REGULATORS

AZ431

Mechanical Dimensions (Continued)

SOT-23-3

Unit: mm(inch)

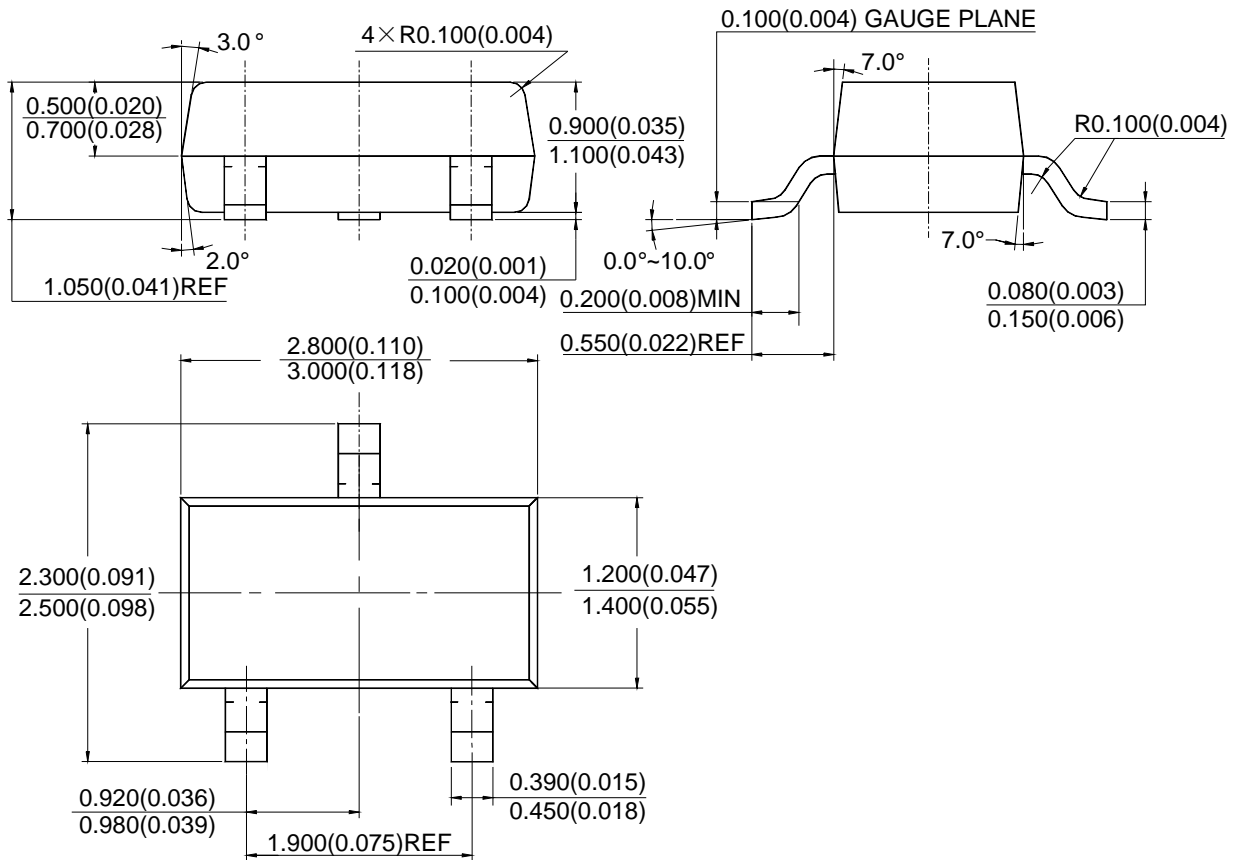



ADJUSTABLE PRECISION SHUNT REGULATORS

AZ431

Mechanical Dimensions (Continued)

SOT-23-5

Unit: mm(inch)

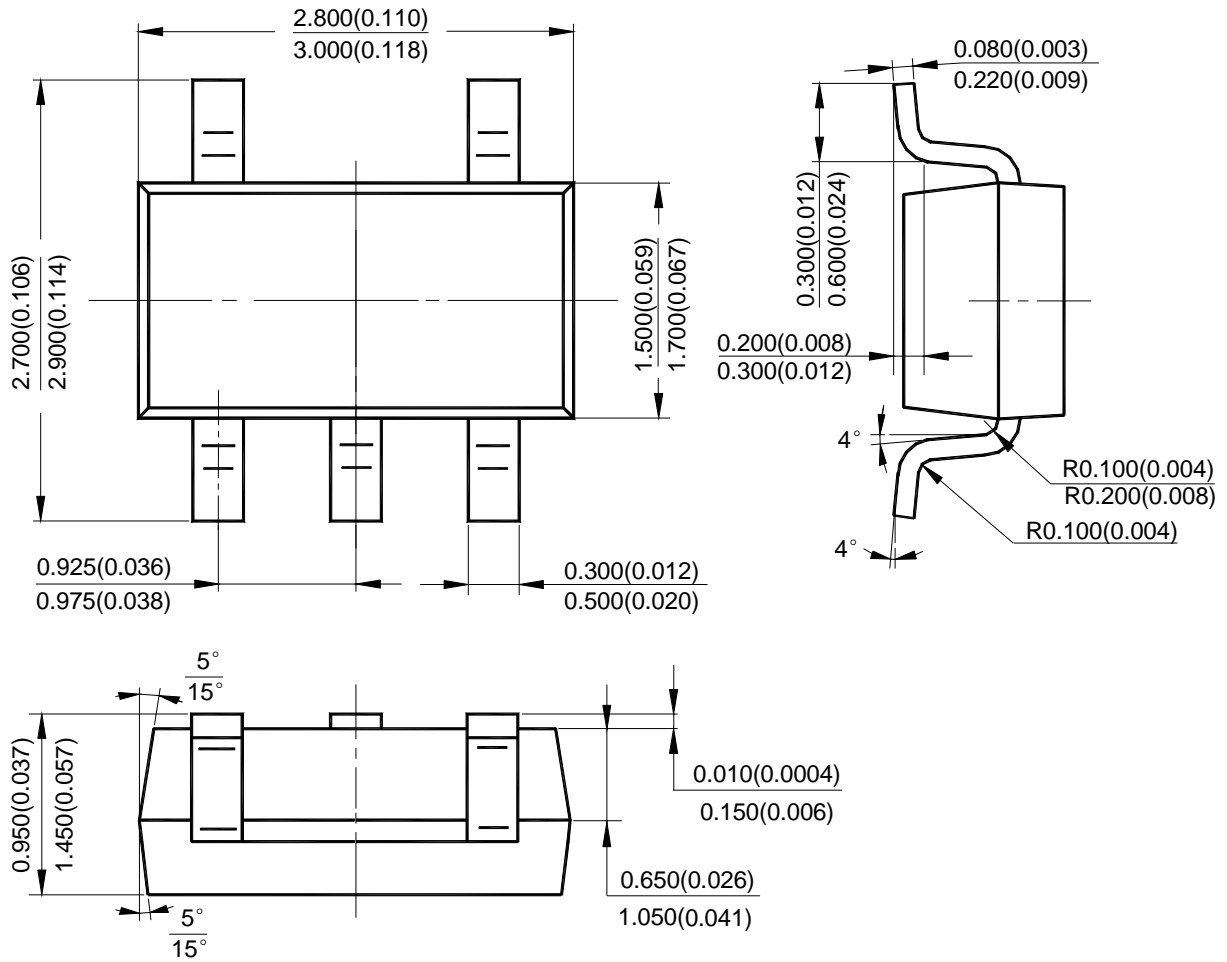



ADJUSTABLE PRECISION SHUNT REGULATORS

AZ431

Mechanical Dimensions (Continued)

SOT-89

Unit: mm(inch)

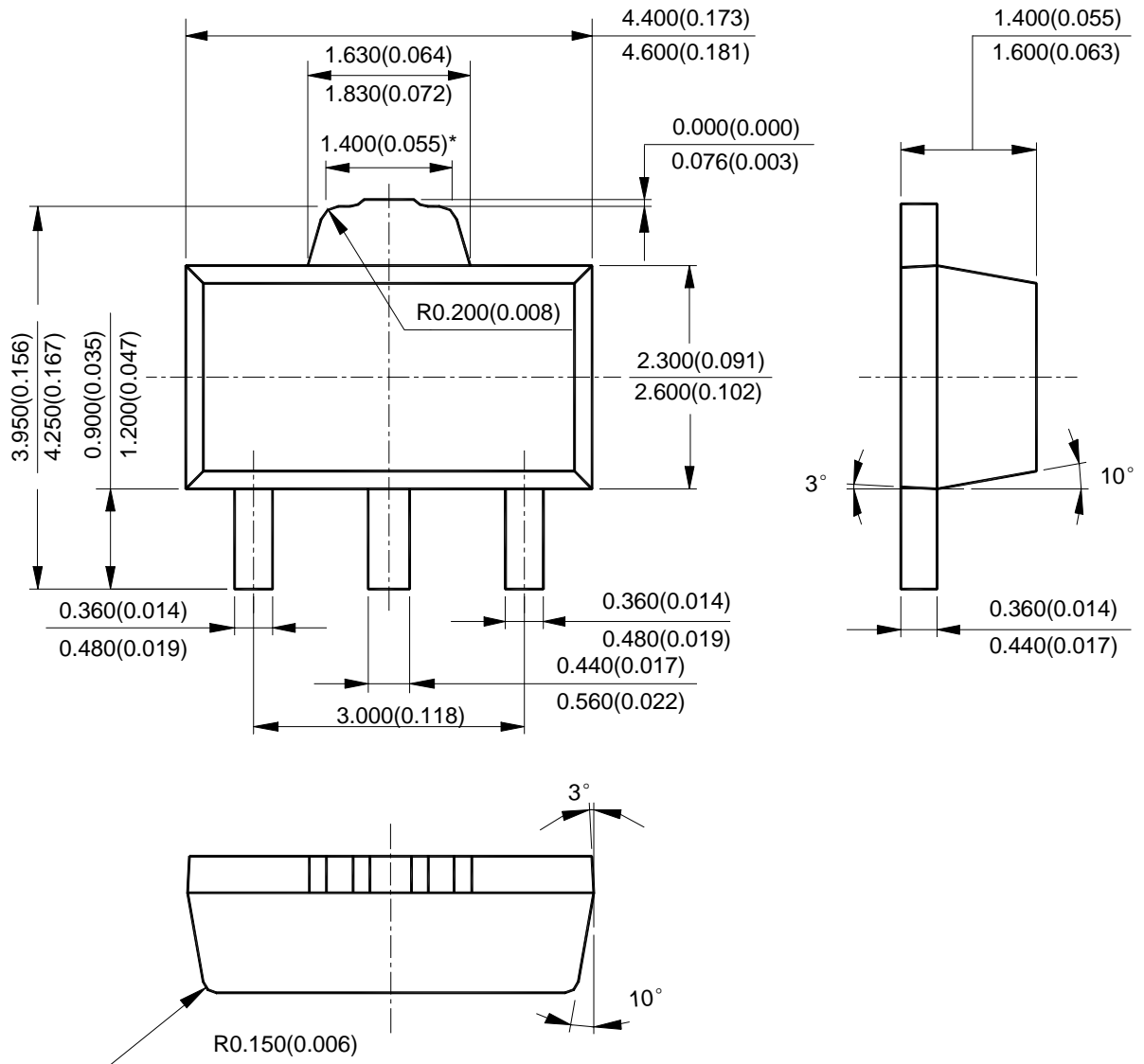



ADJUSTABLE PRECISION SHUNT REGULATORS

AZ431

Mechanical Dimensions (Continued)

SOIC-8

Unit: mm(inch)

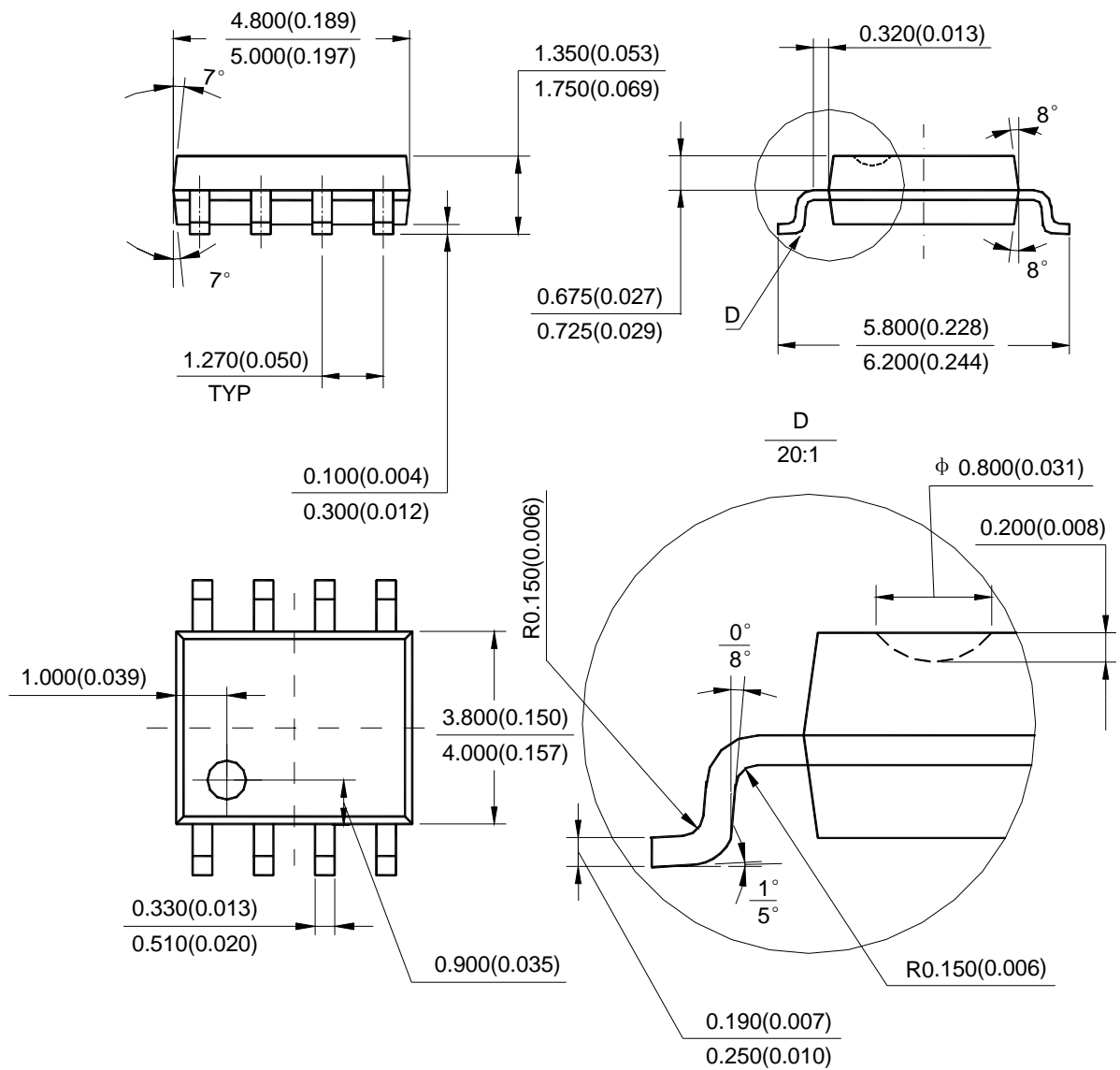



BCD Semiconductor Manufacturing Limited

<http://www.bcdsemi.com>

BCD Semiconductor Corporation

3170 De La Cruz Blvd, Suite # 105 Santa Clara, CA 95054-2411, U.S.A

Tel: +1-408-988 6388, Fax: +1-408-988 6386

Shanghai SIM-BCD Semiconductor Manufacturing Co., Ltd.

800 Yi Shan Road, Shanghai 200233, PRC

Tel: +86-21-6485-1491, Fax: +86-21-5450-0008

Advanced Analog Circuits (Shanghai) Corporation

8F, B Zone, 900 Yi Shan Road, Shanghai 200233, PRC

Tel: +86-21-6495 9539, Fax: +86-21-6485 9673

BCD Semiconductor (Taiwan) Company Limited

Room 2210, 22nd Fl, 333, Keelung Road, Sec. 1, TaiPei (110), Taiwan

Tel: +886-2-2758 6828, Fax: +886-2-2758 6892

IMPORTANT NOTICE

BCD Semiconductor Manufacturing Limited reserves the right to make changes without further notice to any products or specifications herein. BCD Semiconductor Manufacturing Limited does not assume any responsibility for use of any its products for any particular purpose, nor does BCD Semiconductor Manufacturing Limited assume any liability arising out of the application or use of any its products or circuits. BCD Semiconductor Manufacturing Limited does not convey any license under its patent rights or other rights nor the rights of others.